

IMMUNOASSAYS

Use antibodies for analytical purposes

Most used type of assay that use a label to have an analytical signal

- **Radio immunoassay (a radioactive label, i.e I_{125} for thiroyd hormones)**
- **Fluorimetric assays (a fluorescent label, i.e fluorescein)**
- **Chemiluminometric assays (a chemiluminescent label is used)**
- **Enzyme immunoassays (or ELISA) (an enzyme is the label and the product of the reaction can be detected colorimetrically, fluorimetrically or by chemiluminescence)**

Enzyme Linked Immuno-Sorbent Assay (ELISA)

Types of ELISA

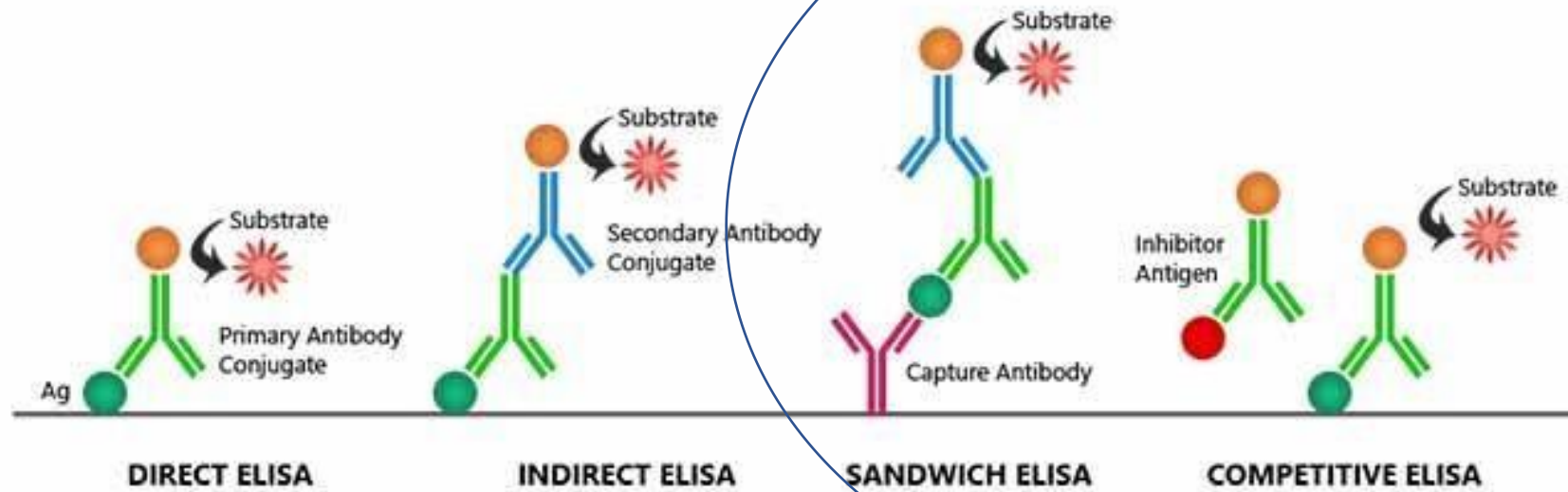

quantitative

Antigeni (Ag)

- **L'antigene è una sostanza capace di interagire in maniera specifica con i prodotti finali della risposta immunitaria (anticorpi).**
- **L'immunogeno è quella sostanza che, dopo essere penetrata nei tessuti di un vertebrato superiore, è in grado di indurre una specifica risposta di difesa immunitaria con formazione di uno o più anticorpi.**
- **La capacità di indurre una risposta immunitaria e/o cellulare, coinvolgendo cellule del sistema reticolo-linfocitario, viene definita immunogenicità.**
- **Attenzione: non tutti gli antigeni hanno capacità immunogenica (ad es. piccole molecole PM <3000 Da) .**
- **Gli antigeni interagiscono con gli anticorpi utilizzando piccole zone superficiali specifiche dette determinanti antigenici o epitopi.**

- **Attenzione (!): in alcuni casi antigenicità ed immunogenicità vengono usati come sinonimi.**

Antibodies

- Proteins secreted by B-lymphocytes (type of white blood cell), in vertebrates.

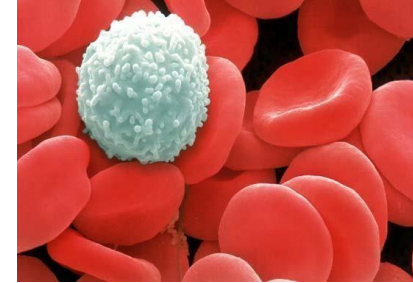

- Recognise and bind to molecules (**antigens**) on foreign particles, marking them for destruction by T-lymphocytes.

- Each antigen may generate several antibodies for different sites (**epitopes**) on antigen.

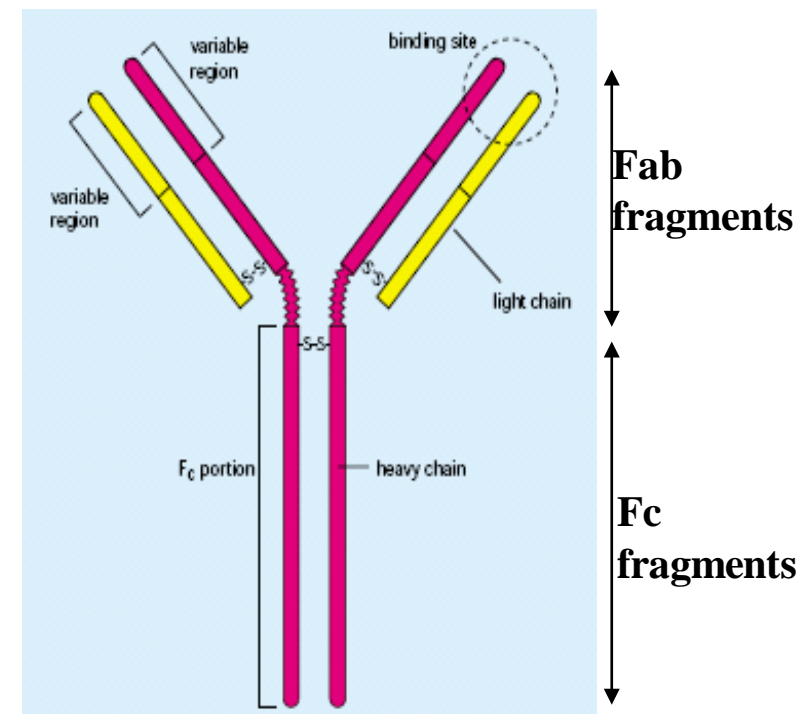

IgG molecule

Anticorpi

- Gli anticorpi o immunoglobuline (Ig) sono una famiglia di glicoproteine plasmatiche, appartenenti alla classe delle Y-globuline,
- Vengono prodotti dai linfociti B maturi, appartenenti alla categoria dei globuli bianchi, che hanno il compito di difendere l'organismo da agenti esterni tramite la risposta umorale.

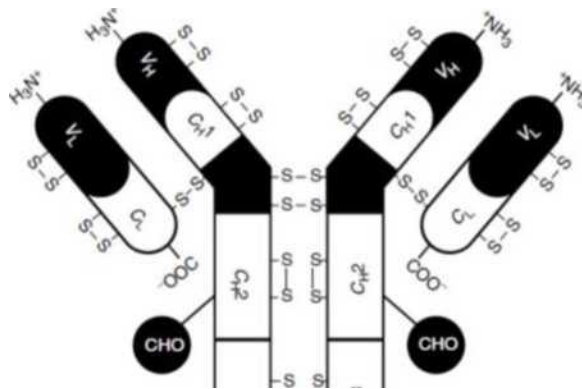

Anticorpo (Ab)

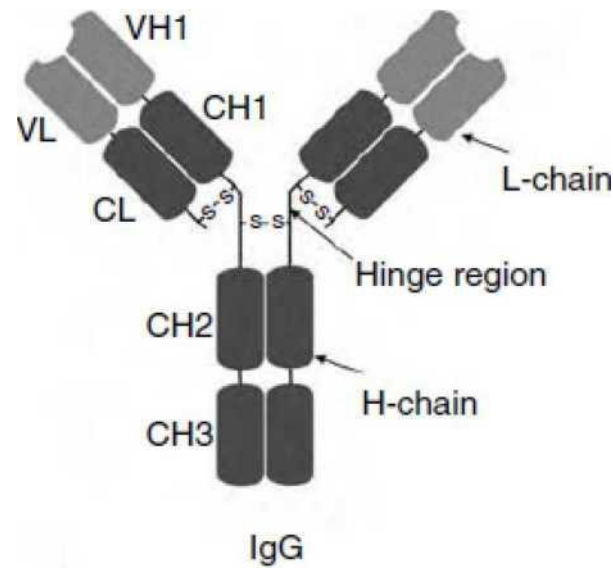

2 catene pesanti (H-chain) ca. 50 kDa

2 catene leggere (L-chain) ca. 26 kDa

Domini variabili: V_H e V_L

Domini costanti: C_H e C_L

Le H-chain definiscono l'isotipo (o classe)

anticorpale: IgA, IgD, IgE, **IgG**, IgM

Antibody - Antigen interaction

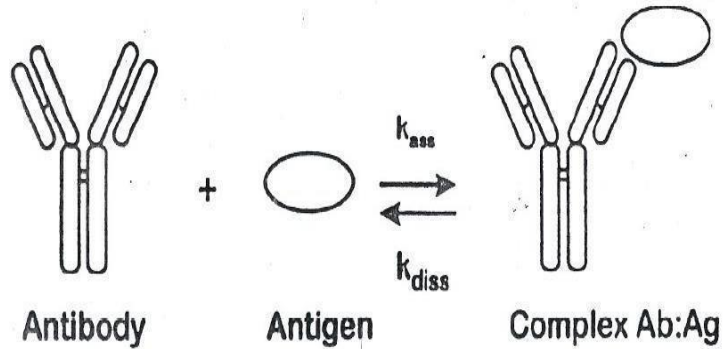

$$v = \frac{d[\text{Ab:Ag}]}{dt} = k_{\text{ass}} [\text{Ab}][\text{Ag}] - k_{\text{diss}} [\text{Ab:Ag}]$$

Equilibrium: $\frac{d[\text{Ab:Ag}]}{dt} = 0$ and $K_{\text{aff}} = \frac{k_{\text{ass}}}{k_{\text{diss}}} = \frac{[\text{Ab:Ag}]}{[\text{Ab}][\text{Ag}]}$

- Non - covalent
- Highly specific
- $k_{\text{ass}} \approx 10^6 - 10^8 \text{ M}^{-1}\text{s}^{-1}$
- $k_{\text{diss}} \approx 10^{-1} - 10^{-4} \text{ s}^{-1}$
- $K_{\text{aff}} \approx 10^6 - 10^{12} \text{ M}^{-1}$

Double Antibody Sandwich Immunoassay

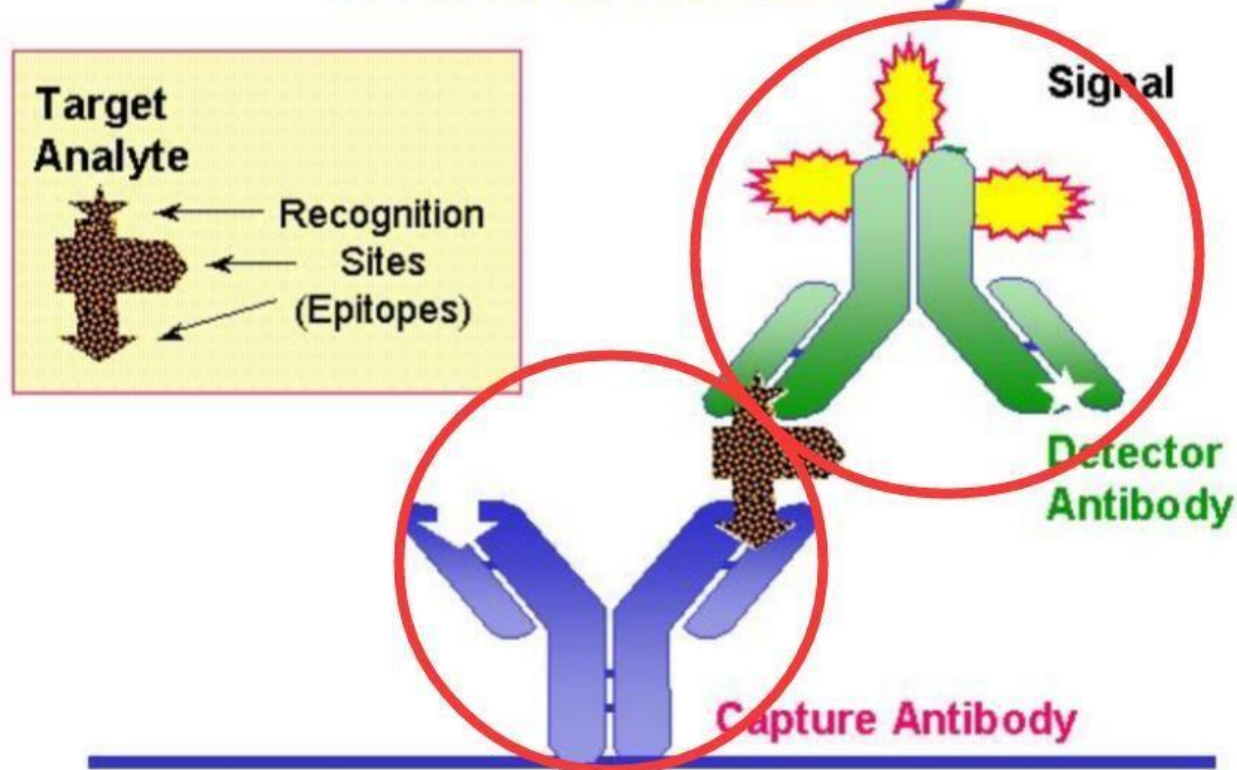

Dosaggio di un allergene (proteina) di arachide

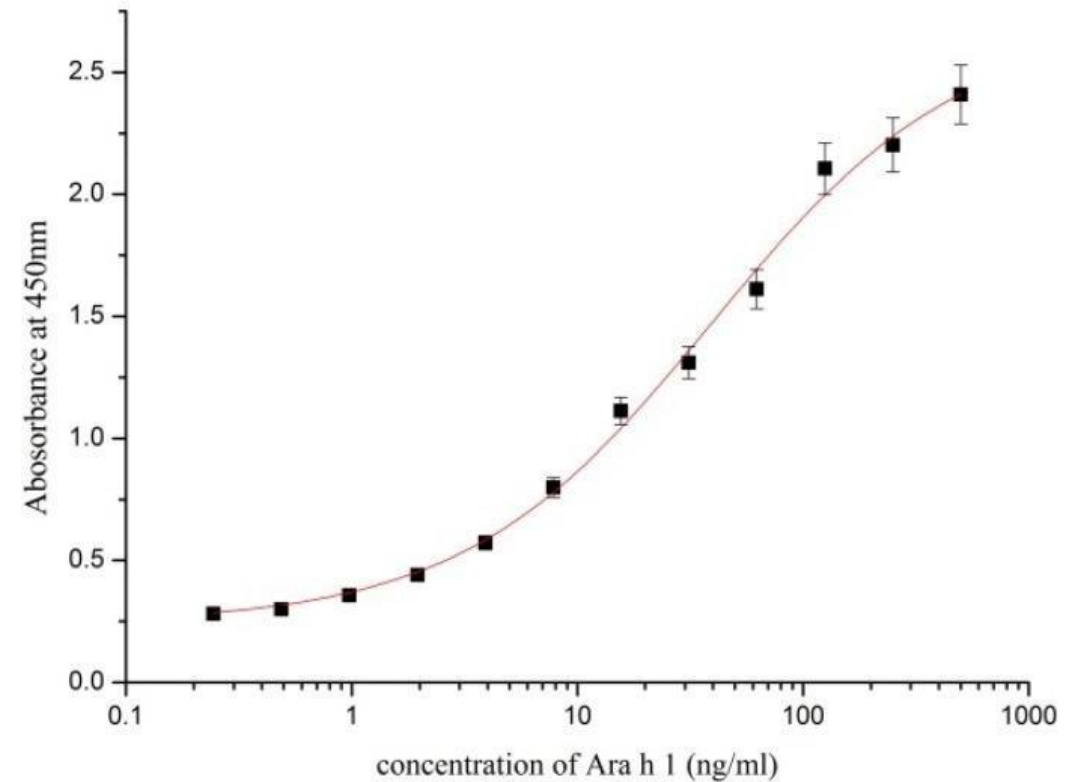

Tumor necrosis factor alpha (TNF- α), also known as cachectin and TNFSF1A, is the prototypic ligand of the TNF superfamily (1). It is a pleiotropic molecule that plays a central role in inflammation, immune system development, apoptosis, and lipid metabolism (2-5). TNF- α is also involved in a number of pathological conditions including asthma, Crohn's disease, rheumatoid arthritis, neuropathic pain, obesity, type 2 diabetes, septic shock, autoimmunity, and cancer (5-11).

Human TNF- α is synthesized as a 26 kDa type II transmembrane protein that consists of a 35 amino acid (aa) cytoplasmic domain, a 21 aa transmembrane segment, and a 177 aa extracellular domain (ECD) (12, 13). Within the ECD, human TNF- α shares 97% aa sequence

This assay employs the quantitative sandwich enzyme immunoassay technique. A monoclonal antibody specific for TNF- α has been pre-coated onto a microplate. Standards and samples are pipetted into the wells and any TNF- α present is bound by the immobilized antibody. After washing away any unbound substances, an enzyme-linked polyclonal antibody specific for TNF- α is added to the wells. Following a wash to remove any unbound antibody-enzyme reagent, a substrate solution is added to the wells and color develops in proportion to the amount of TNF- α bound in the initial step. The color development is stopped and the intensity of the color is measured.

Create a standard curve by reducing the data using computer software capable of generating a four parameter logistic (4-PL) curve fit. As an alternative, construct a standard curve by plotting the mean absorbance for each standard on the y-axis against the concentration on the x-axis and draw a best fit curve through the points on the graph. The data may be linearized by plotting the log of the TNF- α concentrations versus the log of the O.D. and the best fit line can be determined by regression analysis. This procedure will produce an adequate but less precise fit of the data.

Segnale vs. log concentrazione maggiore accuratezza!!

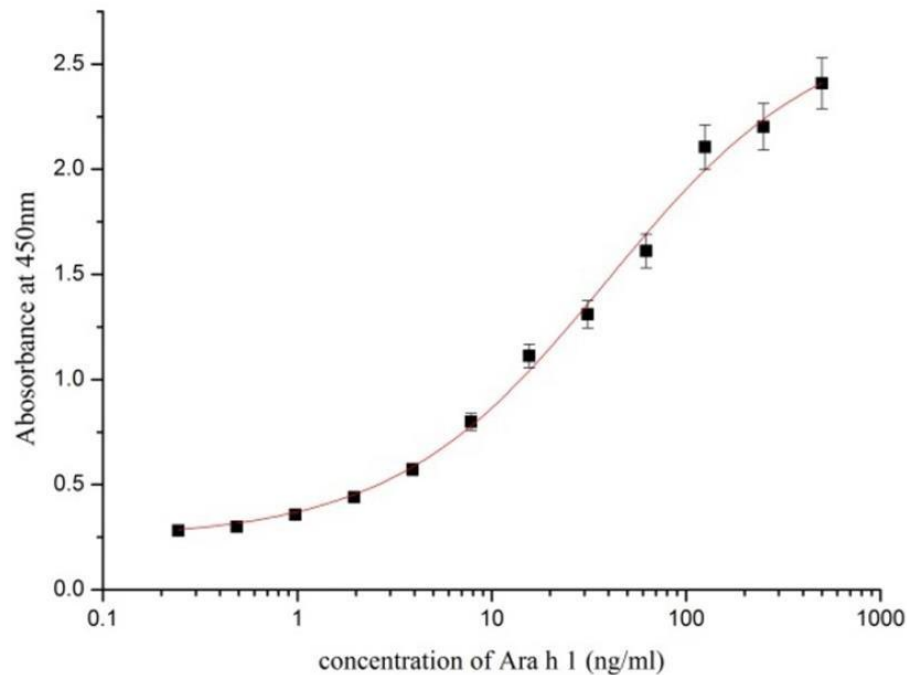

CALIBRATOR DILUENT RD6-35

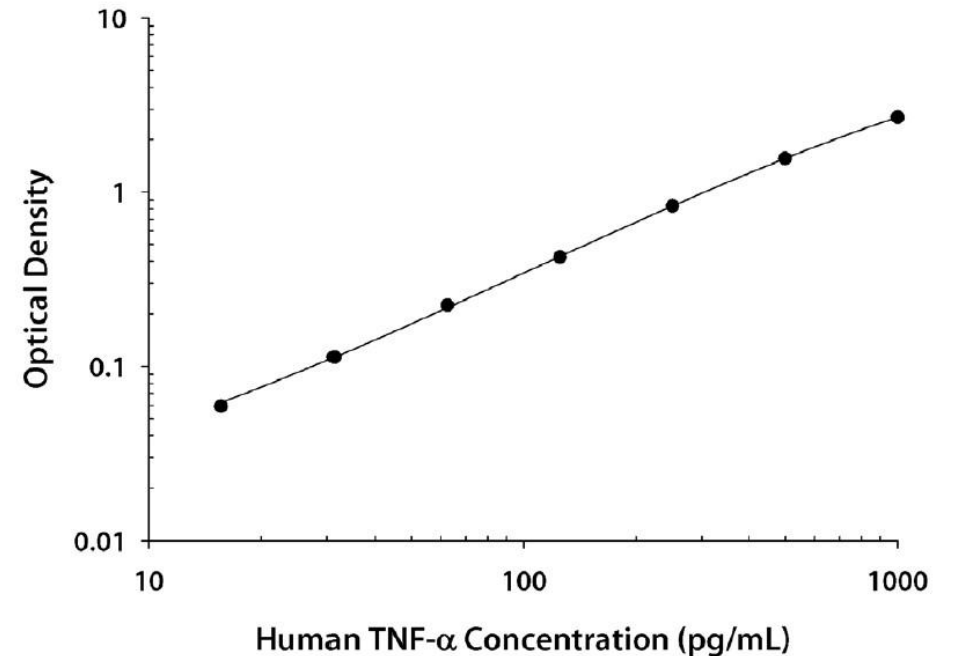

Competitive immunoassays

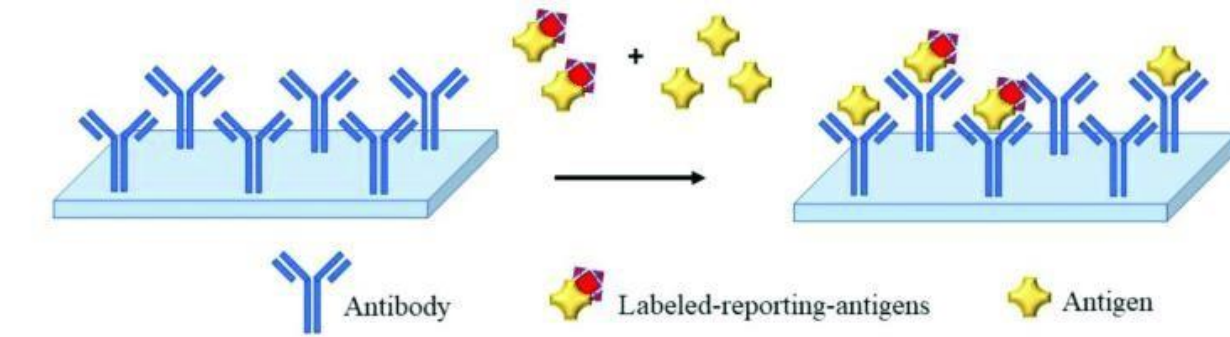

(a)

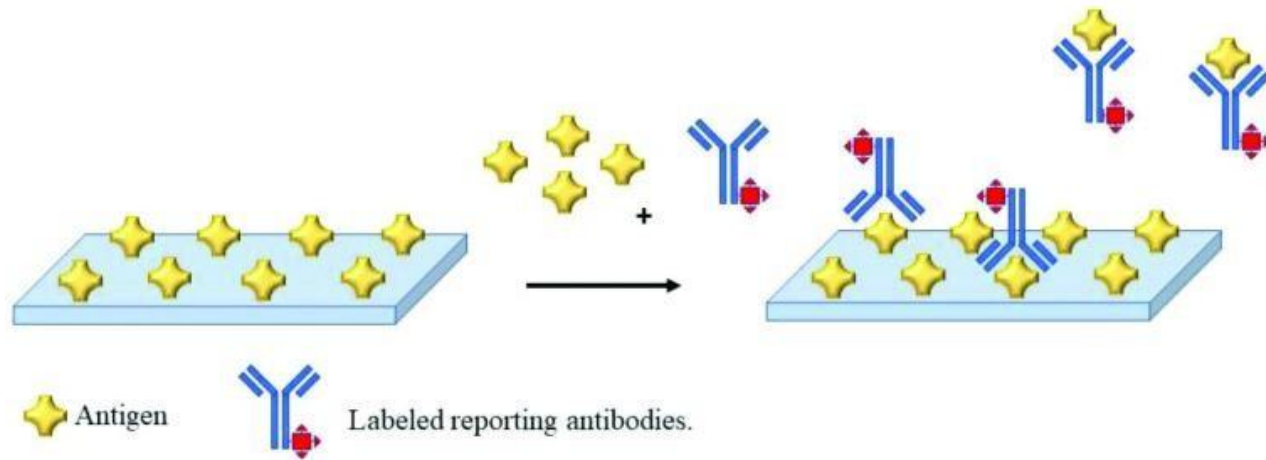

(b)

Calibration curve for ethopabate (veterinary drug)

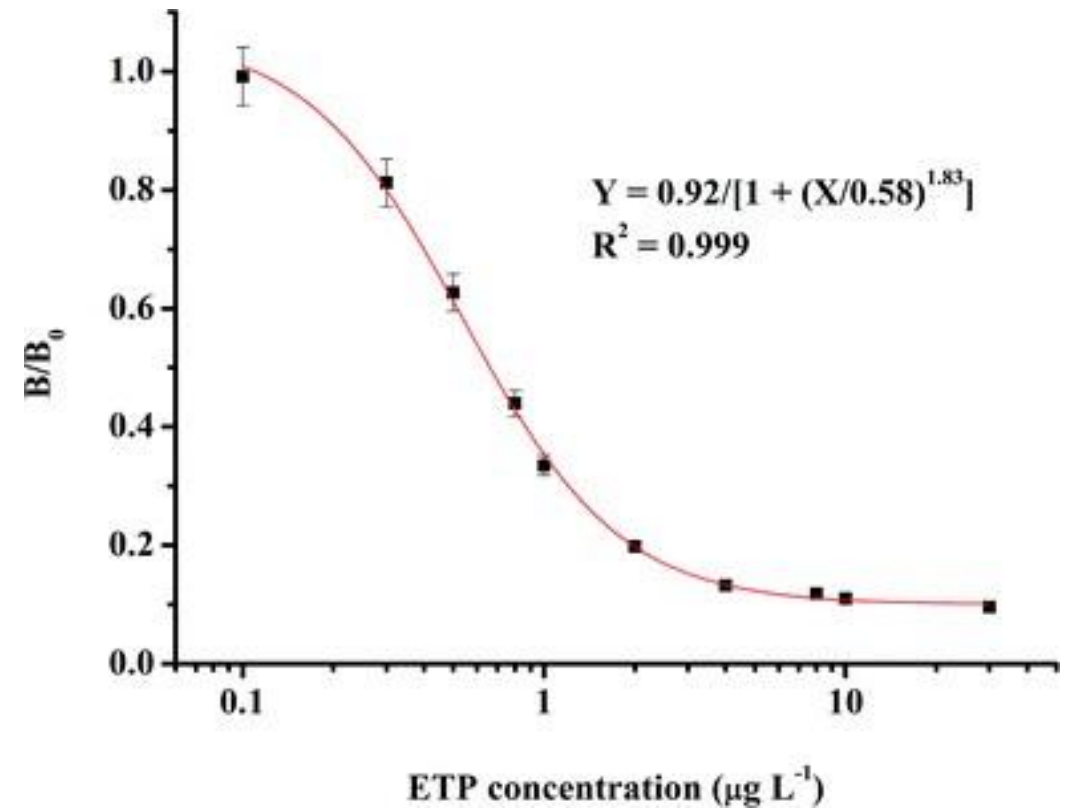

$$y = \frac{a-d}{(1+(x/c)^b)} + d$$

a = (theoretical) response at low concentration/dilution
b = absolute value of the slope at the inflection point
c = value of x at inflection point
d = (theoretical) response at high concentration/dilution
x = concentration or dilution
y = response (OD)

Typical calibration curve for immunoassay

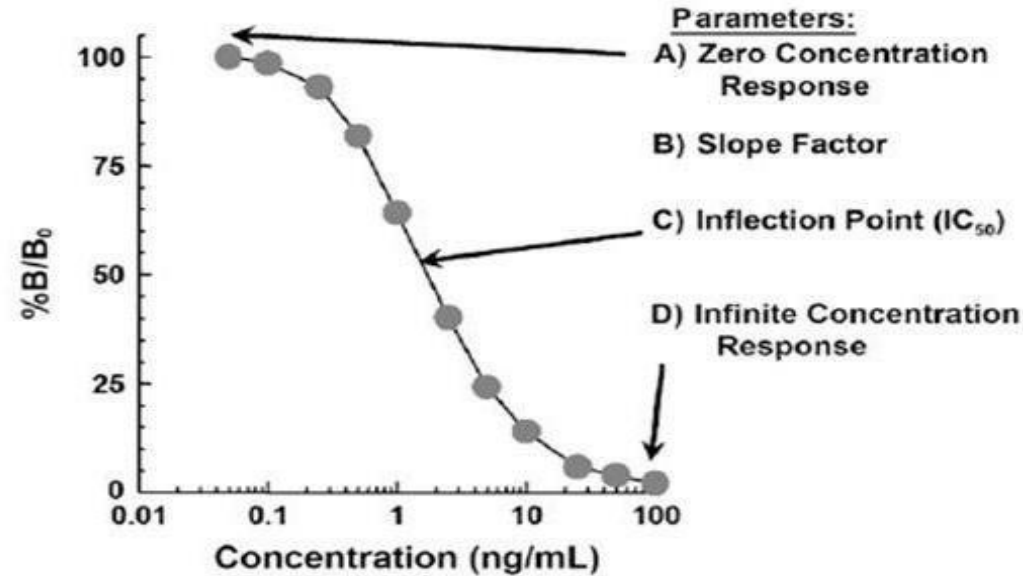

Figure 1. Typical 4-parameter logistic graph for a competitive-format immunoassay.

Enzymes of ELISA

| Enzyme* | Source | Specific Enzyme activity (units Δ /mg) |
|------------------------------------|---------------------------|---|
| Alkaline phosphatase | Calf intestine | 400 |
| Beta Galactosidase | E.coli | 400 |
| Glucose oxidase | Aspergillus Niger | 200 |
| Glucose -6-phosphate dehydrogenase | Leucon Stoc mesenteroides | 250 |
| Peroxidase | Horseradish | 900 |

Δ A unit of Enzyme activity represents the conversion of 1 μ mol of Enzyme substrate to product per minute.

ENZYME SUBSTRATE

- Initially the substrate should be colorless
- After degradation by the enzyme it should be strongly colored or fluorescent.

| ENZYME | SUBSTRATE | CHROMOGEN | STOPPING |
|-------------------------|-------------------------------|---|------------------------------------|
| Alkaline Phosphatase | p-NPP | p-NPP+ diethandamine+Mg Cl ₂ | 1 M NaOH |
| Horse radish Peroxidase | H ₂ O ₂ | Tetramethylbenzidine + Phosphate – Citrate buffer | 1 M H ₂ SO ₄ |
| Horse radish Peroxidase | H ₂ O ₂ | O – Phenylenediamine + HCl | 1 M HCl |

14

COATING

Polystyrene plate is treated with a solution of either antigen or antibody.

remove liquid and wash plate

BLOCKING

An unrelated protein-based solution is used to cover all unbound sites on the plates

remove liquid and wash plate

DETECTION

Enzyme-conjugated antibody or antigen binds specifically to the target antigen or antibody

remove liquid and wash plate

READ RESULTS

Substrate is added and the signal produced by the enzyme-substrate reaction is measured



Horseradish peroxidase and alkaline phosphatase retain high activity when conjugated with antibodies or antigens and have different types of substrates useful for different assays



À la carte ELISA Systems

| | | | | |
|---|--|---|---|---|
|  |  |  |  |  |
| Almond | Beta-Lactoglobulin | Buckwheat | Casein | Crustacean |
|  |  |  |  |  |
| Egg | Gluten | Hazelnut | Lupin | Mustard |
|  |  |  | | |
| Peanut | Sesame | Soy | | |

Polyclonal antibodies production

1 Inject antigen into rabbit.

2 Antigen activates B cells.

3 Plasma B cells produce polyclonal antibodies.

4 Obtain antiserum from rabbit containing polyclonal antibodies.

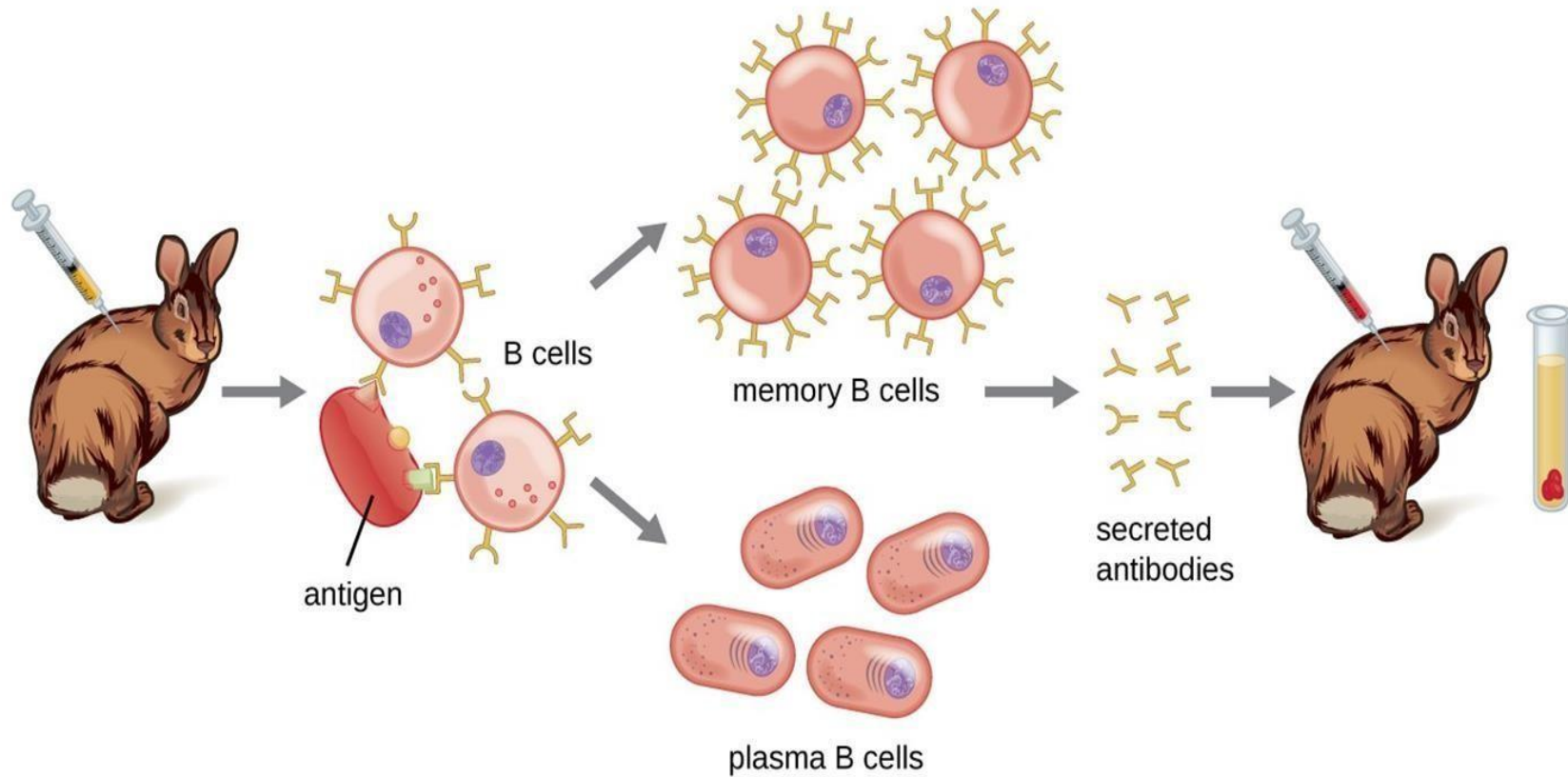

Monoclonal antibodies

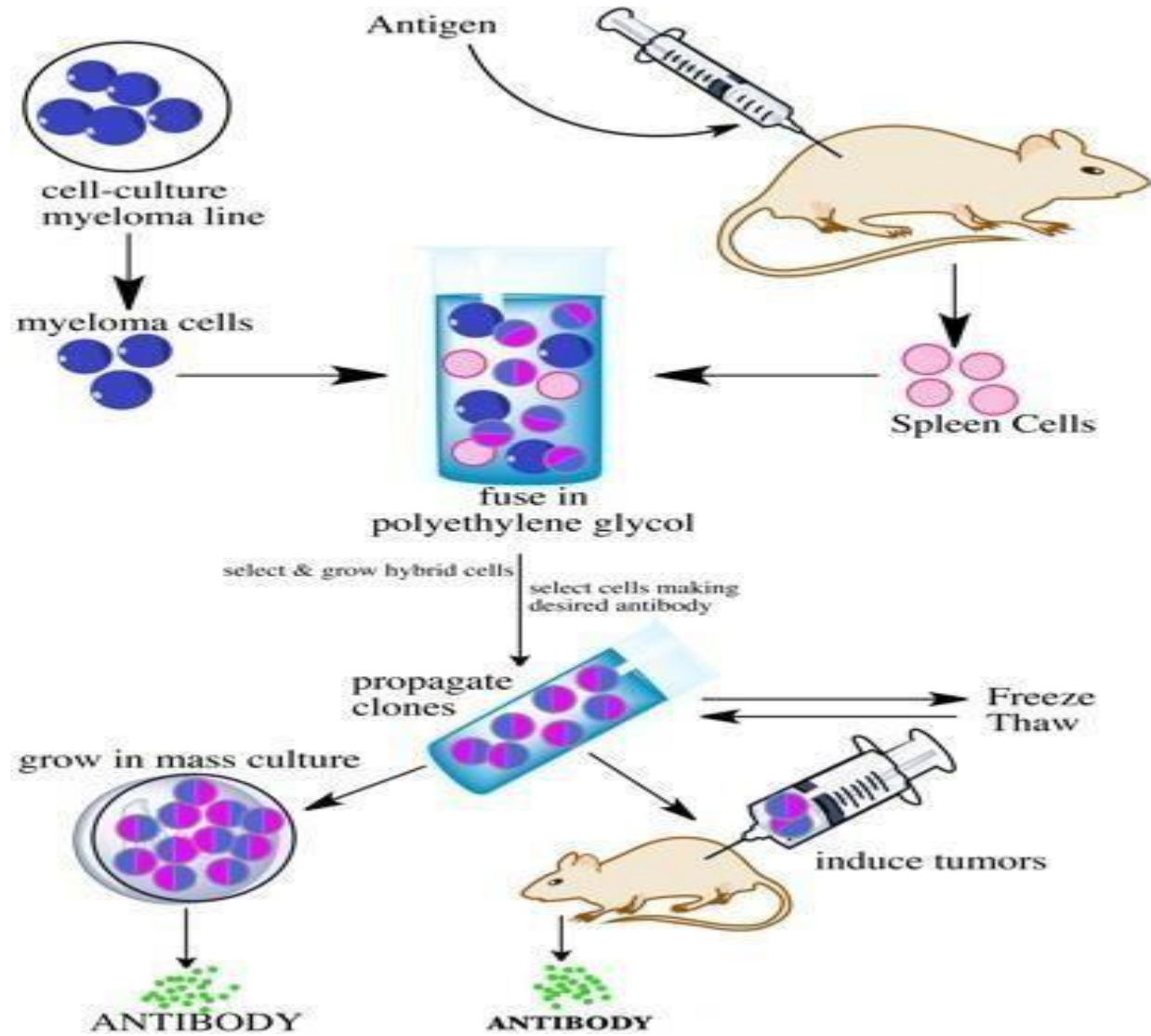

Recombinant antibodies

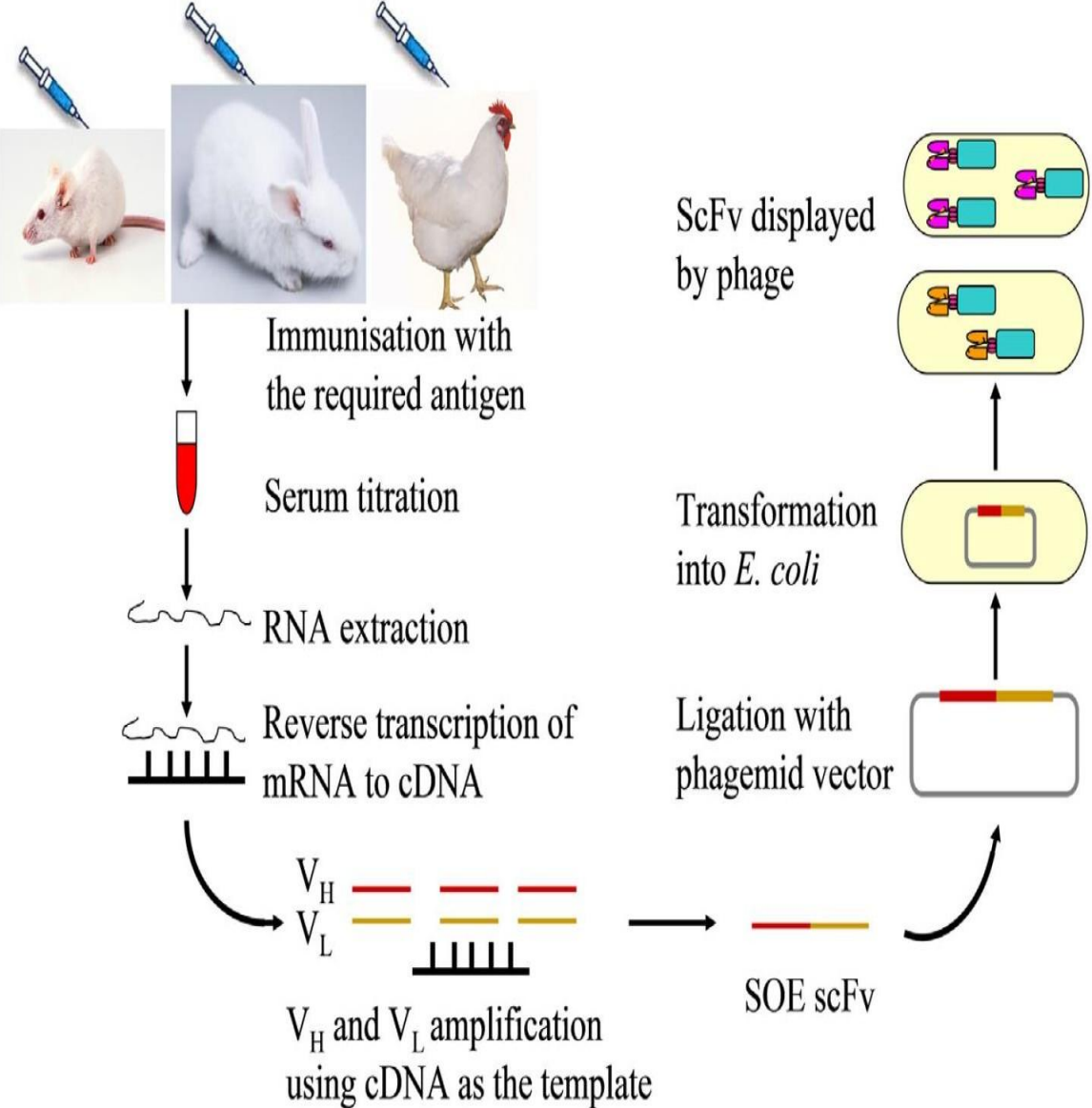

Fig. 1. Illustration of scFv library generation.

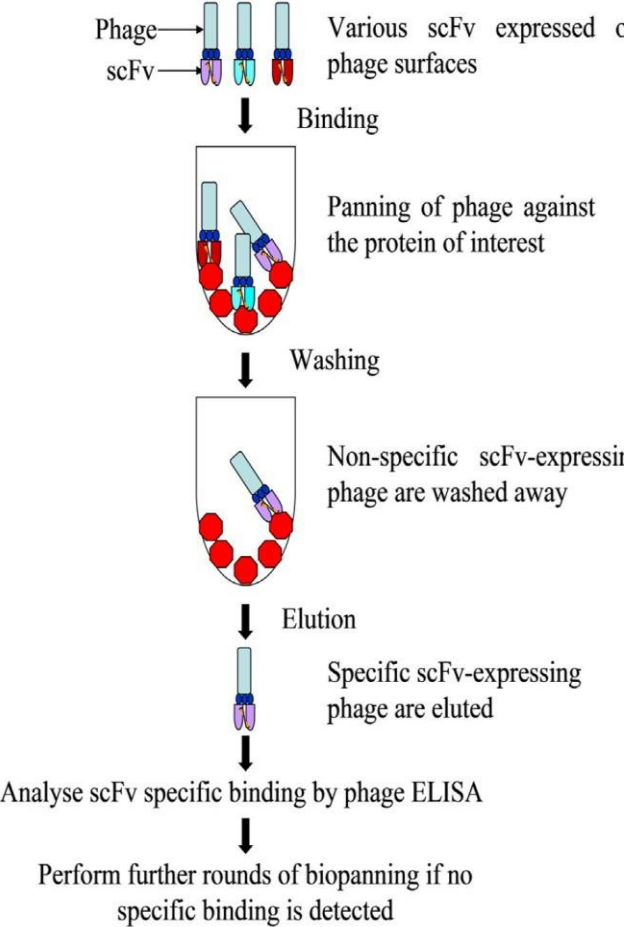
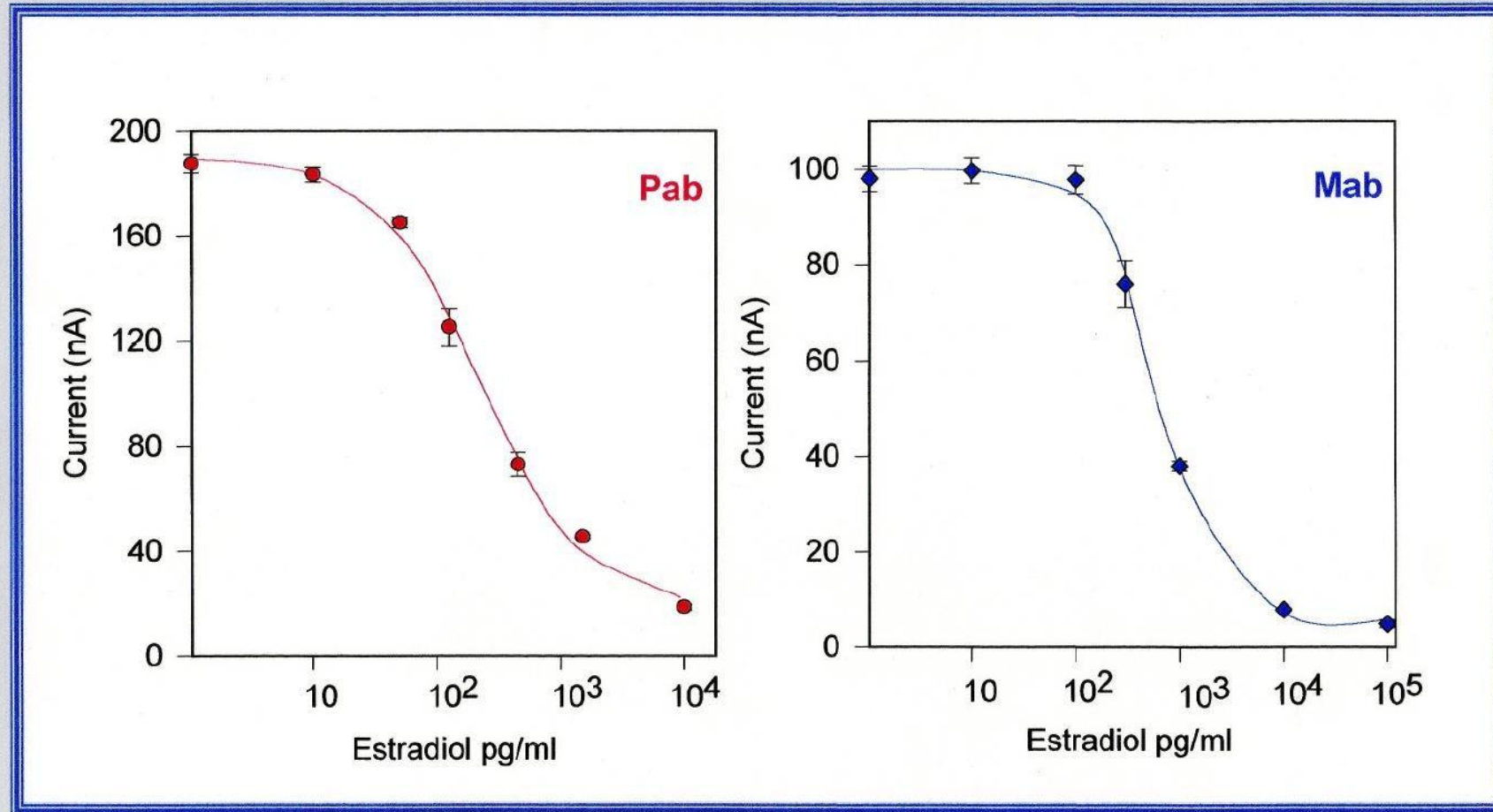

Fig. 2. Illustration of a typical panning cycle.

Enzyme Linked Immuno-Sorbent Assay

ELISA elettrochimico



Pab have wider analytical range sensitivity depends on K_{aff}

ELISA



- **Enzyme-linked immunosorbent assay (ELISA)** is a test that uses antibodies and color change to identify a substance.

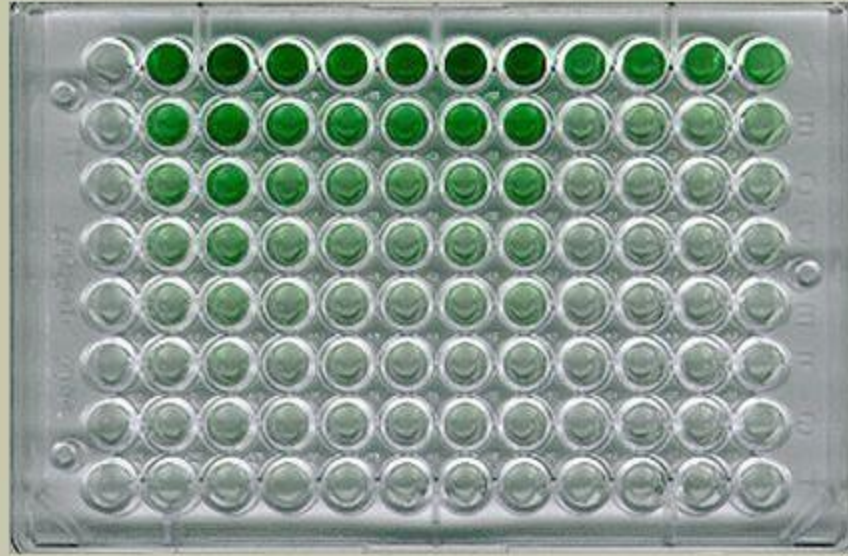

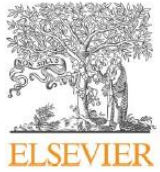

Contents lists available at [ScienceDirect](https://www.sciencedirect.com)

Clinica Chimica Acta

journal homepage: www.elsevier.com/locate/cca



Comparison of test performance of commercial anti-SARS-CoV-2 immunoassays in serum and plasma samples

Verena Haselmann*, Maximilian Kittel, Catharina Gerhards, Margot Thiaucourt, Romy Eichner, Victor Costina, Michael Neumaier

Department of Clinical Chemistry, University Medicine Mannheim, Medical Faculty Mannheim of the Uni



At the end of 2020, over 100 SARS-CoV-2 antibody assays have been CE-marked under EU Directive 98/79/EC . The available test systems can be discriminated into rapid diagnostic tests (RDT), either antigen- or antibody based, enzyme-linked immunosorbent assays (ELISA) and chemiluminescent immunoassays (CLIA).

Journal of Clinical Virology 139 (2021) 104821

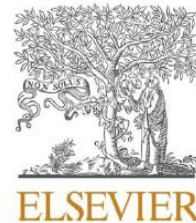

Contents lists available at [ScienceDirect](https://www.sciencedirect.com)

Journal of Clinical Virology

journal homepage: www.elsevier.com/locate/jcv

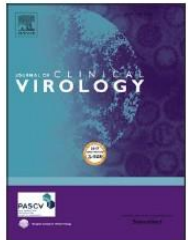

Head-to-head validation of six immunoassays for SARS-CoV-2 in hospitalized patients

Rens Zonneveld^{a,*}, Suzanne Jurriaans^{a,1}, Tom van Gool^a, Jorrit J. Hofstra^a, Thecla A. M. Hekker^a, Pien Defoer^a, Patricia E. Broekhuizen-van Haften^a, Ellen M. Wentink-Bonnema^a, Lynn Boonkamp^b, Charlotte E. Teunissen^b, Annemieke C. Heijboer^c, Frans Martens^c, Godelieve de Bree^d, Michele van Vugt^d, Robin van Houdt^a, Amsterdam UMC COVID-19 Biobank



Chemiluminescent based assay CLIA

The most sensitive!

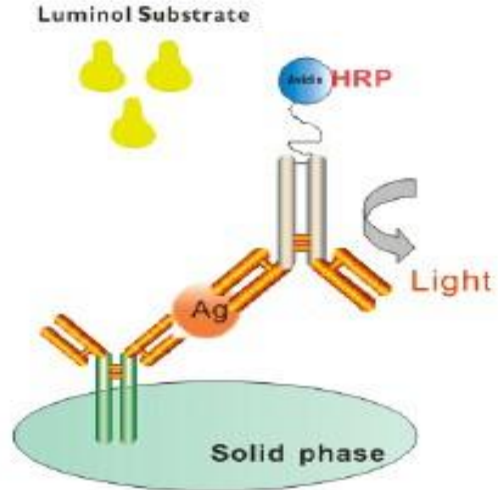

TYPES LUMINESCENCE

| Excitation event | | process |
|------------------|---|----------------------------|
| Chemicals | Luminol Isoluminol acridinium ester | Chemiluminescence |
| Biochemical | Luciferin aequorin | Bioluminescence |
| Electromagnetic | Ruthenium Tris (bipyridly) chelate | Electroluminescence |
| Photons | inorganic phosphors | Photoluminescence |

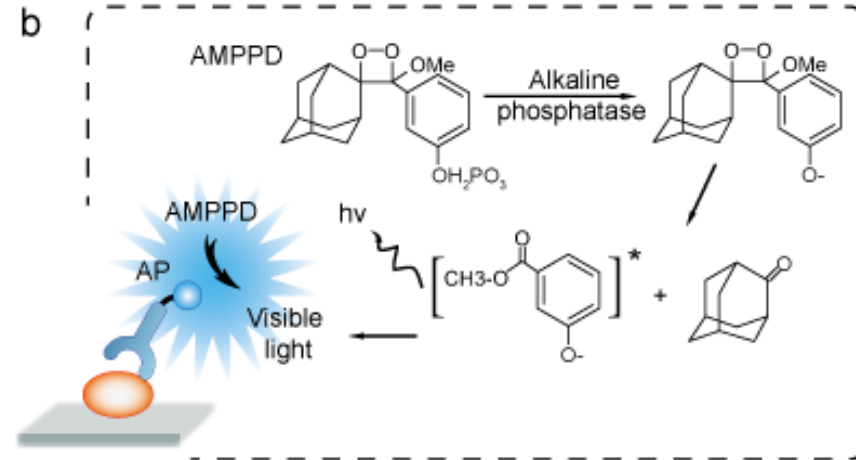
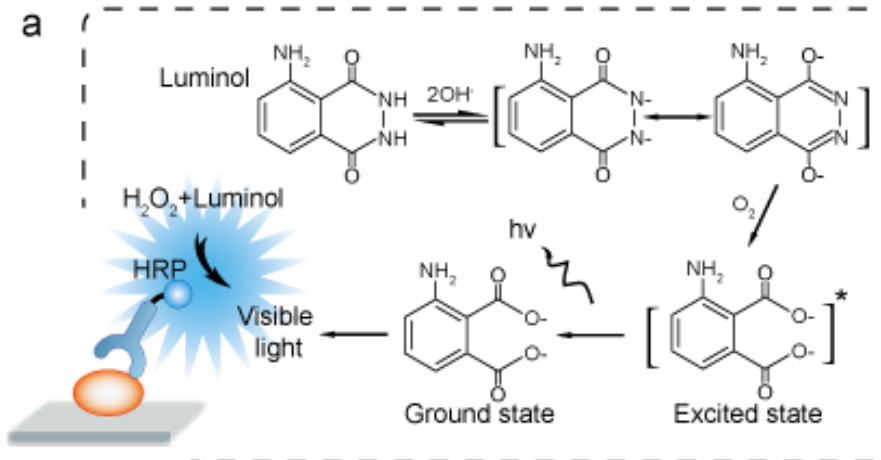

Magnetic Microbeads are very often used for the separation step in immunoassays

A chemiluminescence immunoassay principle in the diagnostic testing of autoantibodies

Main Reaction Components

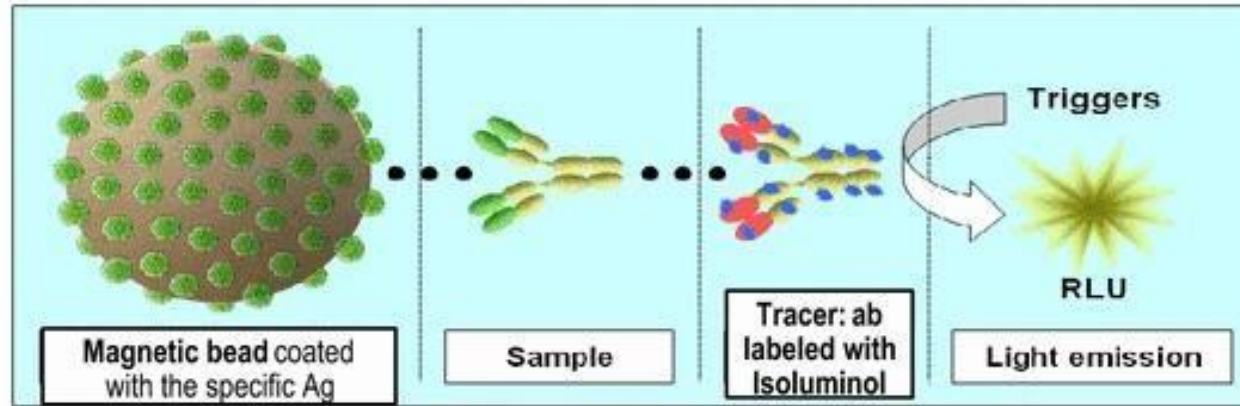

Assay scheme
Chemical reaction of the light emission

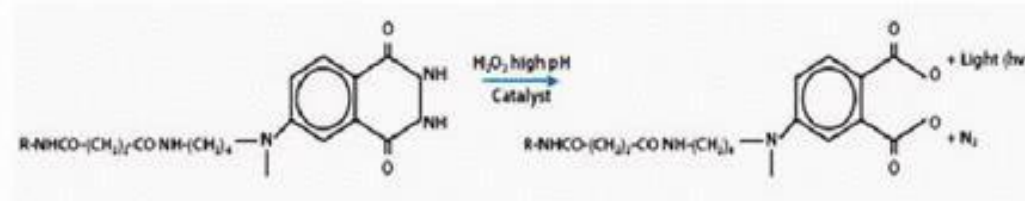
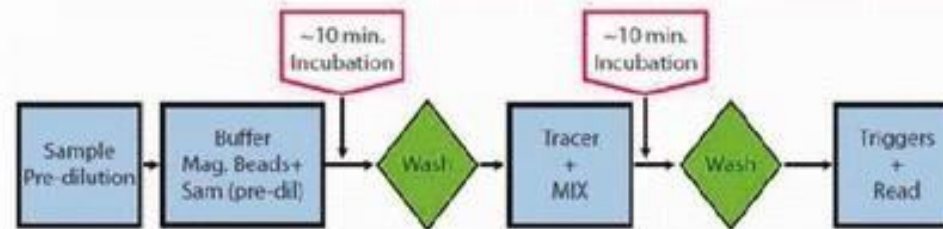

Electrochemical immunosensors (labeled)

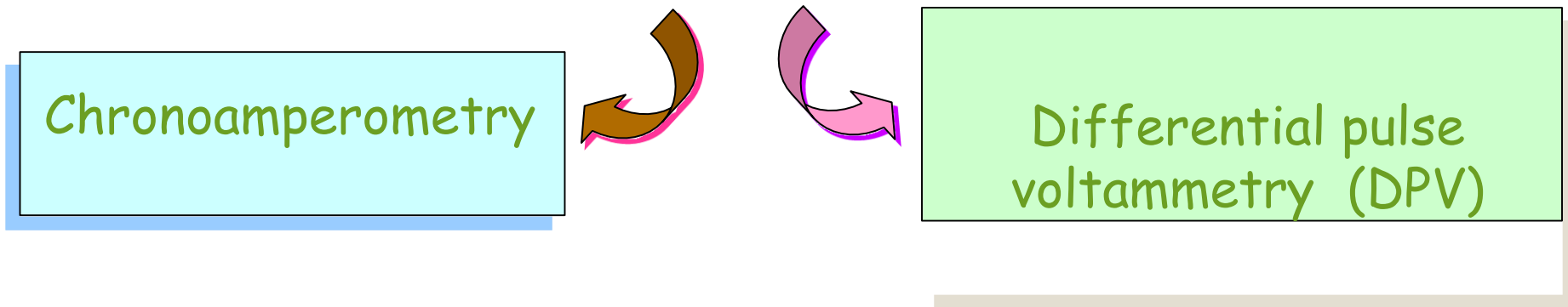

❖ Enzymes and substrates:

Alkaline
phosphatase



1-naphtyl-phosphate

Horseshoe peroxidase



- TetramethylBenzidine + H_2O_2
- $[K_4Fe(CN)_6] + H_2O_2$

electrochemical detection:

chronoamperometry and differential pulse voltammetry (DPV) :

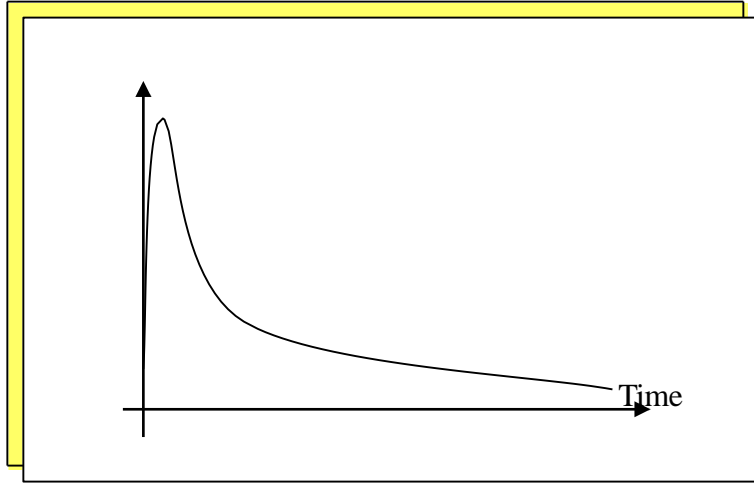

$$\delta_2 = 60 \text{ ms}$$

$$\Delta E_p = 5-100 \text{ mV}$$

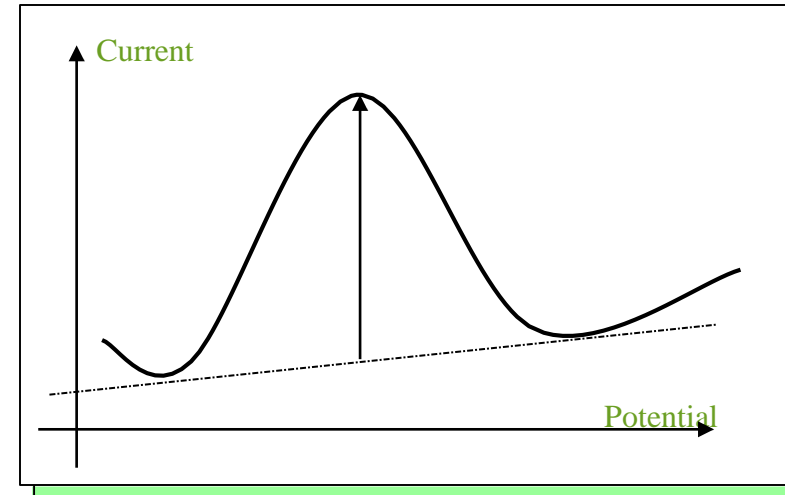
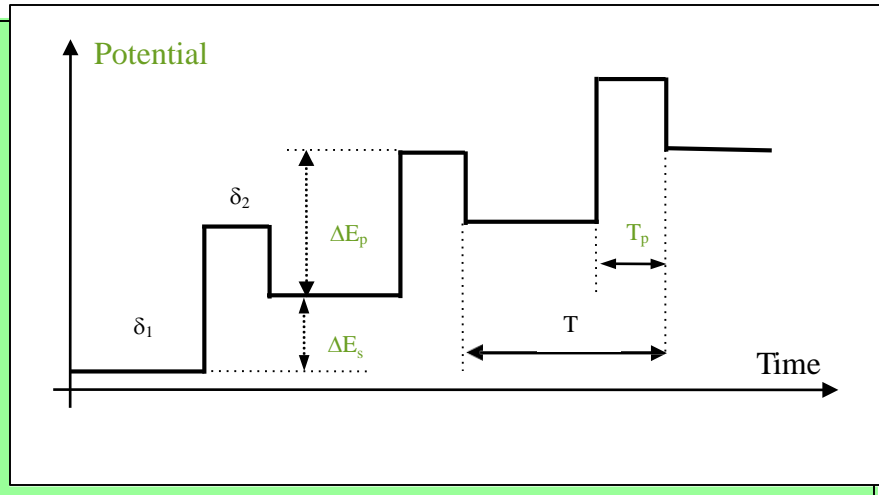

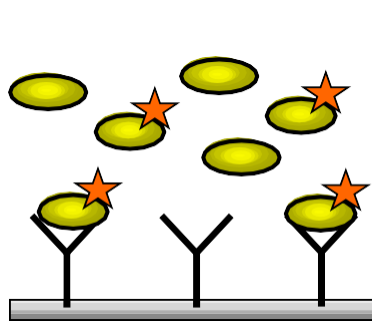

saggio diretto

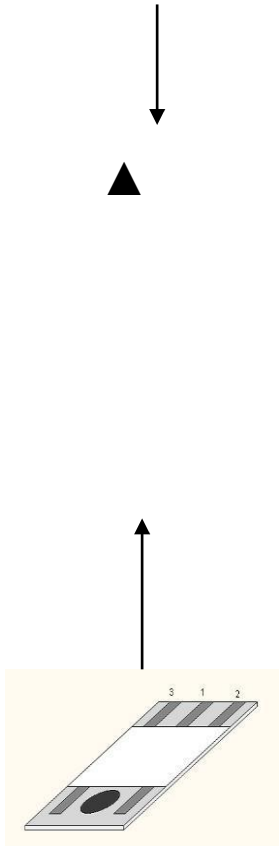

Anti OTA-
Ab

OTA

OTA-ALP

BSA-
OTA

SAb-ALP

Anti OTA-
Ab

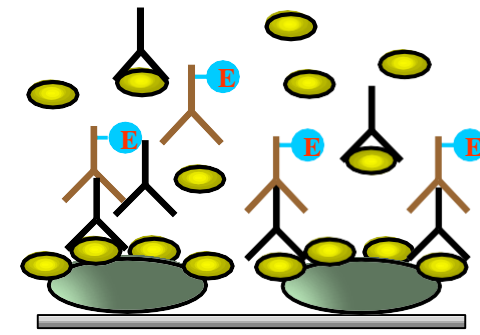

saggio indiretto

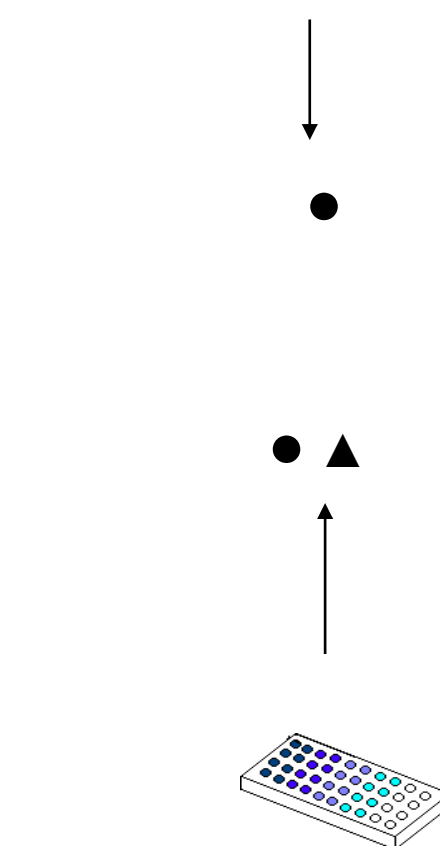

Ocratossina -OTA

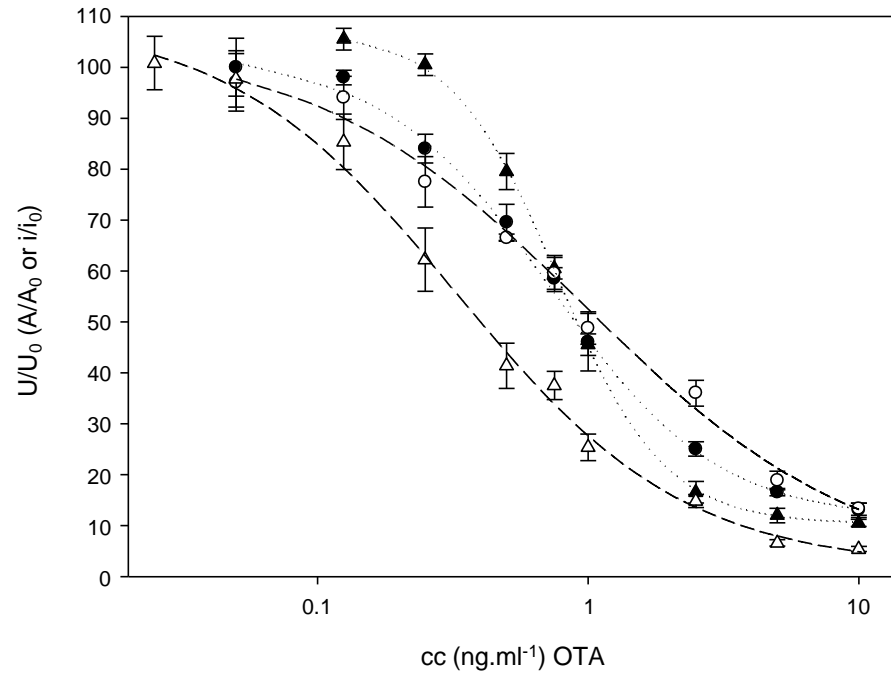

$$f(x) = \{ (a - d) / [1 + (x/c)^b] \} + d$$

| | Competition curve parameters | | | | Linear regression |
|------------------|------------------------------|---------------------------------------|------------------------------------|-----------------------|---|
| | <i>a</i> (A or nA) | <i>b</i> (nA.ng.ml ⁻¹) | <i>c</i> (ng.ml ⁻¹) | <i>d</i> (A or nA) | |
| ic spettr | 1.220 ± 0.053 | 1.40 ± 0.50 | 0.80 ± 0.22 | 0.129 ± 0.077 | $f(x) = 49.3 (\pm 0.8) - 57.5 (\pm 0.1) x$ [$r = 0.991$] |
| ic amp. | 6019 ± 118 | 0.90 ± 0.22 | 0.93 ± 0.10 | 176 ± 30 | $f(x) = 52.5 (\pm 0.4) - 43.7 (\pm 0.5) x$ [$r = 0.994$] |
| dc spettr | 1.392 ± 0.061 | 2.17 ± 0.15 | 0.80 ± 0.14 | 0.132 ± 0.071 | $f(x) = 47.4 (\pm 0.7) - 86.0 (\pm 0.3) x$ [$r = 0.993$] |
| dc amp. | 707 ± 56 | 1.10 ± 0.10 | 0.35 ± 0.04 | 16 ± 13 | $f(x) = 34.9 (\pm 0.6) - 52.2 (\pm 0.9) x$ [$r = 0.992$] |

| Immunoassay | Working Range (ng/ml) | L.O.D. (Blank - 3 σ) (ng/ml) |
|------------------|--------------------------|--|
| ic spettr | 0.20 – 2.5 | 0.150 |
| ic amp. | 0.10 – 7.5 | 0.120 |
| dc spettr | 0.10 – 10 | 0.080 |
| dc amp. | 0.05 – 2.5 | 0.060 |

Immunosensor procedure:

✓Pre-coating: 6 μ l of rabbit anti IgG (4° C overnight)

✓Blocking: 6 μ l of 1 % PVA (polyvinyl alcohol) (30 min)

✓Coating: 6 μ l of anti-OTA Ab (1 h)

✓Competition: 6 μ l of OTA-AP + standard/sample (30 min)

✓Detection: 100 of 5 mg/ml 1-Naphtylphosphate (2 min) + DPV

washings: 150 μ l phosphate buffer pH 7.4

effect of extraction solvent

Activity of an electrode modified with IgG-ALP after 30 min incubation with 1:9 - 9:1 solutions (1:1 in DPBS) acetonitrile:water \rightarrow 95-108%

Sensitivity of the calibration curve \sim 50%

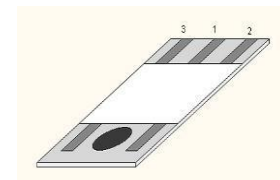

25 g in 100 mL di
ACN:H₂O

Final dilution 1:8

Maximum Residue Limit = 3 ng/g

$I_{50} = 1.6$ ng/g

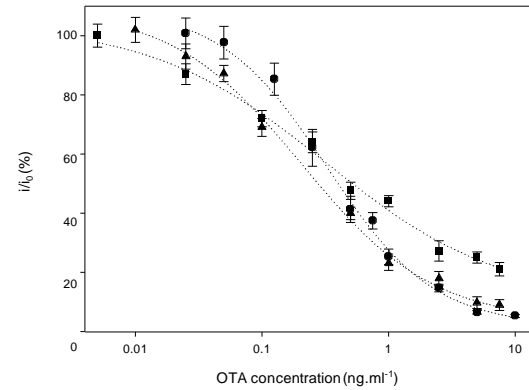

| Parameters | | 0.1 PBS Buffer ● | ACN:H ₂ O (6:4) ▲ | Wheat Extract (blank) ■ |
|-----------------------|---------------------------|-------------------------------|-------------------------------|-------------------------------|
| <i>a</i> | (nA) | 707 (± 56) | 260 (± 12) | 408 (± 72) |
| <i>b</i> | (nA.ng.ml ⁻¹) | 1.1 (± 0.1) | 0.62 (± 0.03) | 0.8 (± 0.1) |
| <i>c</i> (I_{50}) | (ng.ml ⁻¹) | 0.35 (± 0.04) | 0.32 (± 0.02) | 0.20 (± 0.03) |
| <i>d</i> | (nA) | 16 (± 13) | 24 (± 8) | 13 (± 15) |
| w.r. | (ng.ml ⁻¹) | 0.05 – 2.5 | 0.02 – 5.0 | 0.05 – 2.5 |
| L.O.D. | (ng.ml ⁻¹) | 0.06 | 0.015 | 0.05 |
| Lin. | Reg. | 30.9 (± 0.6) – 52.2 (± 0.9) x | 42.3 (± 0.3) – 25.4 (± 0.6) x | 23.5 (± 0.1) – 41.1 (± 0.5) x |

Lateral flow immunoassays

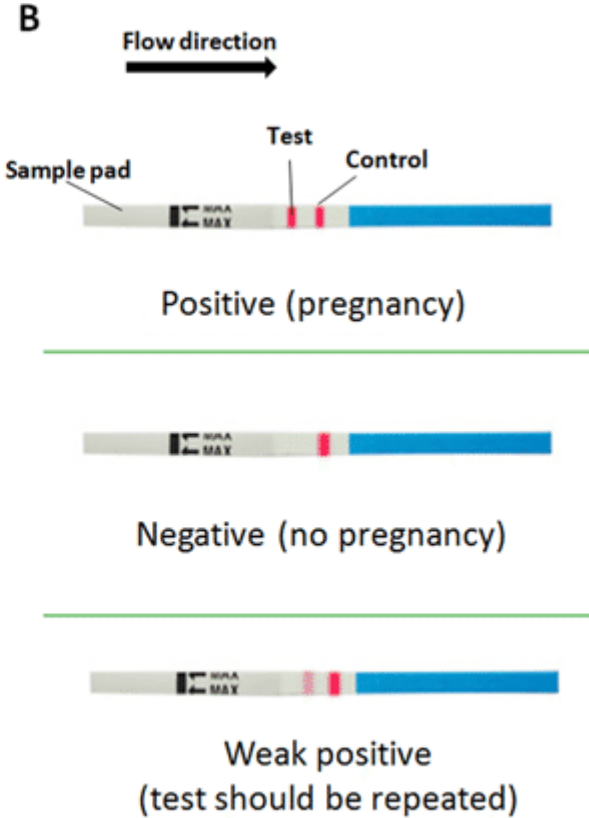
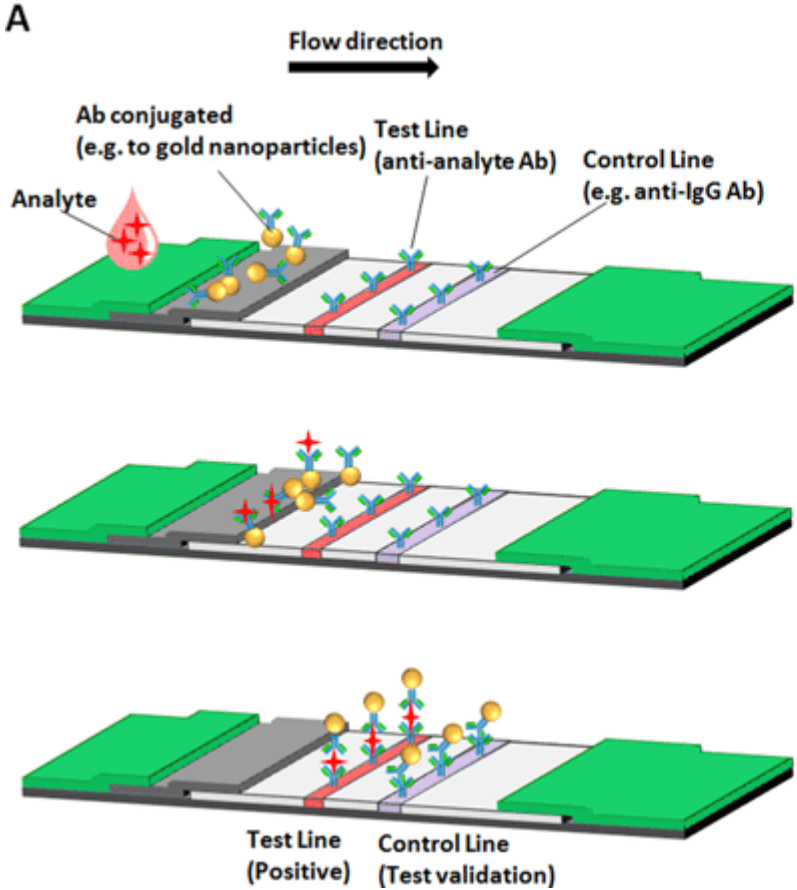
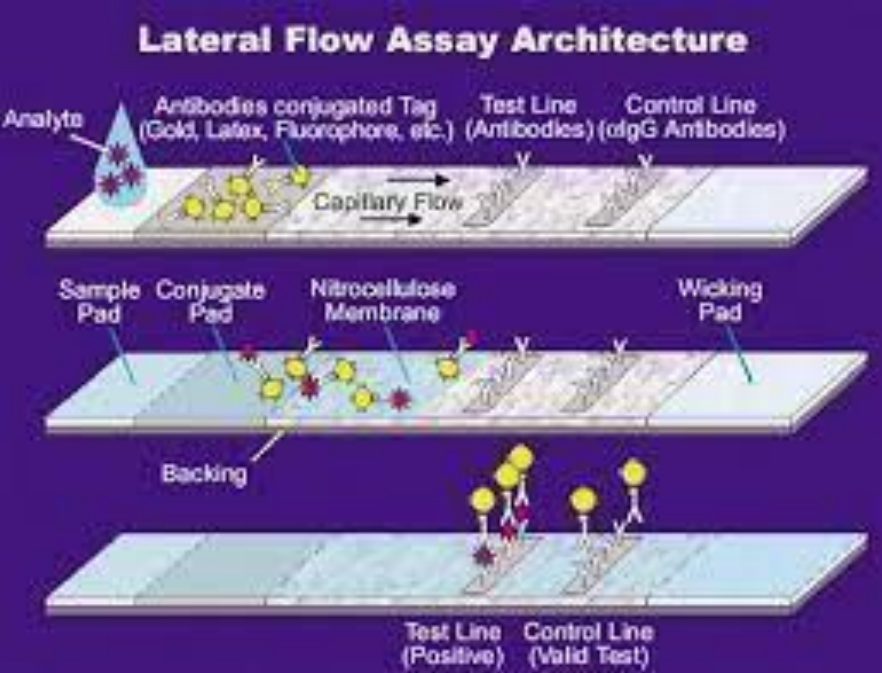

Biacore

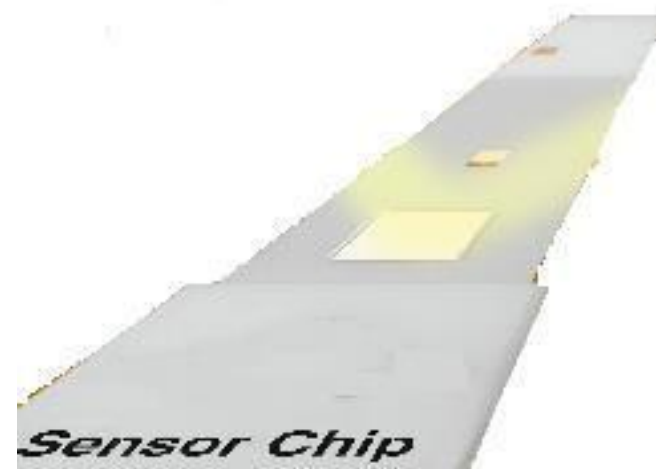
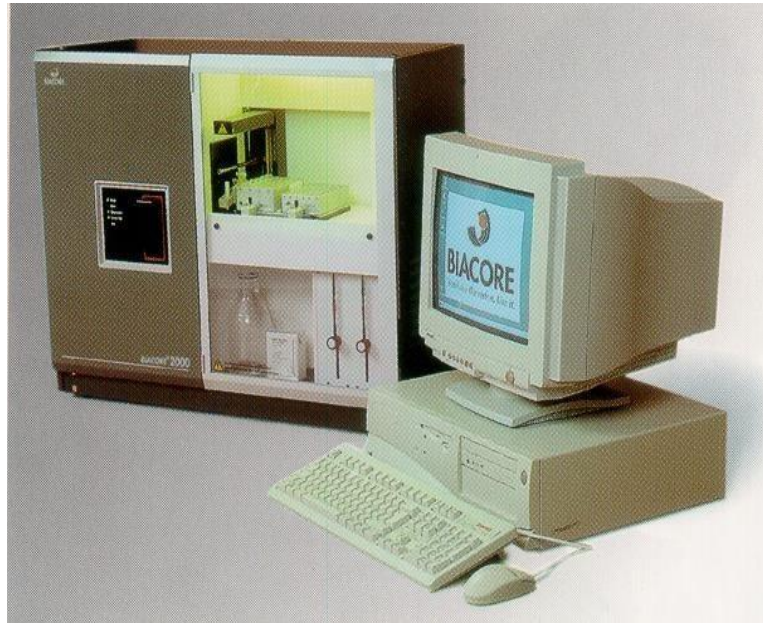

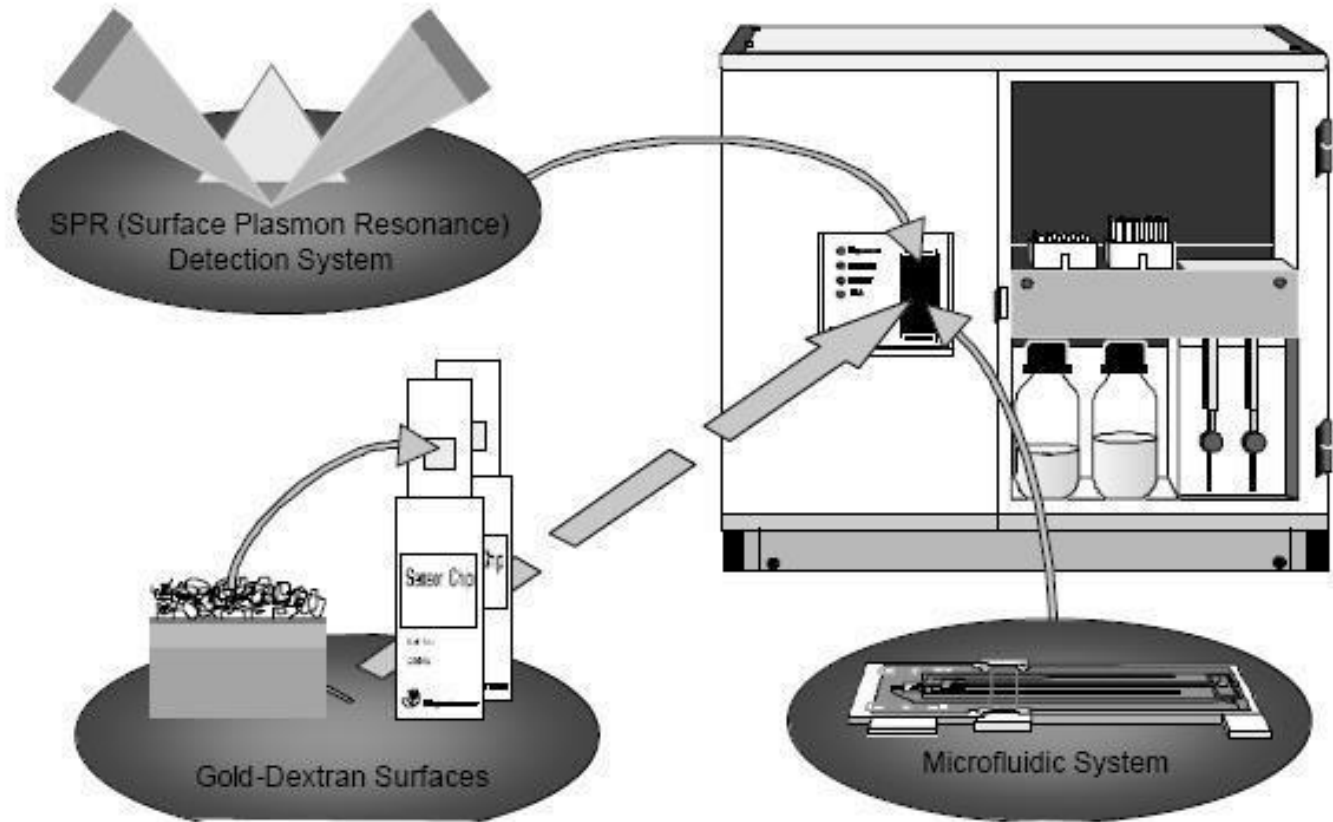

SPR Biosensors label-free!!

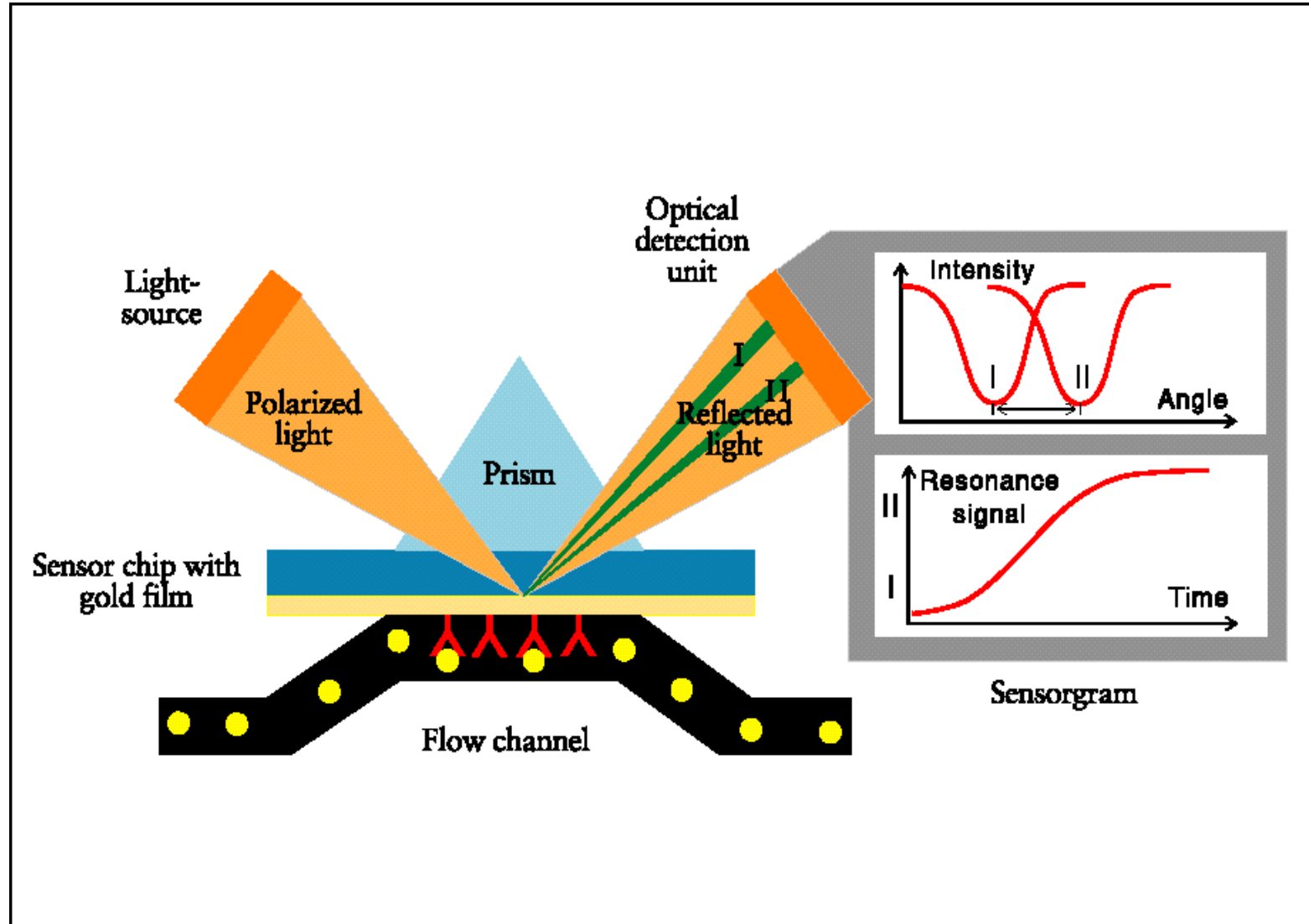

Surface Plasmon Resonance

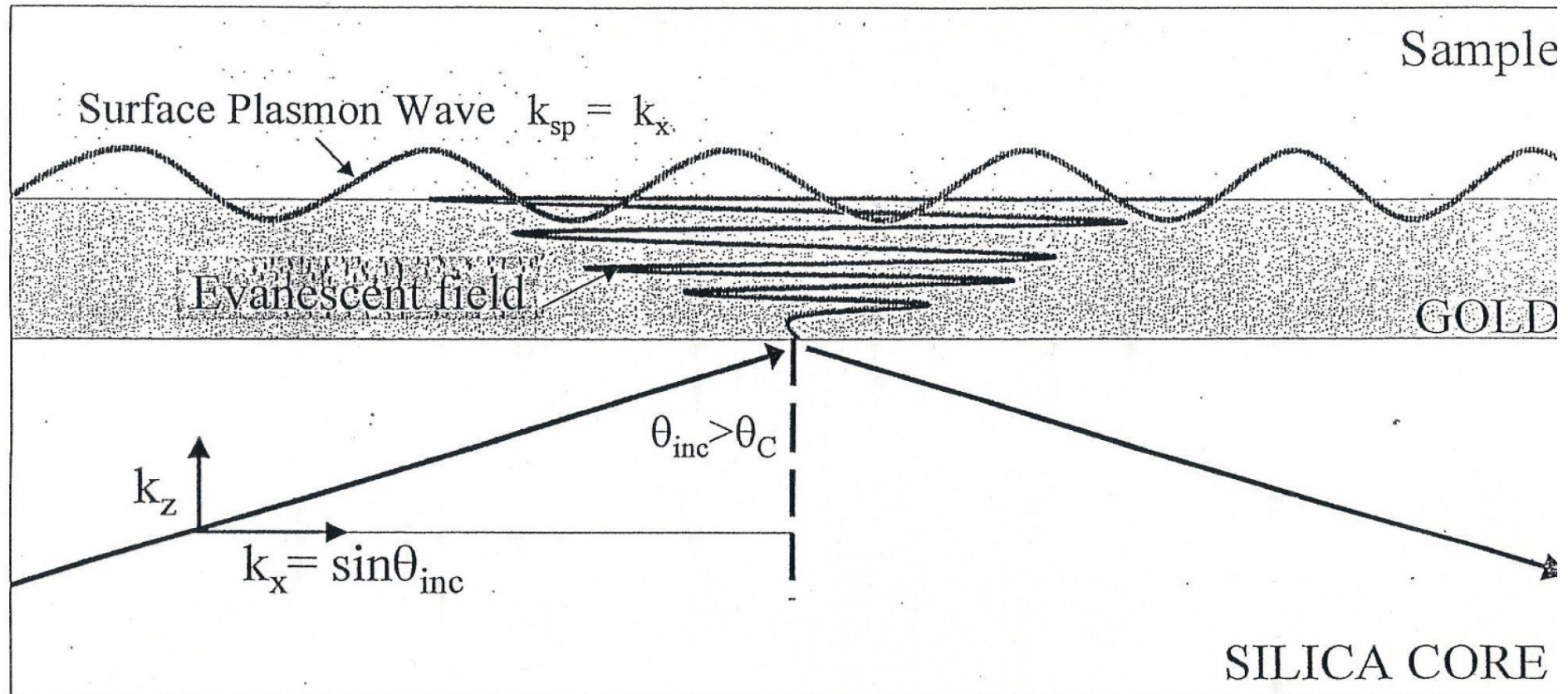

θ_{inc} - angle of incident light

λ_{inc} - wavelength of incident light

n_{glass} - Refractive Index of glass

n_{metal} - Refractive Index of metal

n_{sample} - Refractive index of sample

t_{metal} - Thickness of metal

BIACORE approach

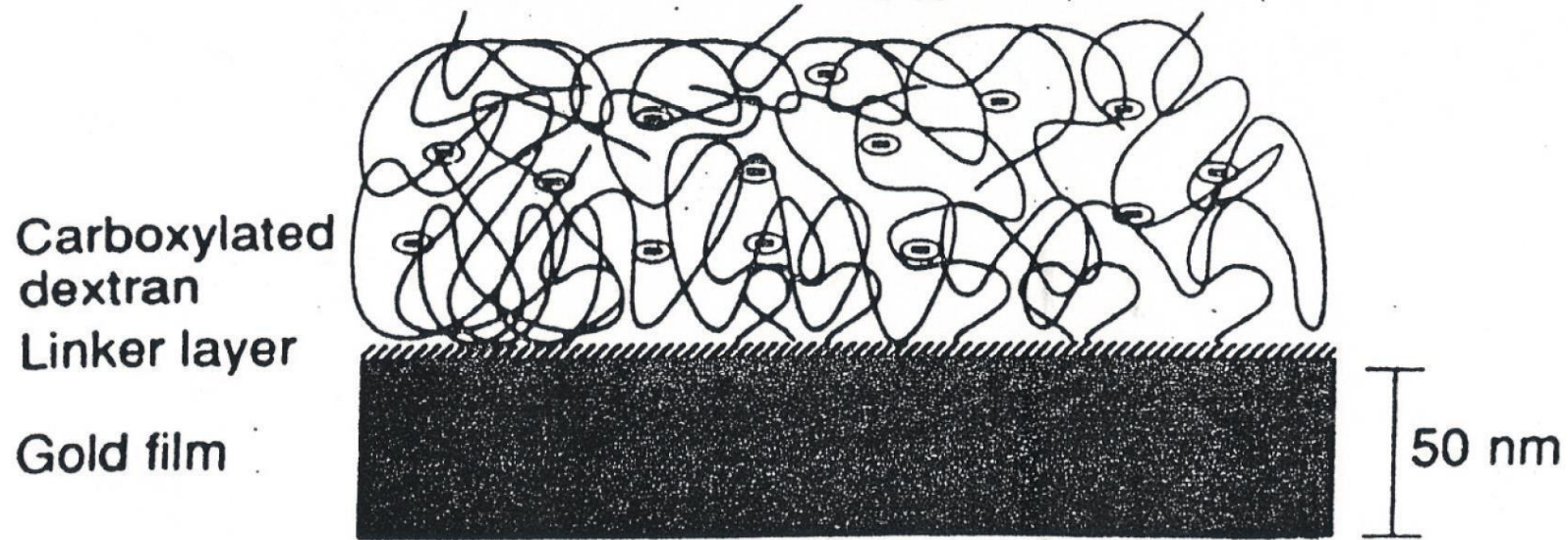

dextran hydrogel

open structure (good accessibility)

no denaturation

- enhancement of the capacity of the interaction layer
- stagnant layer / mass transport flow needed ($\mu\text{l}/\text{min}$)
- negative charge
- regenerable (up to 100 x)

SPR principles

Surface plasmon resonance (SPR) arises when light is reflected under certain conditions from a conducting film at the interface between two media of different refractive index. The media are the sample and the glass of the sensor chip, and the conducting film is a thin layer of gold on the chip surface. SPR causes a reduction in the intensity of reflected light at a specific angle of reflection. This angle varies with the refractive index close to the surface on the side opposite from the reflected light.

When molecules in the sample bind to the sensor surface, the concentration and therefore the refractive index at the surface changes and an SPR response is detected. Plotting the response against time during the course of an interaction provides a quantitative measure of the progress of the interaction. This plot is called a sensorgram.

What Biacore actually measures is the angle of minimum reflected light intensity. The light is not absorbed by the sample: instead the light energy is dissipated through SPR in the gold film. Thus the light used to detect interaction processes never enters the sample.

SPR response values are expressed in resonance units (RU). One RU represents a change of 0.0001° in the angle of the intensity minimum. For most proteins, this is roughly equivalent to a change in concentration of about 1 pg/mm^2 on the sensor surface. The exact conversion factor between RU and surface concentration depends on properties of the sensor surface and the nature of the molecule responsible for the concentration change.

Sensorgram

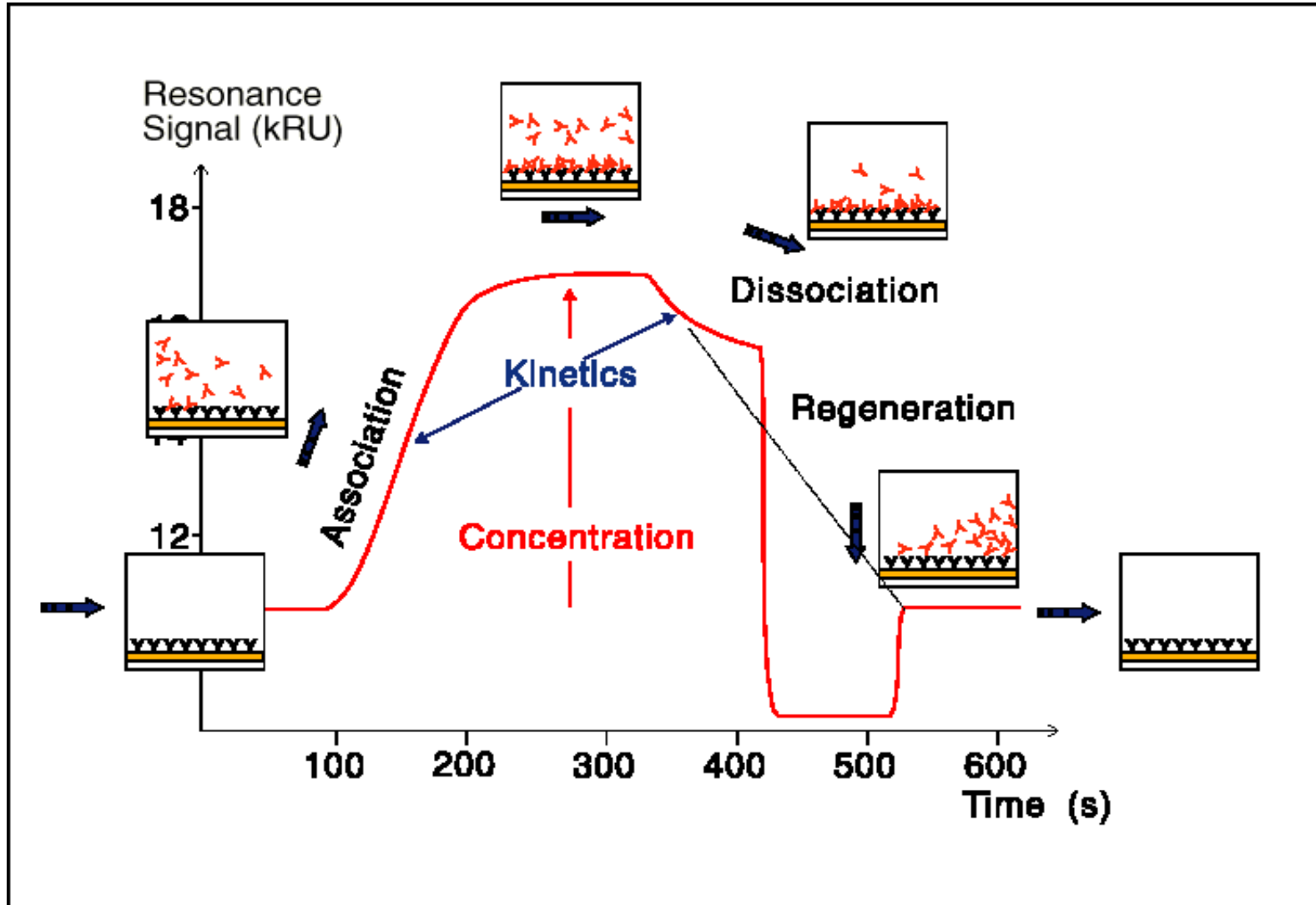

Immobilisation of organic molecules on gold

Self Assembled Monolayers (SAM)

Disulphides (R-S-S-R)
Sulphides (R-S-R)
Thiols (R-SH)

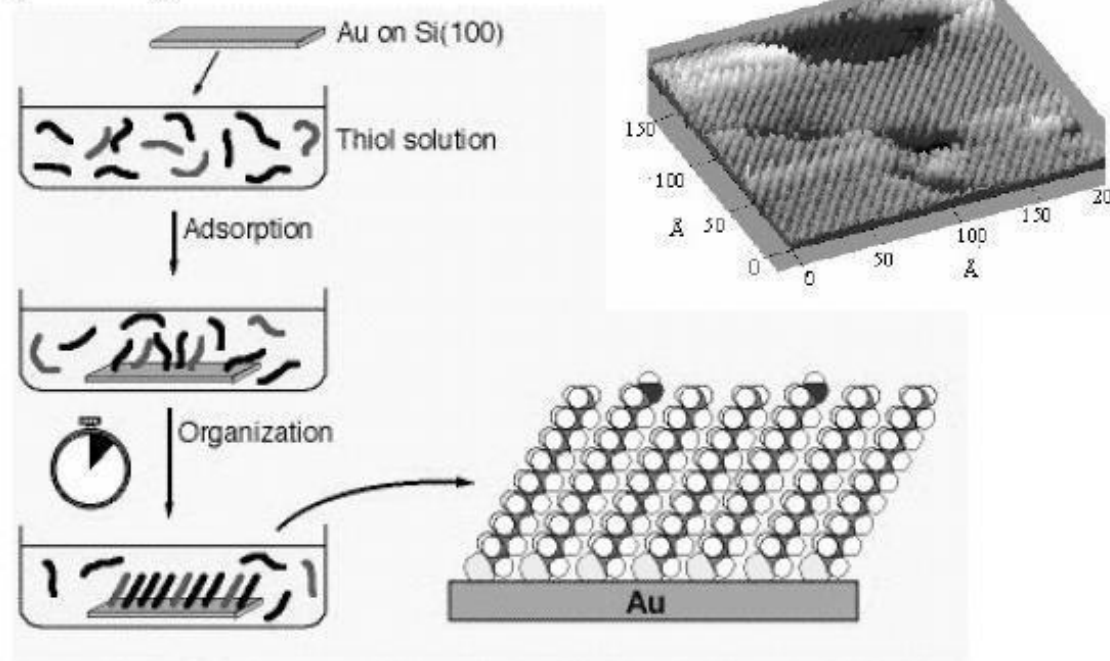

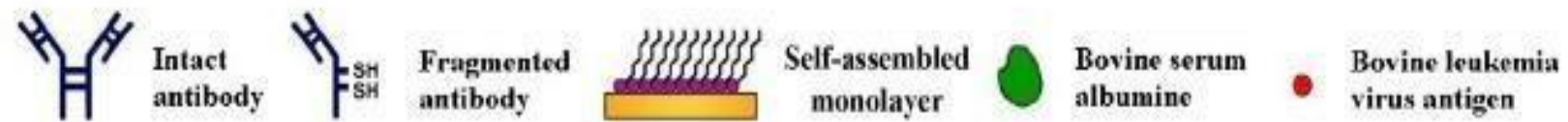
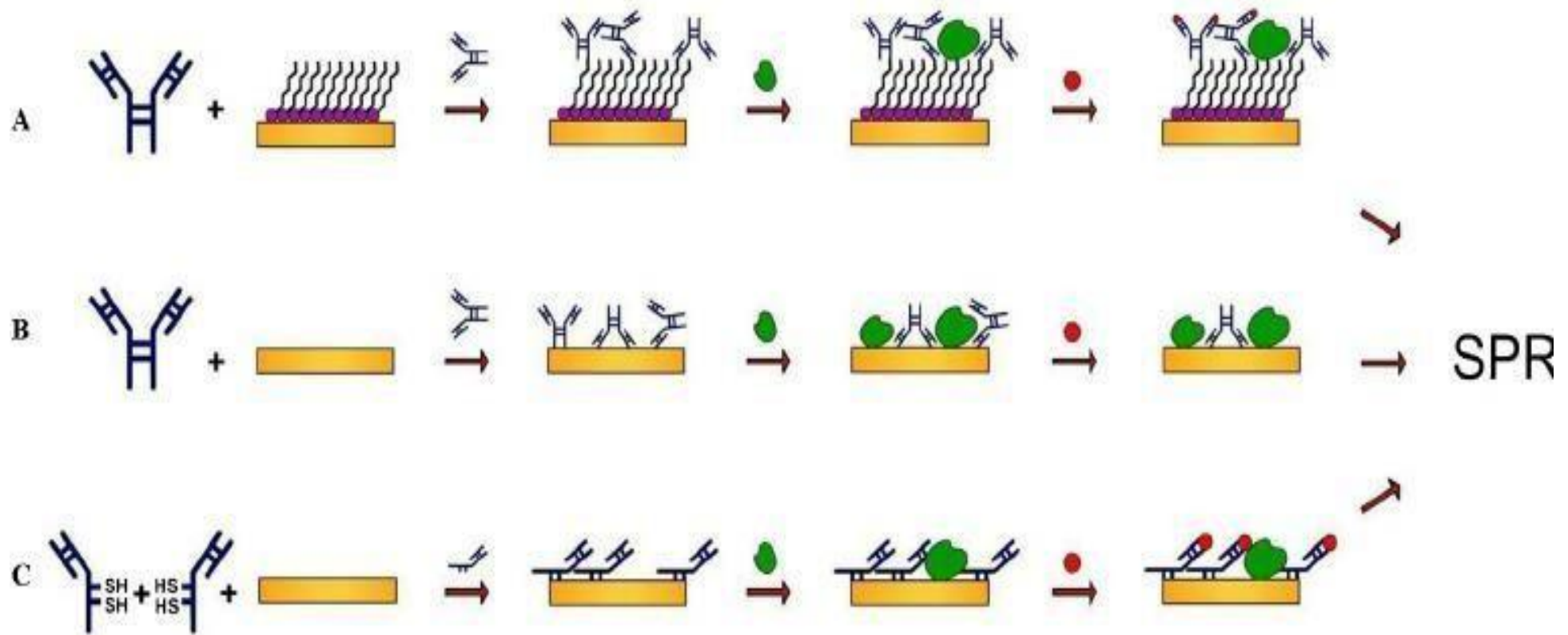

Spr sensors and microfluidics

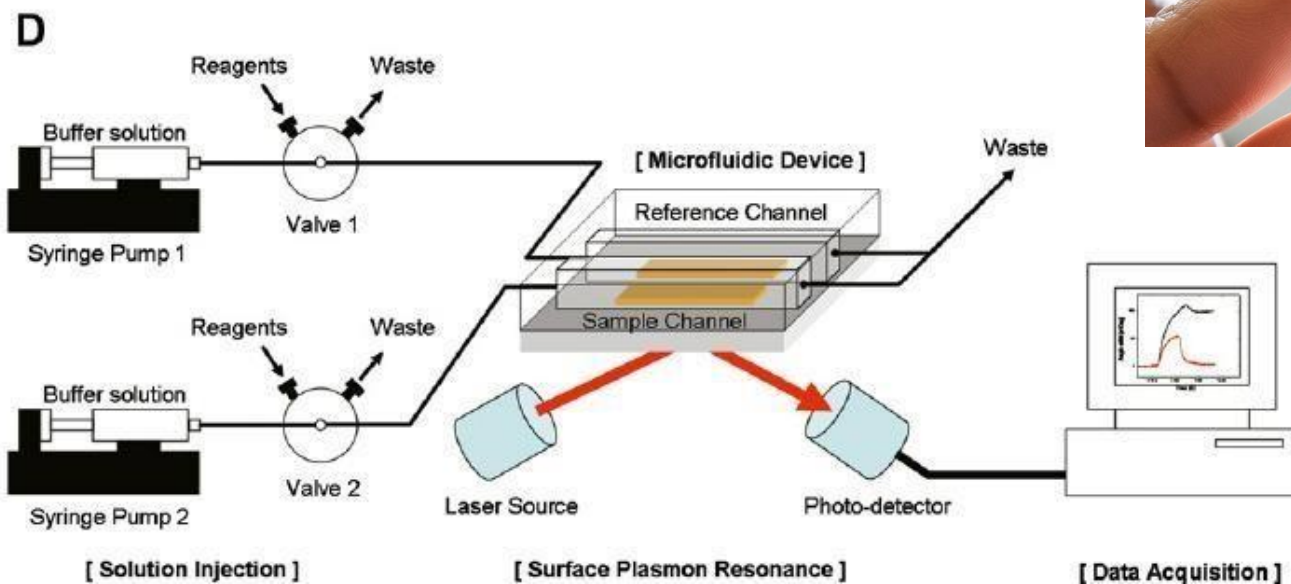
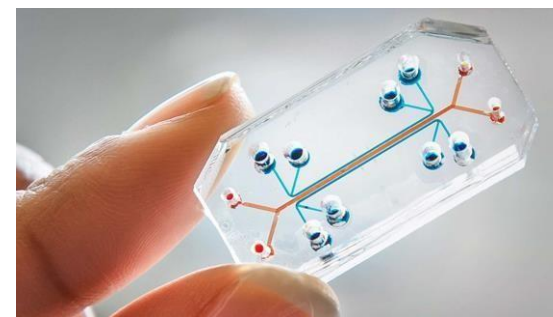
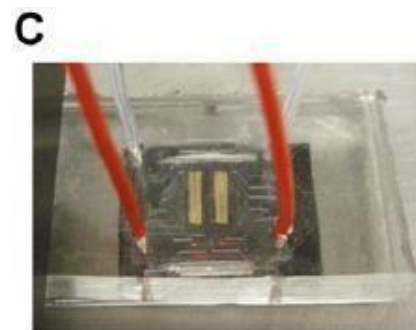
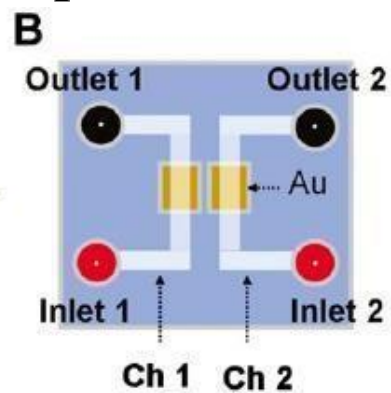
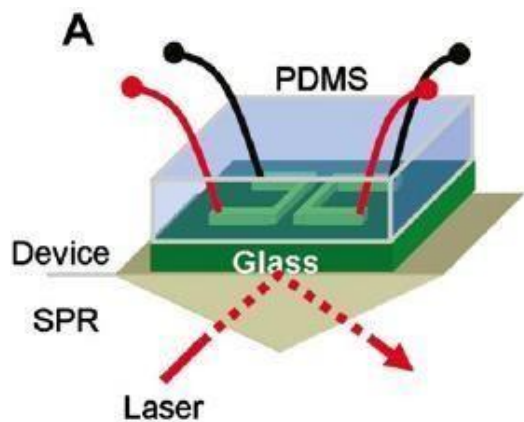

BIO(immuno)FETs label-free!

An **ion-sensitive field-effect transistor (ISFET)** is a [field-effect transistor](#) used for measuring ion concentrations in solution; when the ion concentration (such as H^+ , see [pH scale](#)) changes, the current through the [transistor](#) will change accordingly. Here, the solution is used as the gate electrode. A voltage between substrate and [oxide](#) surfaces arises due to an [ion sheath](#). It is a special type of [MOSFET](#) (metal-oxide-semiconductor field-effect transistor),^[1] and shares the same basic structure, but with the [metal gate](#) replaced by an ion-sensitive [membrane](#), [electrolyte](#) solution and [reference electrode](#).^[2] Invented in 1970, the ISFET was the first [biosensor FET](#) (BioFET) source wikipedia

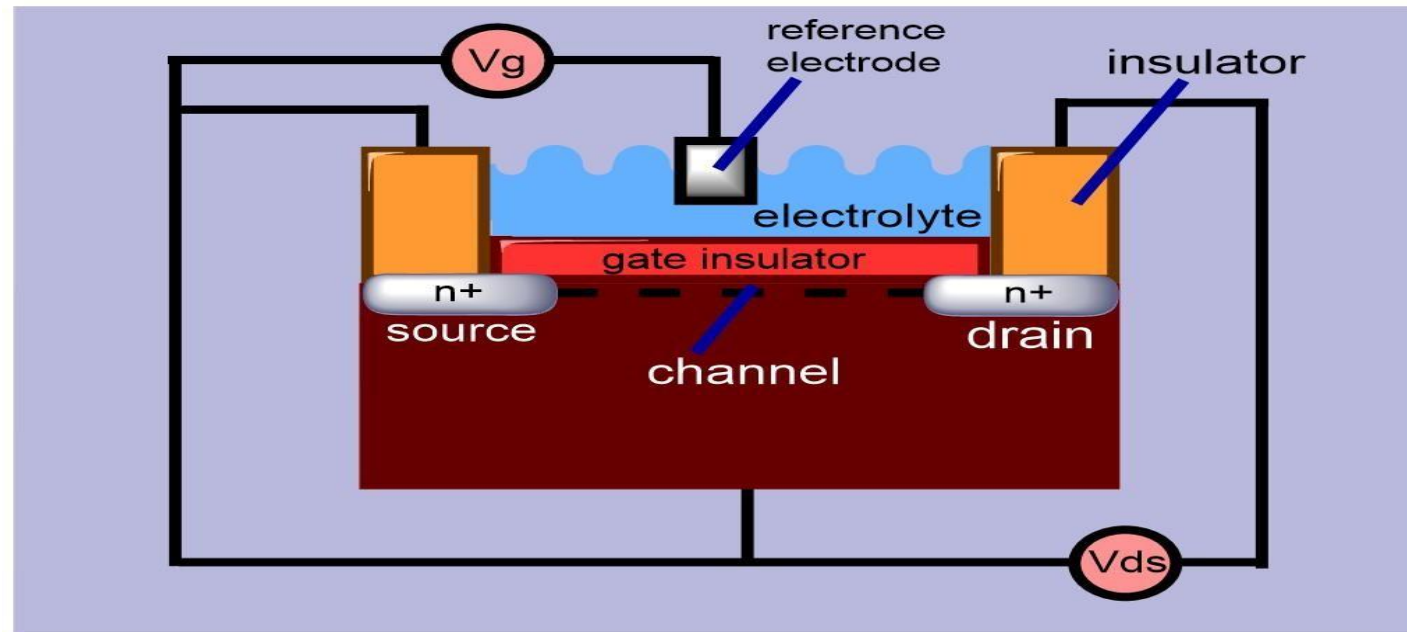

Bio-FETs couple a [transistor](#) device with a bio-sensitive layer that can specifically detect bio-molecules such as nucleic acids and proteins. A Bio-FET system consists of a semiconducting [field-effect transistor](#) that acts as a [transducer](#) separated by an insulator layer (e.g. [SiO₂](#)) from the biological recognition element (e.g. receptors or probe molecules) which are selective to the target molecule called analyte.^[8] Once the analyte binds to the recognition element, the charge distribution at the surface changes with a corresponding change in the electrostatic surface potential of the semiconductor. This change in the surface potential of the semiconductor acts like a gate voltage would in a traditional [MOSFET](#), i.e. changing the amount of current that can flow between the source and drain electrodes.^[9] This change in current (or [conductance](#)) can be measured, thus the binding of the analyte can be detected. The precise relationship between the current and analyte concentration depends upon the [region of transistor operation](#) (source Wikipedia)

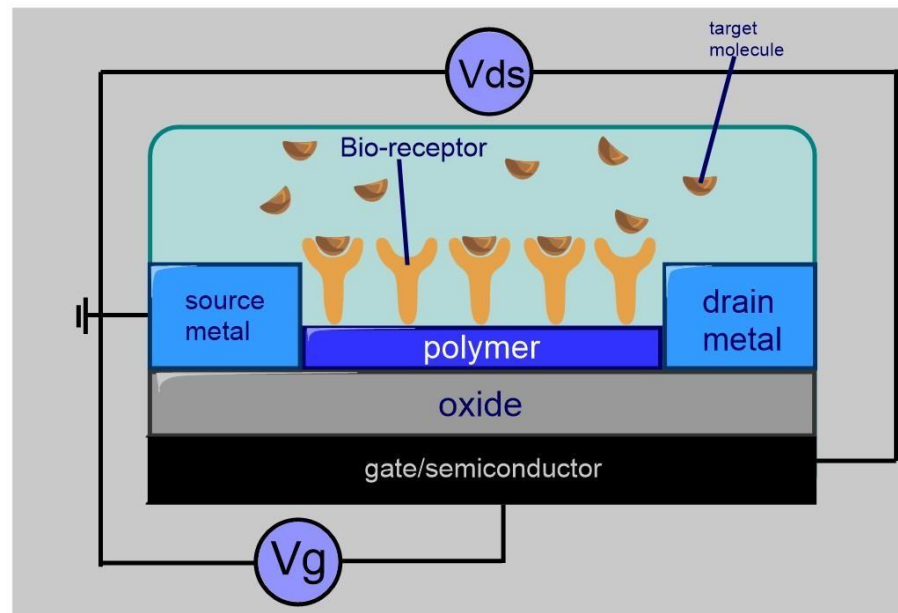

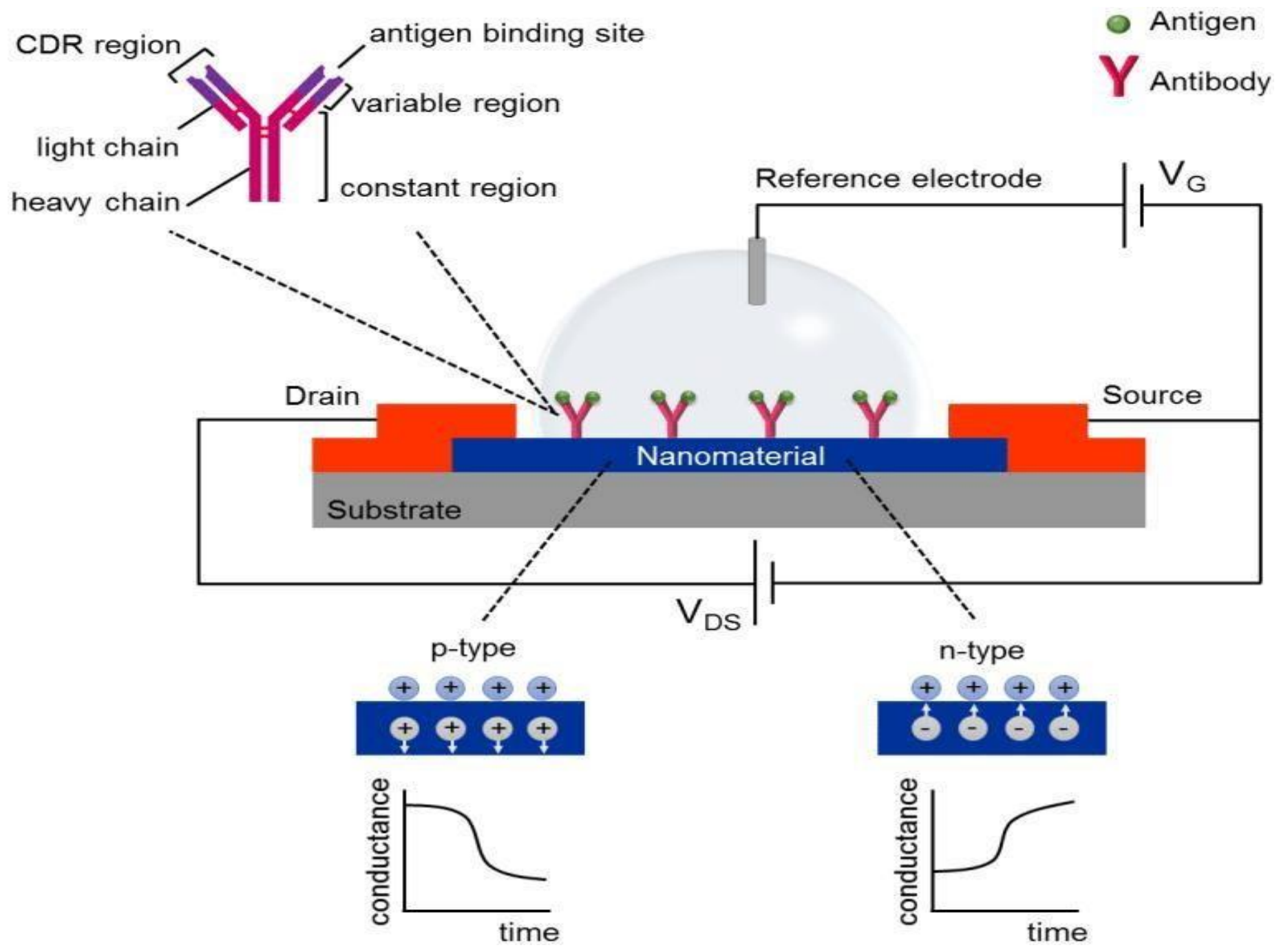

Piezoelectric Biosensors label-free!

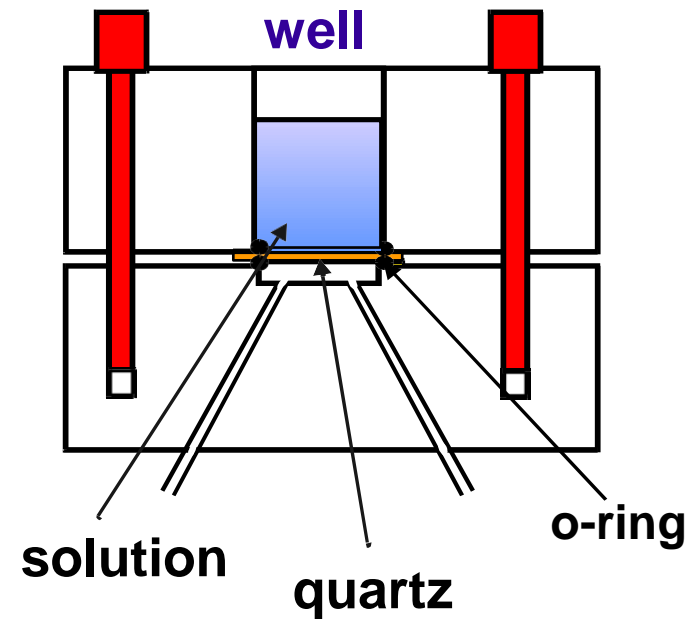
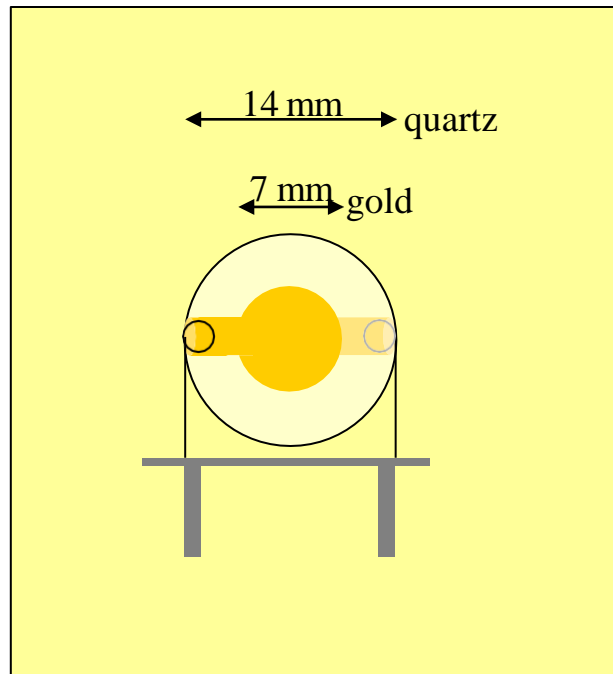
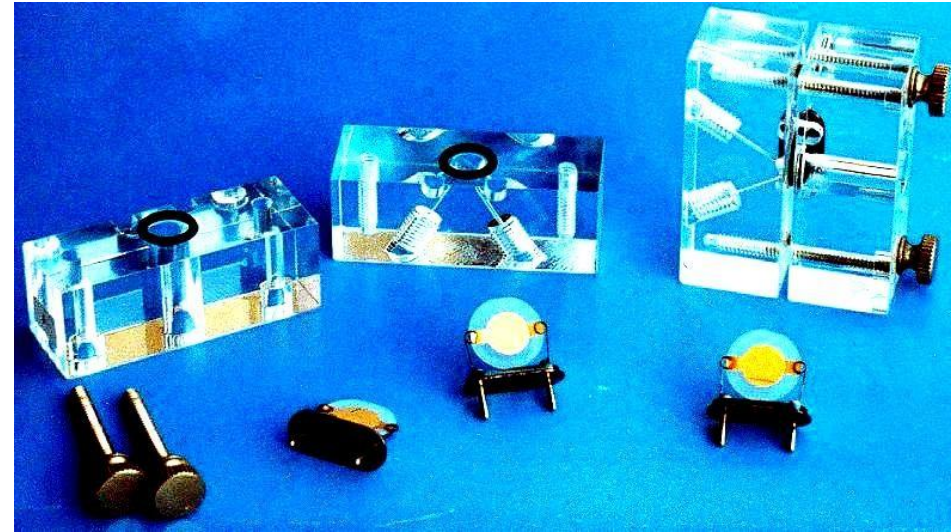
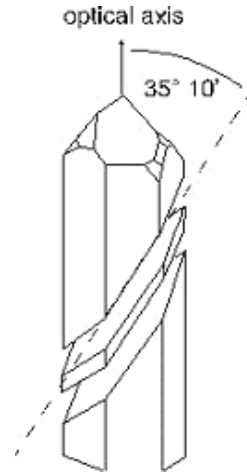
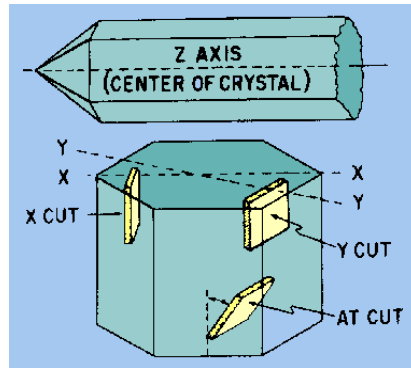

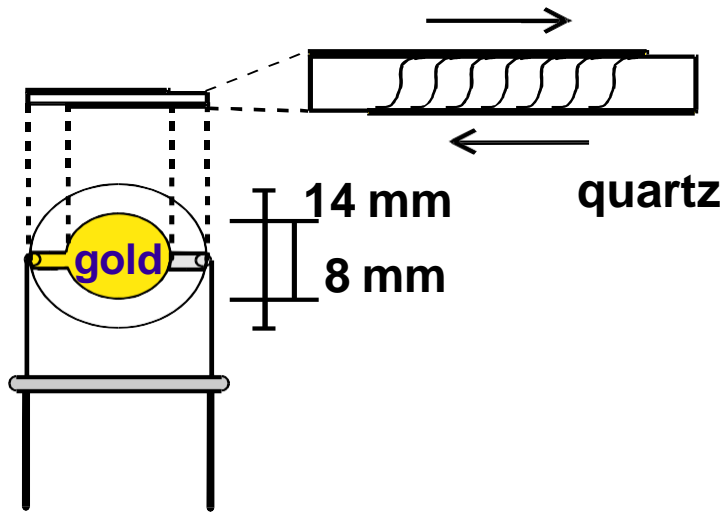

The standard QCM measures the mass of a material deposited on a quartz crystal surface as a linear function of a change in the oscillating crystal resonant frequency

The mass-loading frequency effects of the transducer are based upon Sauerbrey's equation

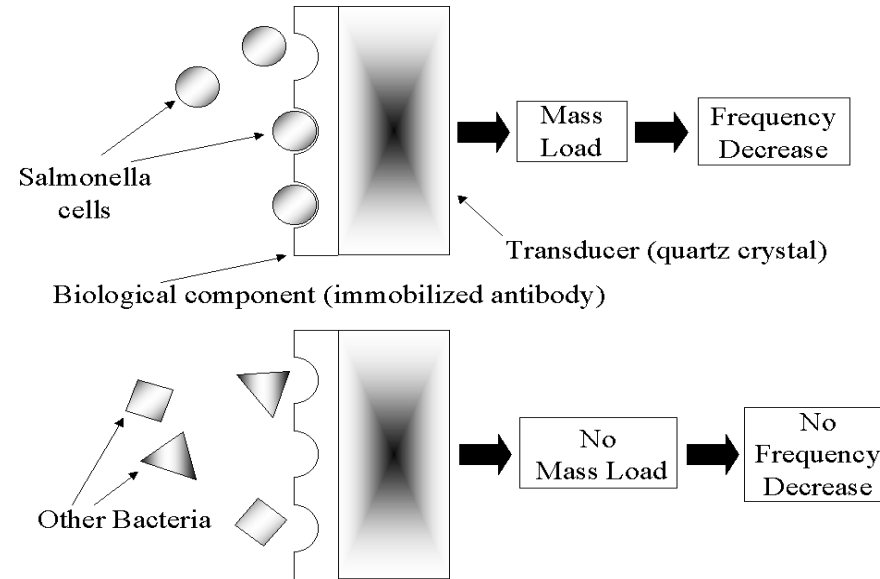

QCM-Mass

$$\Delta F = (-2.3 \times 10^{-6}) F^2 \Delta M / A$$

ΔF (Hz) = frequency shift of the coated crystal

F (Hz) = resonance frequency of the crystal

ΔM (g) = increase in mass loading

A (cm²) = area of the coated crystal



Carboxymethyl chitosan assembled piezoelectric biosensor for rapid and label-free quantification of immunoglobulin Y

Hao Li^a, Min Long^a, Huiyu Su^a, Lei Tan^b, Xiaowen Shi^a, Yumin Du^a, Yan Luo^{b,*}, Hongbing Deng^{a,c,*}

^a Hubei Key Laboratory of Biomass Resource Chemistry and Environmental Biotechnology, Hubei International Scientific and Technological Cooperation Base of Sustainable Resource and Energy, School of Resource and Environmental Science, Wuhan University, Wuhan 430079, China

^b Shenzhen Institute of Quality & Safety Inspection and Research, Shenzhen 518000, China

^c Shenzhen Research Institute, Wuhan University, Shenzhen 518063, China

ARTICLE INFO

ABSTRACT

