

# Untargeted analysis E-noses and FTIR

# Electronic nose (E-nose)

- Electronic noses are engineered to mimic the mammalian olfactory system
- Instrument designed to allow detection and classification of aroma mixtures
- Refers to the capability of reproducing human senses using sensor arrays and pattern recognition system



✓ *cosmetic industry control*



✓ *environmental monitoring for air quality control*



✓ *food quality and safety control*





An electronic nose can now diagnose cancerous tumors. A new research have designed an electronic nose to help diagnose malignant mesothelioma early on. This nose can detect the presence of the tumor with a breath test. Malignant mesothelioma is an uncommon, usually fatal, cancerous tumour of the lining of the lung and chest cavity or lining of the abdomen (peritoneum) caused by long-term asbestos exposure. The device was designed to distinguish between benign and malignant disease and to detect the disease early. "If you catch it earlier, your chances of actually giving people the right treatment to stop it spreading are actually better," said team leader, Deborah Yates. "We tried to exclude the other asbestos diseases because it's very important from a patient's point of view that you don't pick up something that is a benign asbestos disease, so that you don't diagnose them with something that's not actually a problem," added Yates.

<https://www.thehealthsite.com/news/electronic-nose-helps-locate-deadly-tumour/>

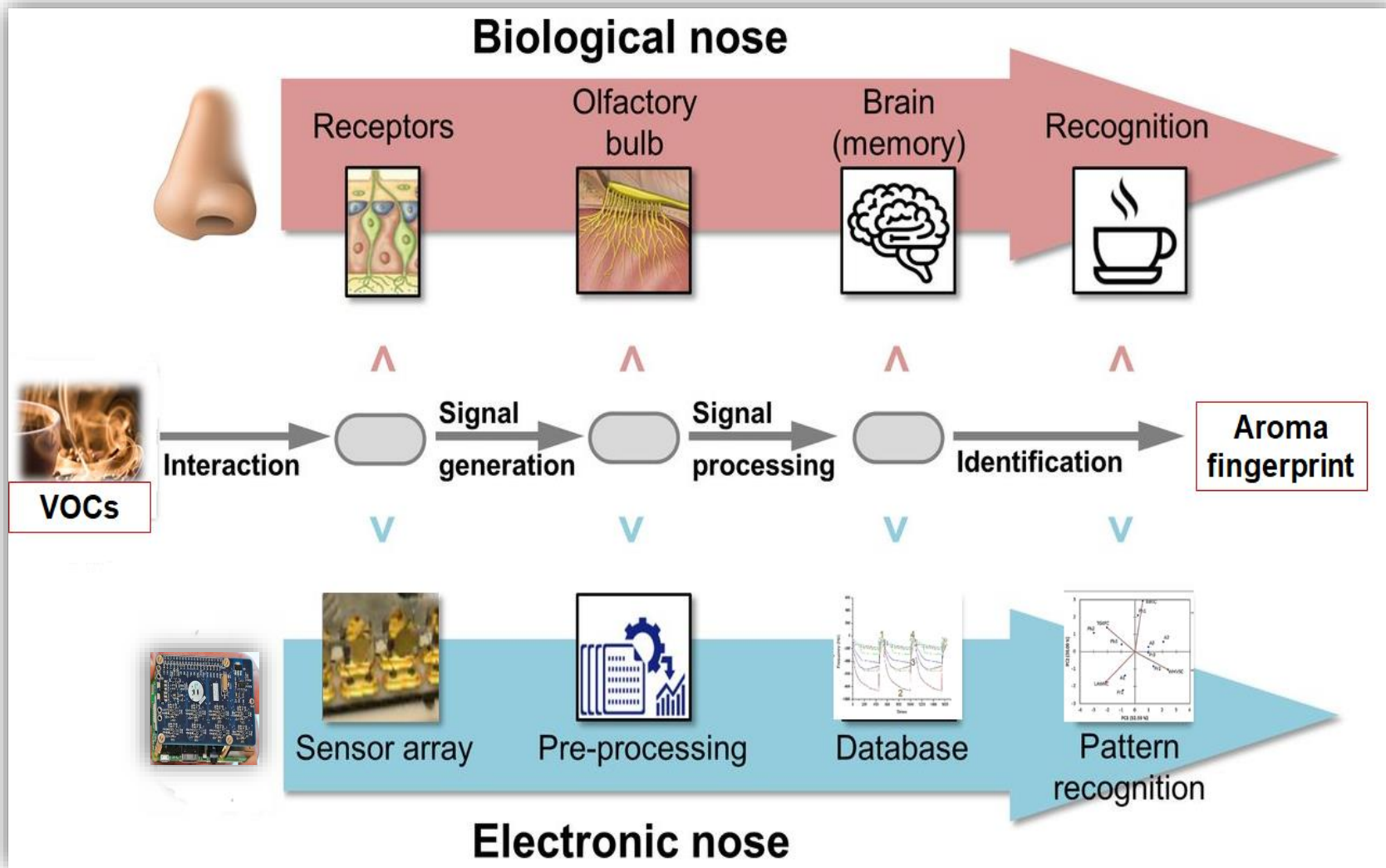

*'An electronic nose is an instrument, which comprises an array of electronic chemical sensors with partial specificity and an appropriate pattern-recognition system, capable of recognizing simple or complex odors' [1]*

....Different type of transducer for gas sensing....

### Field effect transistor

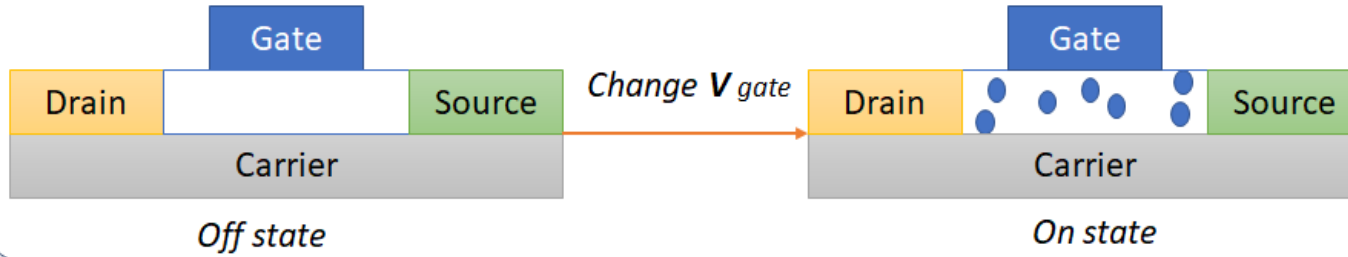

### Quartz crystal microbalance

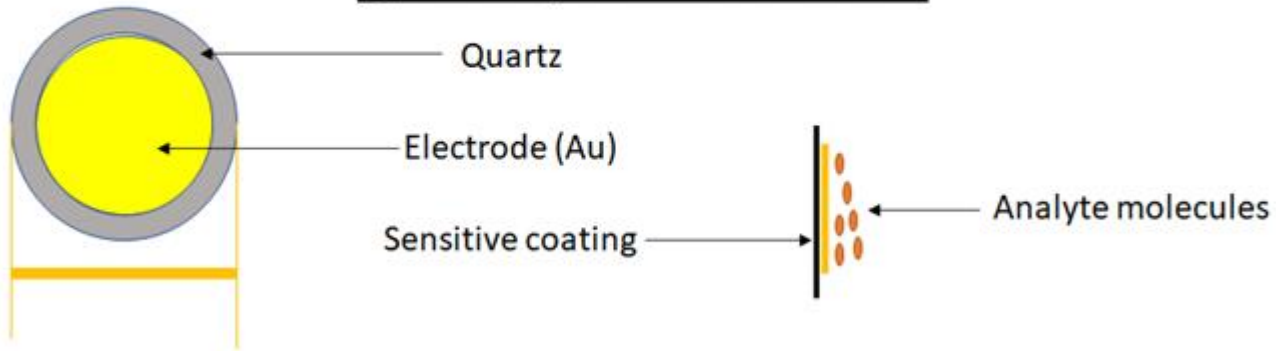

- ✓ *low costs*
- ✓ *easy realization*
- ✓ *ability to work in real-time*
- ✓ *short analysis times*

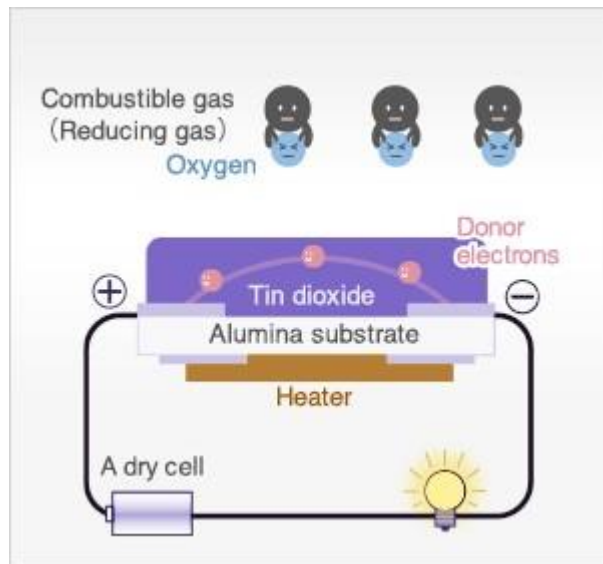

# MOS SENSORS

## Metal oxide semiconductors

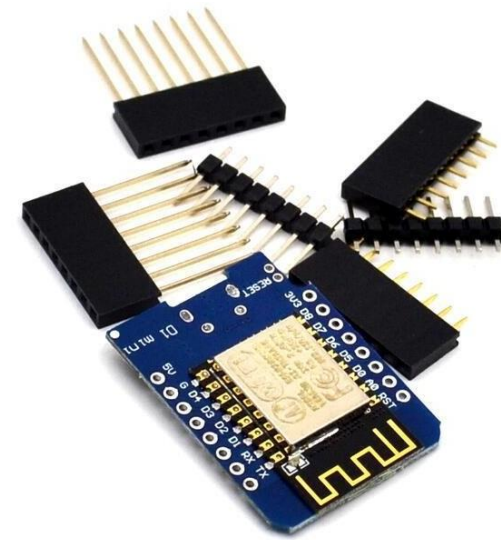

Constituted by three main parts:

- Ceramic substrate
- Heating wire or thermistor
- Semiconducting metal oxides film (Zn, Co, etc.)

**They measure conductivity changes onto the surface of the sensors induced by gases. Sensitive to combustion gases (hydrocarbons, NO, CO). Work at 300-400°C. An exchange between the gas and the oxygen on the film causes a change in resistance dependent on the adsorbed gas.**

# MOSFET SENSORS

## Field effect metal oxides transistors

Made by 3 parts:

- Semiconducting Silicon
- Insulating silica layer
- Catalytic metal (Pt, Pd, etc.)

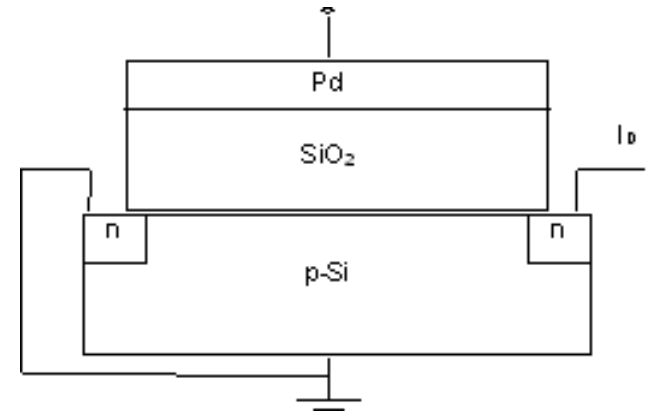

**Work as a transistor at applied potential at 140-170°C. Sensitive to compounds containing hydrogen (amines, aldehydes, esters, chetons, aromatics ed alcohols). Whwn a polar molecules interacts with the metal the electric field is modified and a change in current occurs. The device output is the voltage necessary to have the current back at the initial value.**



# Piezoelectric System Electronic nose

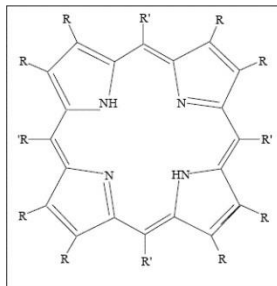
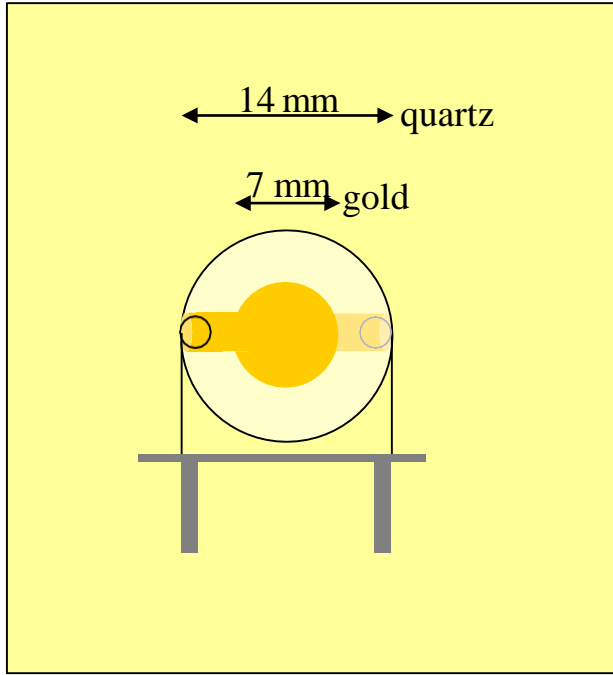

Butyloxy Tetra Phenyl Porphyrin

- Cu
- Co
- Zn
- Mn
- Fe
- Sn
- Ru
- Cr

# Measurement system

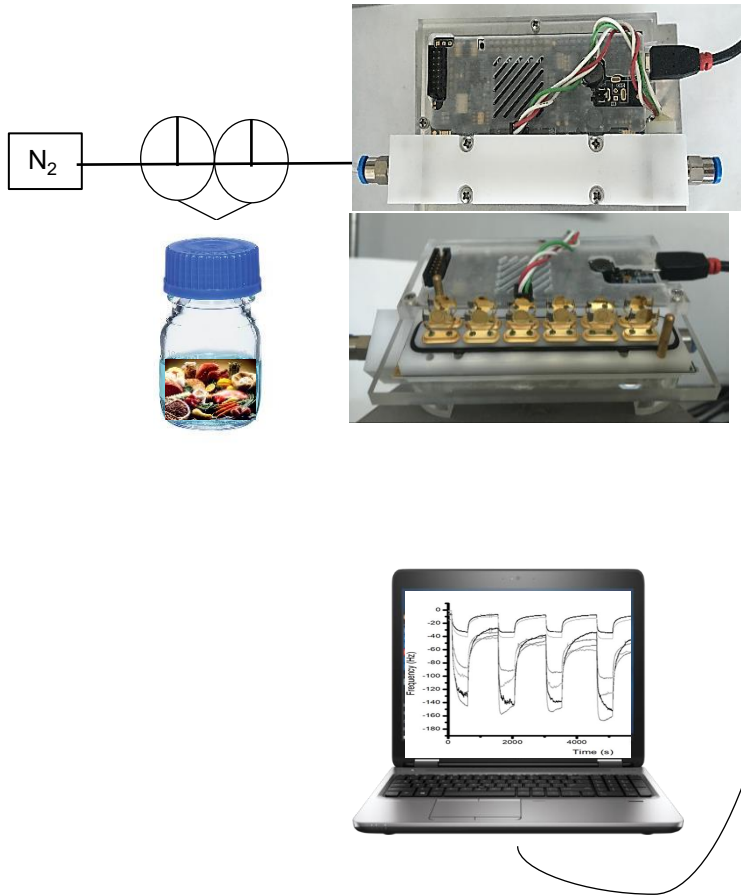

1. Start
2. Decrease
3. Equilibration
4. Baseline

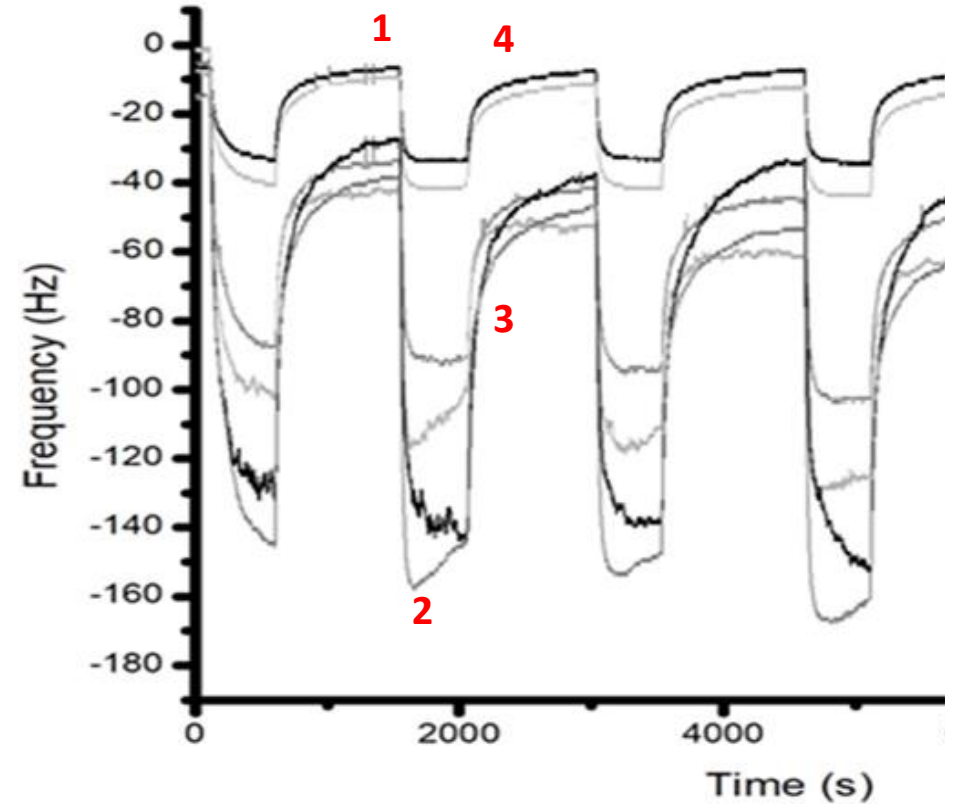

Frequency signals recorded with ZnONPs-peptides testing food

# Electronic nose

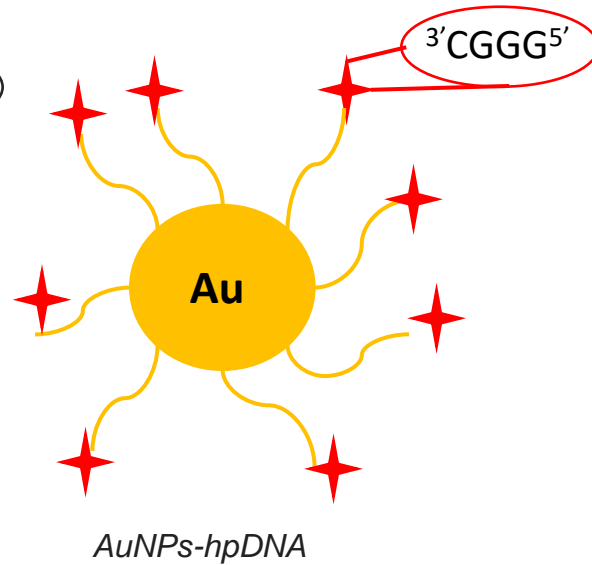
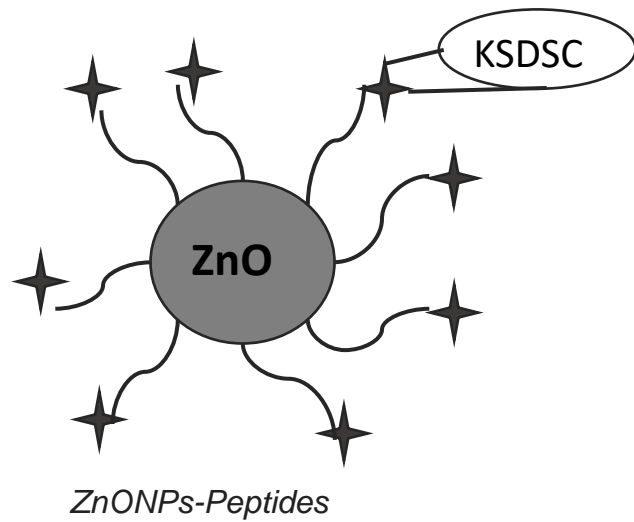
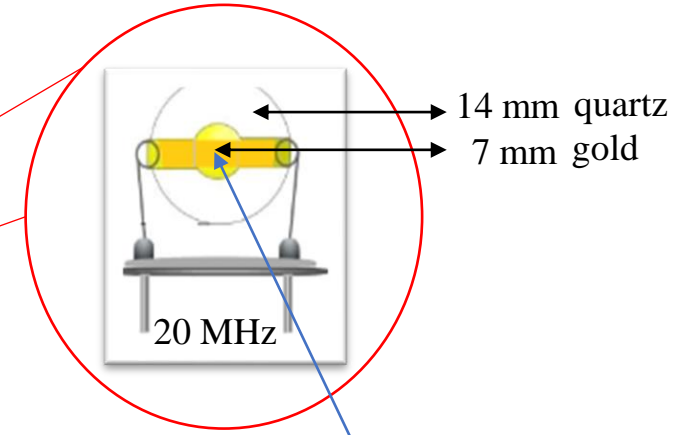
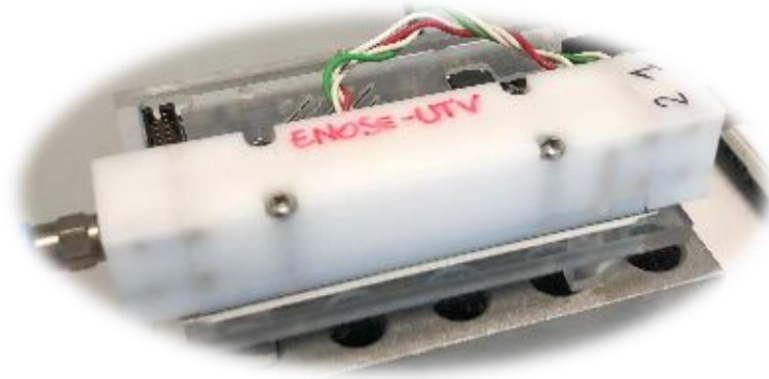

AuNPs-hpDNA

ZnONPs-Peptides

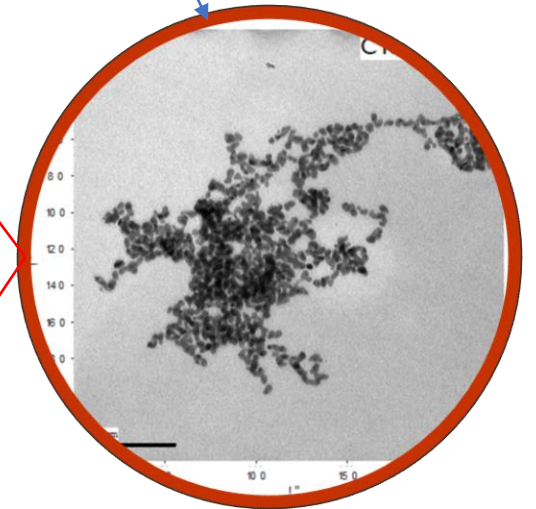

# Electronic nose sensor arrays

## GNP-Peptide based

- ① **AuNP-Glutathione**
- ① **AuNP-Cys-Gly**
- ① **AuNP-Cys**
- ① **AuNP-Thioglycolic Acid**
- ① **AuNP-Cys-Arg-Gln-Val-Phe**
- ① **AuNP-Cys-Ile-His-Asn-Pro**
- ① **AuNP-Cys-Ile-Gln-Pro-Val**
- ① **AuNP**

## Porphyrin based

- ① **Cu-Buti-TPP**
- ① **Co-Buti-TPP**
- ① **Zn-Buti-TPP**
- ① **Mn-Buti-TPP**
- ① **Fe-Buti-TPP**
- ① **Sn-Buti-TPP**
- ① **H<sub>2</sub>-Buti-TPP**
- ① **Mg-Buti-TPP**



- ✓ **Temperature: 40°C**
- ✓ **Equilibration time: 10 min**
- ✓ **15g in 100 mL lab bottle grated and melted**
- ✓ **N<sub>2</sub> = 4 L/h**

**Standard Samples**  
VS  
**Off-flavoured samples**

**PLS-DA analysis**

Off-Flavour	Process
3-methylbutanal	<b>Fermentation volatiles</b>
Phenylacetaldehyde	
Acetic Acid	<b>Conching process</b>
Tetramethylpyrazine	<b>Roasting Process</b>
2-acetylpyrrole	
2-nonenal	<b>Fat related (oxidation)</b>
2,4-decadienal (t,t)	

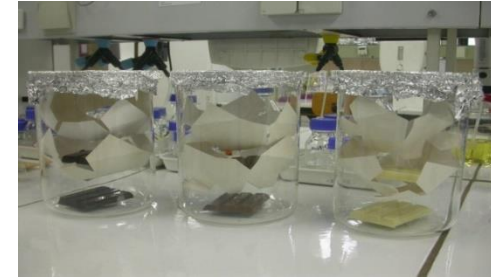

Off-flavours were preliminarily added in the cocoa butter to achieve the concentration of 125 ppm. One tea spoon of contaminated cocoa butter was then added to 400 g of chocolate to obtain an estimated final concentration in the sample of ~ 6ppm.

# Real samples

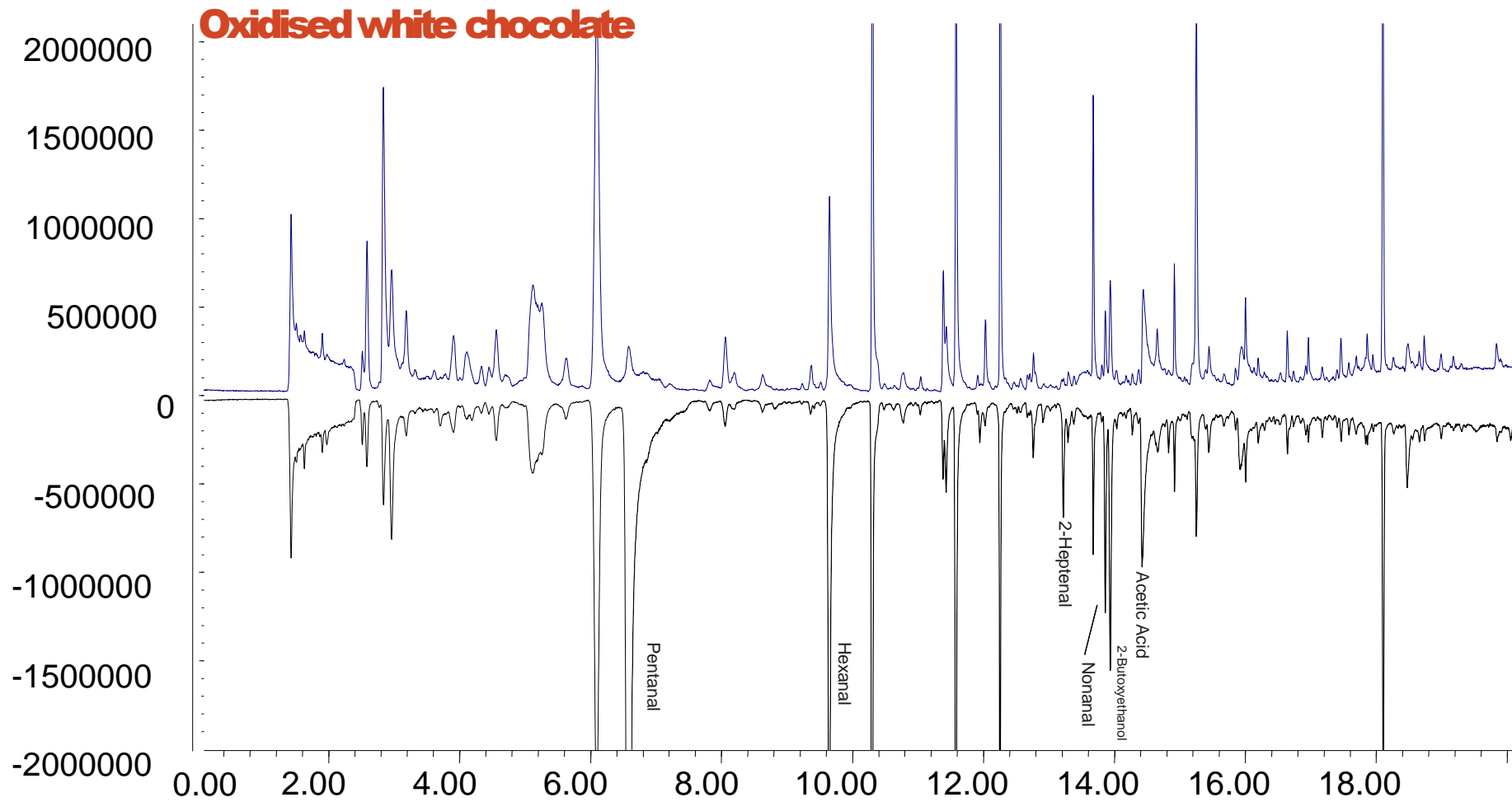

# Dark Chocolate

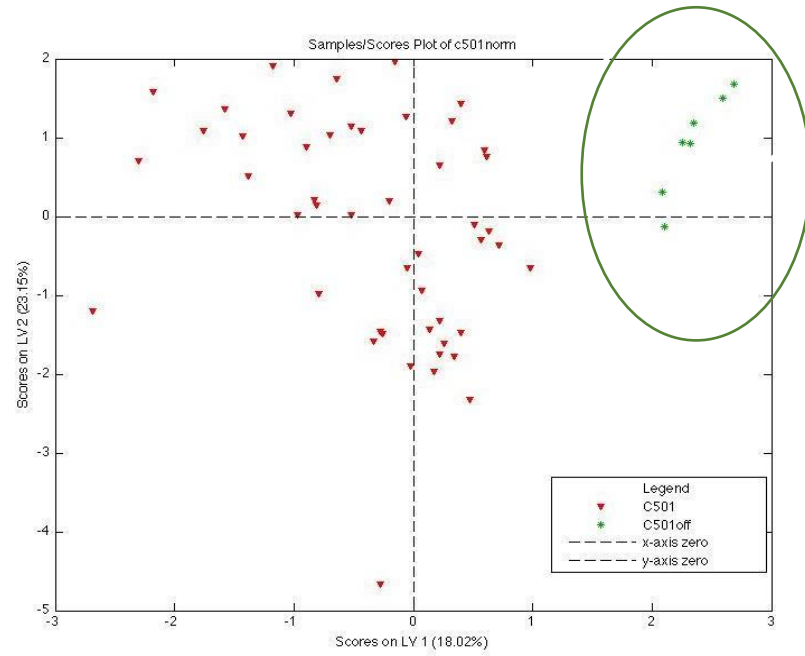

# White Chocolate

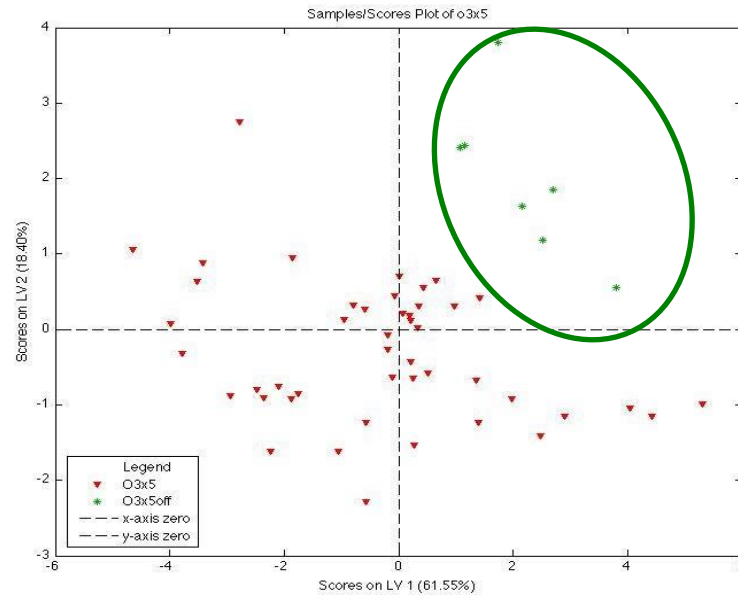
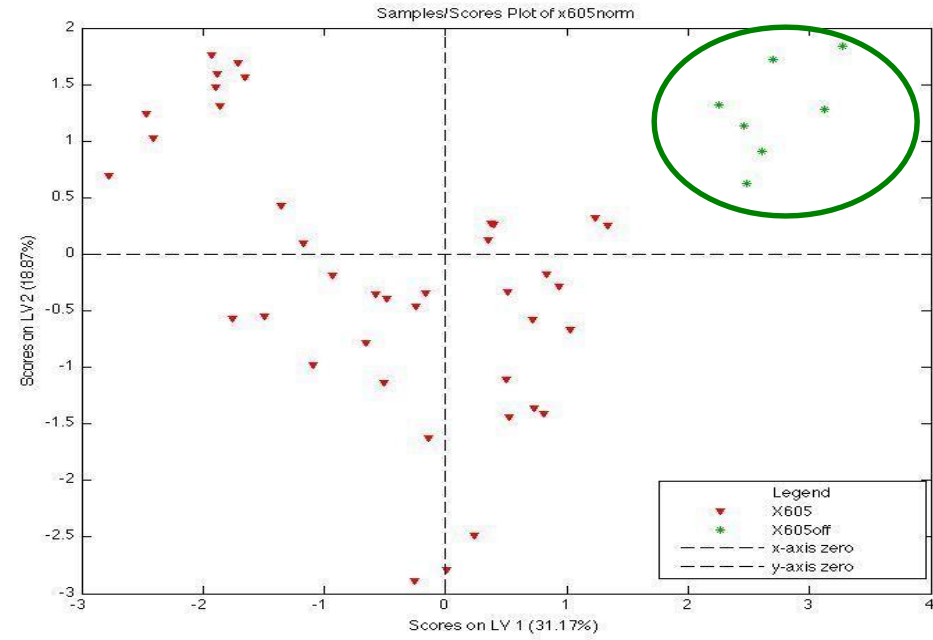

# Milk Chocolate



## AuNP-Peptide vs. Porphyrin PLS-DA analysis

## GNP-Peptide based

	Regular	Off	%
		Flavours	Correct
Regular	48	0	100
Off	0	7	100
flavours			

Tot. Correct:

	Regular	Off	%
		Flavours	Correct
Regular	39	0	100
Off	0	7	100
flavours			

Tot. Correct:

	Regular	Off	%
		Flavours	Correct
Regular	51	1	98
Off	0	7	100
flavours			

Tot. Correct:

## Porphyrin based

	Regular	Off	%
		Flavours	Correct
Regular	14	1	93
Off	1	9	90
flavours			

Tot. Correct:

	Regular	Off	%
		Flavours	Correct
Regular	13	1	92
Off	4	8	67
flavours			

Tot. Correct:

	Regular	Off	%
		Flavours	Correct
Regular	15	1	94
Off	4	8	67
flavours			

Tot. Correct:

# Virtual screening Peptides

## 6 Peptides studied

(KSDSC, WHVSC, LGFDC, IHRIC, LAWHC, TGKFC)

VS

## 14 volatile compounds

(different chemical classes, shapes, dimensions, hydrophobicity)

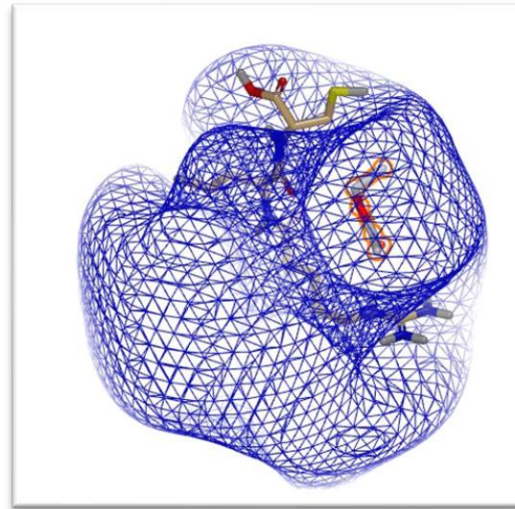

- Docking box generation 10 conformers for each peptide for identification of most probable bond sites and energy quantification involved in the docking simulation
- From 1 to 200 conformers for each volatile compound
- Binding score: average of all conformers

# Hp-DNA

hpDNA has been used as molecular switch for optical and electrochemical sensing

- The loop can be used as sensing elements also for VOCs
- A virtual screening of the entire library sequences of the loops is possible
- hpDNA can be easily bound to metal nanoparticles (AuNPs)

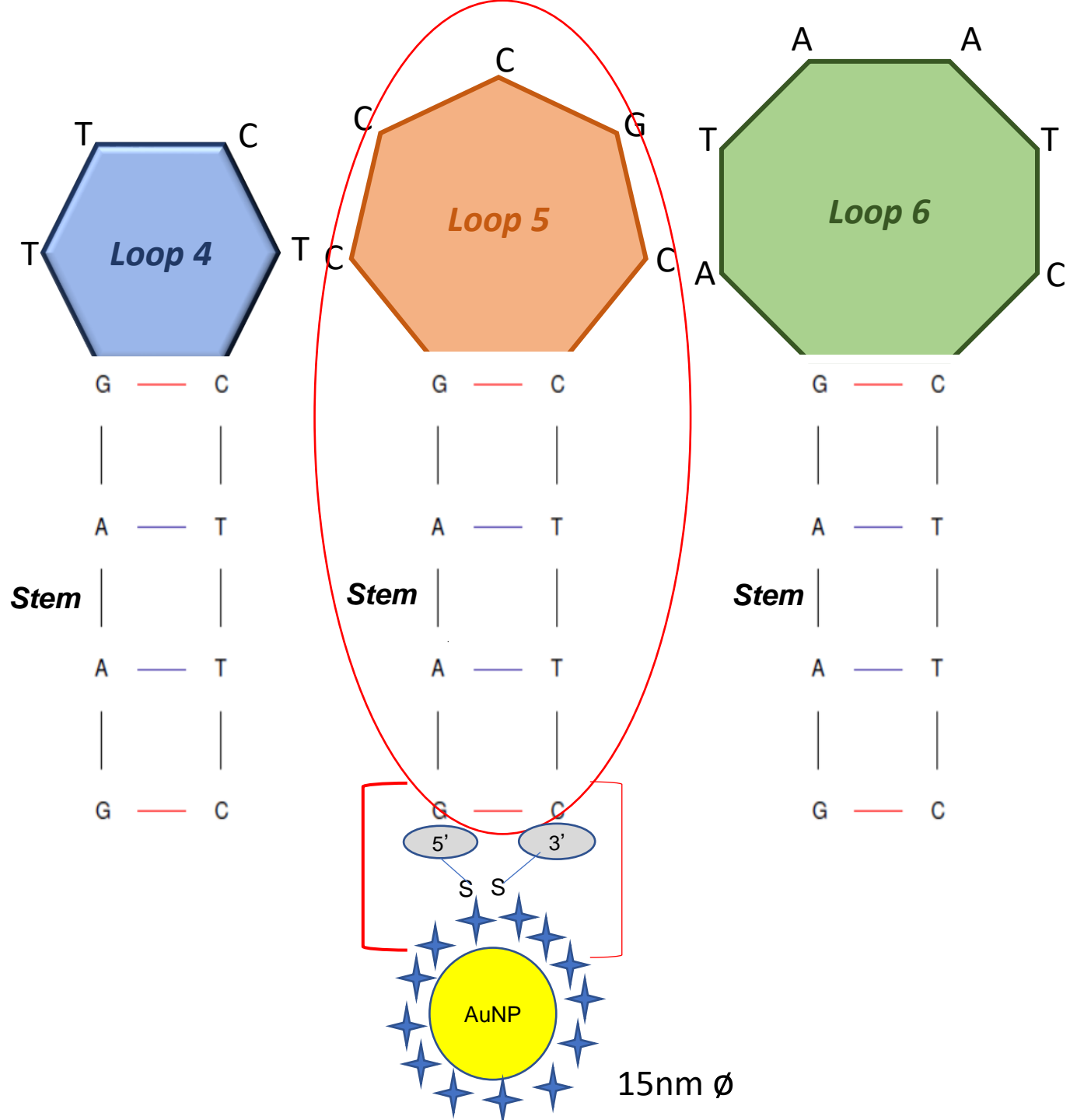

# Virtual screening of hp-DNA

Virtual screening procedure was aimed to test the virtual binding affinities of the hairpin loop versus different chemical classes:



- Alcohols (14 molecules);
- Aldehydes (13 molecules);
  - Esters (18 molecules);
  - Ketones (5 molecules).

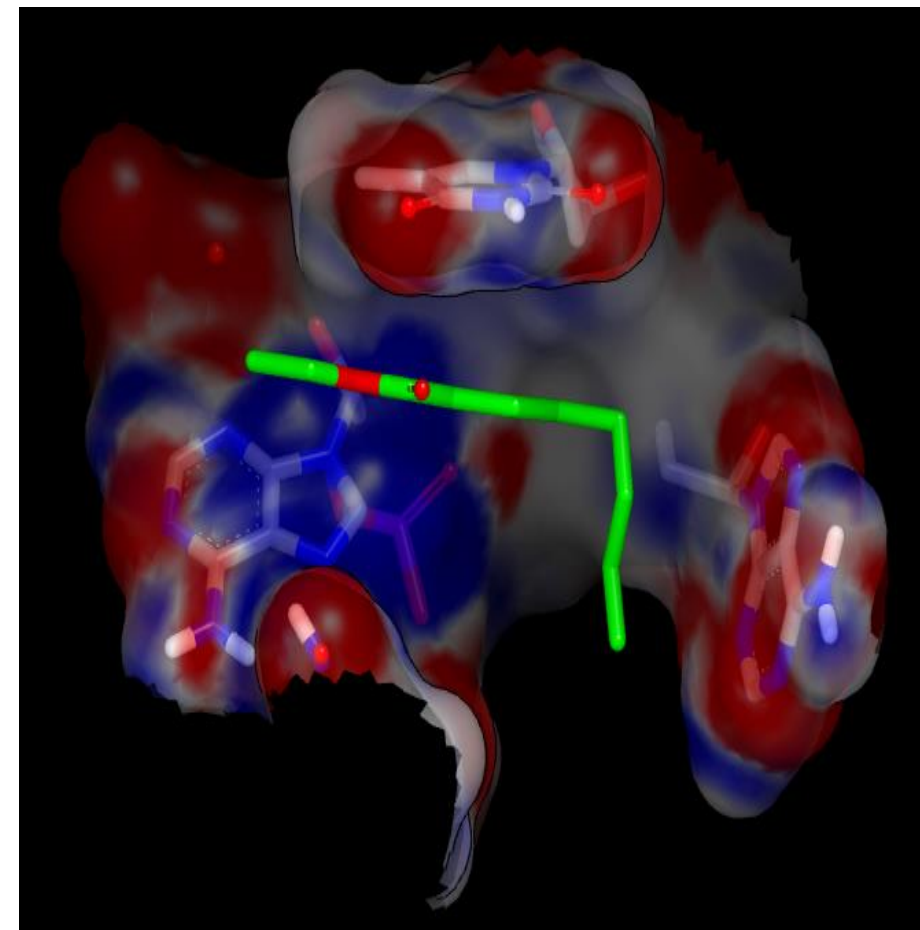

*Molecular Modeling : octanal-ATAATC*

# Electronic nose sequences...

n=20

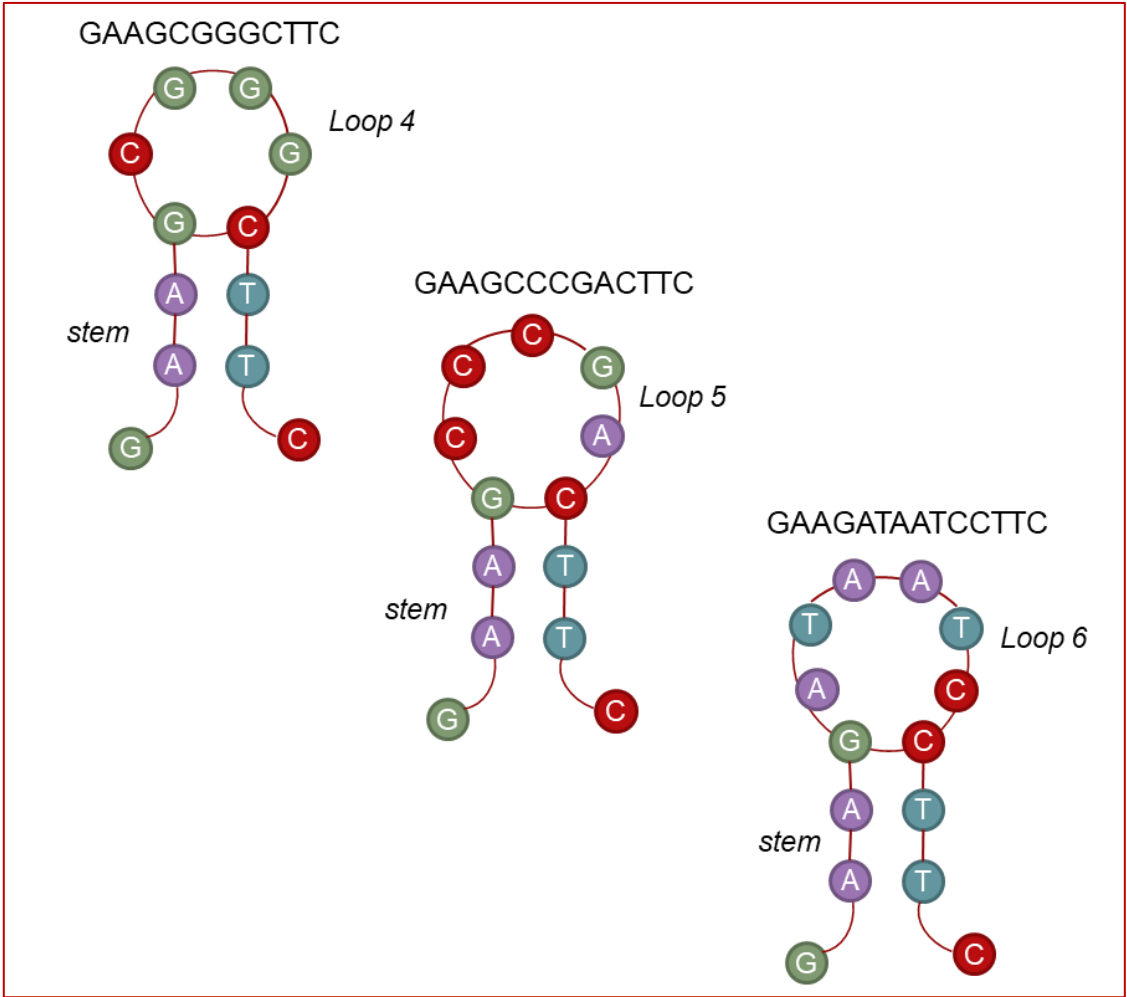
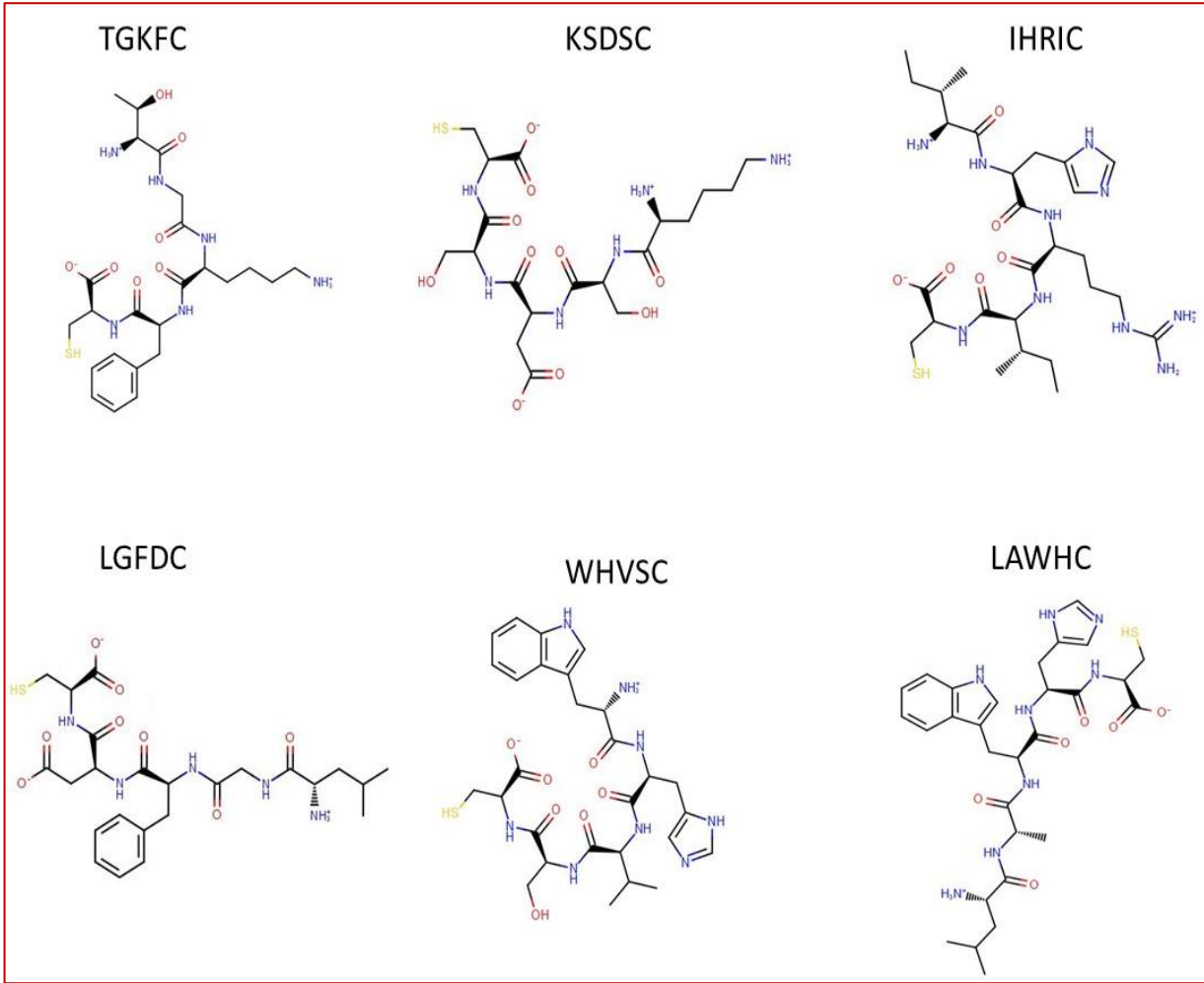

# E-nose analysis

5  $\mu\text{L}$  of the AuNPs-hpDNA and ZnO-Peptide suspension on each side of the QCM

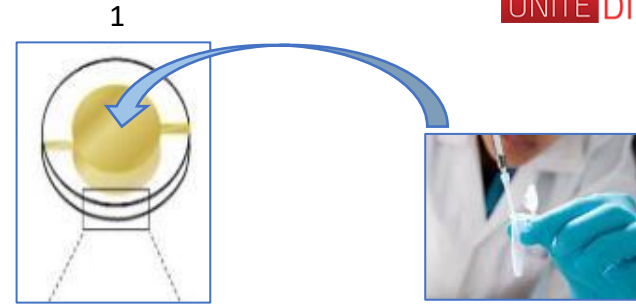

3  
✓ Aroma release in headspace of gas-tight bottle

5  
Measurement of aroma compounds; the frequency shift was taken as analytical signal

2  
✓ The samples was introduced in a gas-tight bottle (100 mL)

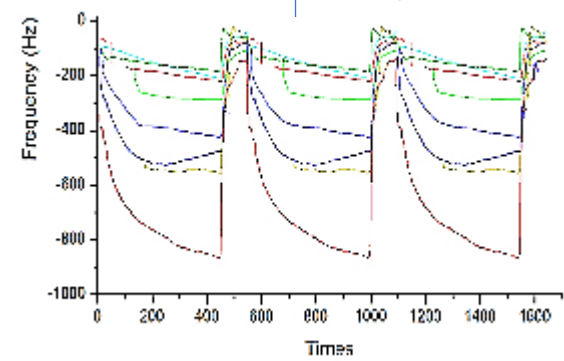
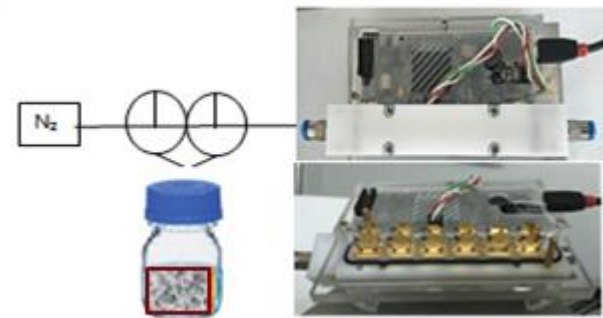

# SPME-GC/MS analysis

## Nist library

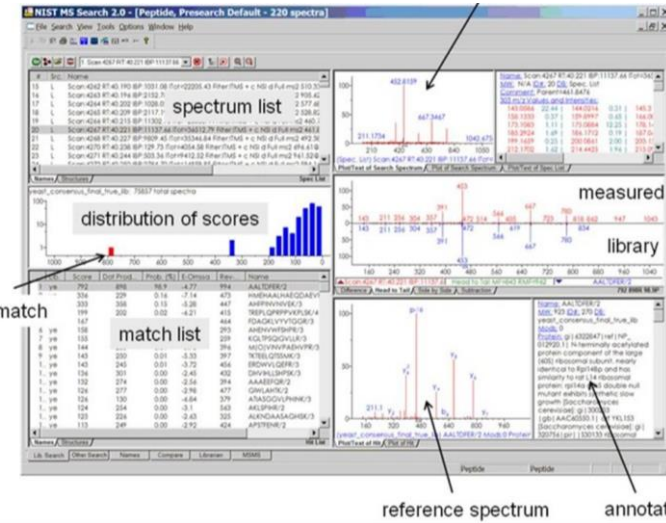

Confirmed by Retention index...

## headspace analysis



## Desorption



## Example...

Peak no.	RT <sup>a)</sup> (min)	RI <sub>Kov</sub> <sup>b)</sup>	RI <sub>cal</sub> <sup>c)</sup>	Identification <sup>d)</sup>	Metabolite	MF <sup>e)</sup>	m/z <sup>f)</sup>	Similarity (%)	Peak area (× 10 <sup>6</sup> area units) ± RSD (%)					
									DVB/CAR/PDMS <sup>g)</sup>	PDMS <sup>g)</sup>	CAR/PDMS <sup>g)</sup>	PDMS/DVB <sup>g)</sup>	PEG <sup>g)</sup>	PA
1	1.42	-	908	MS, RI	Isoprene	C <sub>6</sub> H <sub>8</sub>	32, 67, 53	96	0.1 ± 7.8	-	0.4 ± 1.2	0.7 ± 1.5	-	-
2	3.92	1007	1016	MS, RI, ST	α-Pinene	C <sub>10</sub> H <sub>16</sub>	93, 77, 121	93	0.7 ± 9.7	1.0 ± 2.8	0.6 ± 2.9	0.5 ± 2.5	0.1 ± 3.1	0.02 ± 8.2
3	4.77	1075	1057	MS, RI	Camphene	C <sub>10</sub> H <sub>16</sub>	93, 121, 41	94	0.04 ± 8.7	0.2 ± 9.5	0.1 ± 8.5	0.3 ± 3.2	0.01 ± 5.5	-
4	5.73	1116	1107	MS, RI, ST	β-Pinene	C <sub>10</sub> H <sub>16</sub>	93, 41, 69	91	2.4 ± 1.2	5.8 ± 3.9	3.0 ± 3.2	3.2 ± 8.0	0.5 ± 2.7	0.1 ± 1.3
5	8.79	1145	1135	MS, RI, ST	β-Myrcene	C <sub>10</sub> H <sub>16</sub>	93, 69, 41	97	153.3 ± 1.1	191.1 ± 1.7	159.3 ± 1.9	126.7 ± 1.9	27.7 ± 2.5	7.6 ± 5.0
6	9.53	1180	1172	MS, RI, ST	Limonene	C <sub>10</sub> H <sub>16</sub>	68, 93, 79	93	1.3 ± 1.3	1.1 ± 5.0	1.2 ± 5.0	1.7 ± 6.6	0.3 ± 2.9	0.1 ± 2.1
7	10.01	1185	1182	MS, RI	β-Phellandrene	C <sub>10</sub> H <sub>16</sub>	93, 77, 136	95	1.1 ± 2.6	0.2 ± 6.8	0.9 ± 5.1	1.1 ± 1.0	-	-
8	11.64	1242	1246	MS, RI	trans-β-Cimene	C <sub>10</sub> H <sub>16</sub>	93, 79, 41	89	0.1 ± 1.2	0.1 ± 7.4	0.1 ± 1.1	0.1 ± 2.4	0.01 ± 4.2	-
9	11.79	1262	1267	MS, RI, ST	α-Terpinene	C <sub>10</sub> H <sub>16</sub>	93, 136, 77	91	0.1 ± 1.4	0.1 ± 3.3	0.1 ± 2.6	0.1 ± 2.7	0.01 ± 3.5	-
10	12.48	1274	1279	MS, RI	cis-β-Cimene	C <sub>10</sub> H <sub>16</sub>	93, 76, 41	92	2.1 ± 1.3	2.6 ± 3.2	2.2 ± 2.5	1.5 ± 2.5	0.2 ± 1.0	0.03 ± 1.3
11	13.15	-	1290	MS, RI, ST	o-Cymene	C <sub>10</sub> H <sub>14</sub>	119, 32, 134	95	0.1 ± 1.9	0.1 ± 2.7	0.1 ± 1.3	0.04 ± 1.3	0.01 ± 1.2	-
12	13.75	1284	1280	MS, RI	α-Terpinolene	C <sub>10</sub> H <sub>16</sub>	93, 121, 136	97	0.1 ± 3.4	0.1 ± 3.6	0.1 ± 1.0	0.1 ± 2.8	0.01 ± 1.1	-
13	22.88	1295	1305	MS, RI	Perillene	C <sub>10</sub> H <sub>14</sub> O	69, 81, 150	96	0.2 ± 1.5	0.2 ± 8.6	0.2 ± 2.9	0.2 ± 2.5	0.03 ± 2.3	-
14	26.07	1476	1481	MS, RI	Ylangene	C <sub>15</sub> H <sub>24</sub>	105, 119, 161	95	0.4 ± 2.0	0.2 ± 5.8	0.3 ± 2.0	0.2 ± 3.2	-	-
15	26.64	1480	1491	MS, RI	α-Cubebene	C <sub>15</sub> H <sub>24</sub>	161, 119, 105	91	1.2 ± 2.0	0.8 ± 1.7	0.8 ± 1.6	0.7 ± 3.5	0.1 ± 2.2	0.3 ± 1.6
16	33.62	1663	1621	MS, RI, ST	α-Humulene	C <sub>15</sub> H <sub>24</sub>	133, 93, 69	96	48.1 ± 7.5	52.8 ± 2.0	41.4 ± 1.5	36.8 ± 3.7	10.9 ± 2.6	3.1 ± 8.0
17	38.63	1657	1665	MS, RI, ST	β-Caryophyllene	C <sub>15</sub> H <sub>24</sub>	93, 80, 121	93	42.4 ± 4.1	21.3 ± 2.3	16.8 ± 1.9	15.4 ± 3.6	3.6 ± 2.5	1.0 ± 2.2
18	39.90	1681	1687	MS, RI	γ-Murolene	C <sub>15</sub> H <sub>24</sub>	161, 105, 119	88	1.7 ± 2.7	1.3 ± 2.8	0.9 ± 1.8	0.8 ± 1.4	0.6 ± 3.3	0.1 ± 1.9
19	41.40	1566	1554	MS, RI	Methyl geranate	C <sub>11</sub> H <sub>18</sub> O <sub>2</sub>	69, 41, 114	90	3.7 ± 1.1	3.1 ± 4.2	1.3 ± 3.1	2.3 ± 2.0	0.4 ± 2.8	0.1 ± 3.2
20	41.89	1724	1713	MS, RI, ST	α-Selinene	C <sub>15</sub> H <sub>24</sub>	189, 161, 93	92	0.8 ± 9.8	0.2 ± 2.3	0.2 ± 6.8	0.4 ± 4.1	0.2 ± 3.0	0.04 ± 2.3
21	42.50	-	1744	MS, RI	α-Murolene	C <sub>15</sub> H <sub>24</sub>	105, 161, 93	89	0.3 ± 2.5	0.3 ± 1.8	0.2 ± 1.6	0.2 ± 4.1	0.1 ± 3.6	0.02 ± 1.4
22	44.59	1749	1740	MS, RI, ST	(+)-β-Cadinene	C <sub>15</sub> H <sub>24</sub>	161, 134, 119	89	1.9 ± 2.2	1.6 ± 1.8	1.0 ± 1.5	1.0 ± 4.2	0.4 ± 2.6	0.1 ± 1.0
23	45.88	-	1755	MS, RI, ST	Cubene	C <sub>15</sub> H <sub>24</sub>	119, 105, 161	93	0.3 ± 5.4	0.2 ± 5.7	0.1 ± 1.2	0.2 ± 4.4	0.1 ± 3.8	0.01 ± 1.1
24	46.60	-	1769	MS, RI	Naphthalene H4,7DM 1R <sup>h)</sup>	C <sub>15</sub> H <sub>24</sub>	105, 161, 91	96	0.2 ± 2.5	0.1 ± 2.1	0.1 ± 2.0	0.1 ± 4.7	0.1 ± 6.3	0.01 ± 9.8
25	48.27	-	1780	MS, RI	β-Fenchene	C <sub>10</sub> H <sub>16</sub>	79, 32, 67	95	0.1 ± 3.0	0.1 ± 4.6	0.02 ± 2.7	0.04 ± 5.2	0.01 ± 1.1	0.01 ± 1.0
26	49.30	1800	1789	MS, RI, ST	3-Carene	C <sub>10</sub> H <sub>16</sub>	69, 93, 41	98	0.9 ± 2.5	0.4 ± 1.1	0.3 ± 2.3	0.4 ± 5.0	0.3 ± 1.2	0.04 ± 8.0
27	51.68	1825	1835	MS, RI, ST	cis-Geraniol	C <sub>10</sub> H <sub>18</sub> O	69, 41, 93	92	0.2 ± 2.0	0.1 ± 3.9	0.1 ± 3.2	0.1 ± 2.0	0.1 ± 1.0	-
<b>Total peak area (× 10<sup>6</sup>)</b>									<b>263.7</b>	<b>285.0</b>	<b>231.8</b>	<b>194.4</b>	<b>45.6</b>	<b>12.4</b>
<b>Average RSD (%)</b>									<b>3.4</b>	<b>3.9</b>	<b>2.7</b>	<b>3.4</b>	<b>2.8</b>	<b>3.9</b>
<b>No. metabolite by fiber</b>									<b>27</b>	<b>26</b>	<b>27</b>	<b>27</b>	<b>24</b>	<b>17</b>

a) Retention time (min).  
b) Kovat's retention index reported in the literature for BP-20 capillary column or equivalents [53].  
c) Kovat's retention index relative n-alkanes(C<sub>8</sub>-C<sub>20</sub>) on a BP-20 capillary column.

# Headspace Volatile Evaluation of Carrot Samples Comparison of GC/MS and AuNPs-hpDNA-Based E-Nose



- Monitoring and control of vegetable ripening are important parameters in the food industry, since the maturation state during harvest, storage and distribution on the market defines the quality of the finished product;
- To prevent enzymatic reactions during processing, storage and thawing, the packaged carrots were blanched at 95 °C for 8 min in a water bath
- 3 g of blanched carrots were placed in 20 ml gas-tight vials and hermetically sealed with a gas-tight septum. A total of 24 vials were prepared for each temperature tested (-18 °C, 4 °C, 25 °C, 40 °C), in order to have three replicates (three different vials) for each day of measurement (1, 4, 8, 12, 19, 26 days). Thus, a total of 140 vials for E-nose and GC-MS have been analyzed. Each vial was used only once for either the GC-MS or E-nose measurement and the relative sample was discarded.



Volatile compounds	GC area (%)																				
	Storage time (days)																				
	-18 °C					4 °C						25 °C						40 °C			
	1	4	8	12	19	1	4	8	12	19	26	1	4	8	12	19	26	1	4	8	12
α-phellandrene	n.d	n.d	n.d	n.d	n.d	1	1	1	1	1	n.d	n.d**	1	n.d	n.d	1	n.d	7	1	n.d	n.d
β-phellandrene	2	1	2	1	1	3	3	2	1	4	1	n.d	3	1	1	2	n.d	n.d	n.d	n.d	n.d
terpinolene	n.d	n.d	1	1	0	1	1	1	n.d	1	n.d	n.d	1	n.d	n.d	1	n.d	n.d	n.d	n.d	n.d
α-pinene	14	9	12	12	10	14	12	14	14	18	8	12	7	12	11	15	2	n.d	10	15	5
(-) -β-pinene	3	2	3	3	3	3	3	3	3	3	2	2	3	2	2	3	1	n.d	n.d	n.d	2
β-pinene	3	2	3	2	6	5	6	3	3	5	1	2	6	1	1	4	n.d	5	3	3	2
Octanal	1	1	n.d	n.d	n.d	1	1	1	1	n.d	n.d	1	n.d	n.d	n.d	n.d	n.d	n.d	n.d	n.d	n.d
γ-terpinene	7	8	9	10	7	8	9	7	8	4	1	12	7	6	5	7	n.d	21	9	9	5
β-farnesene	1	1	1	1	1	1	1	1	1	n.d	1	1	1	1	1	1	2	n.d	n.d	n.d	n.d
α-caryophyllene	1	1	1	1	2	2	1	1	1	1	5	1	2	1	2	1	2	n.d	n.d	n.d	n.d
β-copaene	2	2	2	n.d	4	2	2	3	n.d	n.d	n.d	2	1	2	2	2	5	n.d	n.d	n.d	n.d
myristicin	1	1	1	1	2	1	1	1	1	1	5	2	1	2	n.d	1	4	n.d	n.d	n.d	n.d
elemicin	n.d	1	n.d	n.d	n.d	n.d	n.d	1	n.d	n.d	4	1	n.d	1	1	n.d	2	n.d	n.d	n.d	n.d
butane-2,3-diol	n.d	n.d	n.d	n.d	n.d	n.d	n.d	n.d	n.d	n.d	n.d	n.d	n.d	2	2	5	13	n.d	n.d	n.d	3
acetoin	n.d	n.d	n.d	n.d	n.d	n.d	n.d	n.d	n.d	n.d	n.d	n.d	n.d	9	3	6	15	5	3	5	6
ethanol	n.d	n.d	n.d	n.d	n.d	n.d	n.d	n.d	n.d	n.d	n.d	n.d	n.d	n.d	n.d	n.d	n.d	5	n.d	n.d	6
lactamide	n.d	n.d	n.d	n.d	n.d	n.d	n.d	n.d	n.d	n.d	n.d	n.d	n.d	n.d	n.d	n.d	n.d	4	11	16	7
3-methylbutan-1-ol	n.d	n.d	n.d	n.d	n.d	n.d	n.d	n.d	n.d	n.d	n.d	n.d	n.d	n.d	n.d	1	2	1	3	3	3

\*(mean value of n=3 repetitions); \*\*n.d.: not detected.

Results of the gas-chromatographic (GC) analysis of the headspace of carrots samples. Data are expressed as % of the total GC area\*.

Carrots Sample	CGGG	TTGG	CTGCAA	CAGC	TAAGT	AAGTA	ATAATC	CCCGA
25°C/1	145	199	314	187	409	566	686	147
4°C/1	118	221	132	155	417	468	564	107
-18°C/1	111	241	199	150	415	485	529	127
25°C/4	103	259	323	164	495	575	645	146
4°C/4	107	230	317	159	535	492	608	156
-18°C/4	101	208	244	155	577	513	603	165
25°C/8	148	228	339	237	544	462	787	216
4°C/8	130	204	179	174	480	632	701	180
-18°C/8	129	188	197	140	498	493	603	175
25°C/12	127	201	311	182	529	564	716	192
4°C/12	126	180	414	147	470	553	660	141
-18°C/12	105	205	403	166	602	495	664	148
25°C/19	87	131	120	100	374	515	565	135
4°C/19	86	257	301	145	483	696	600	160
-18°C/19	114	224	307	118	421	662	607	150
25°C/26	46	88	289	161	146	583	494	140
4°C/26	64	118	370	101	358	497	576	145
40°C/1	41	98	250	176	169	468	755	175
40°C/3	51	146	252	192	160	507	733	214
40°C/4	53	143	235	194	168	507	693	167
40°C/9	45	217	263	150	239	453	686	168

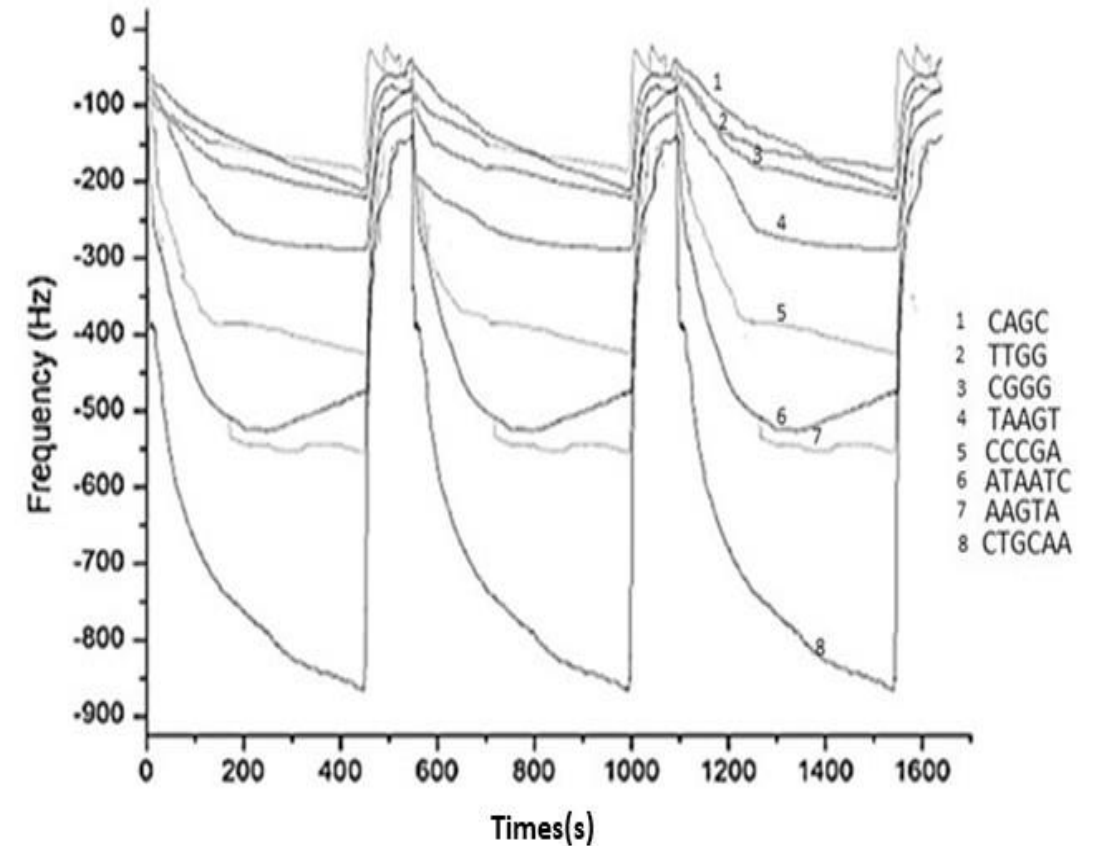

Frequency signal recorded with AuNPs-hpDNA testing carrots samples in triplicate

Frequency shift (Hz) response of the HpDNA sensors array for the carrots samples. The coefficient of variation calculated using three measurements taken in three different days was in all cases below 15%.

## GC-MS

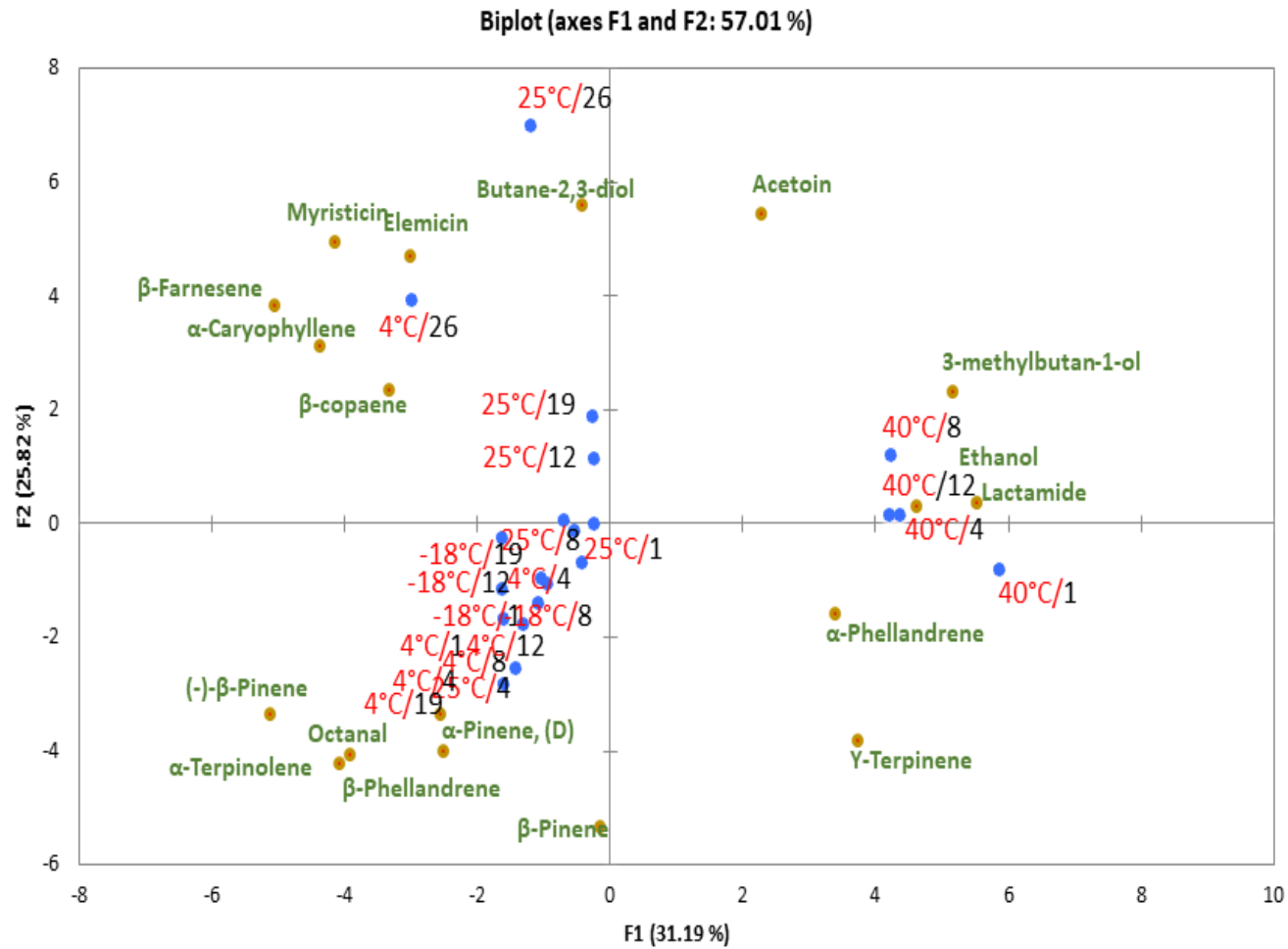

## E-nose

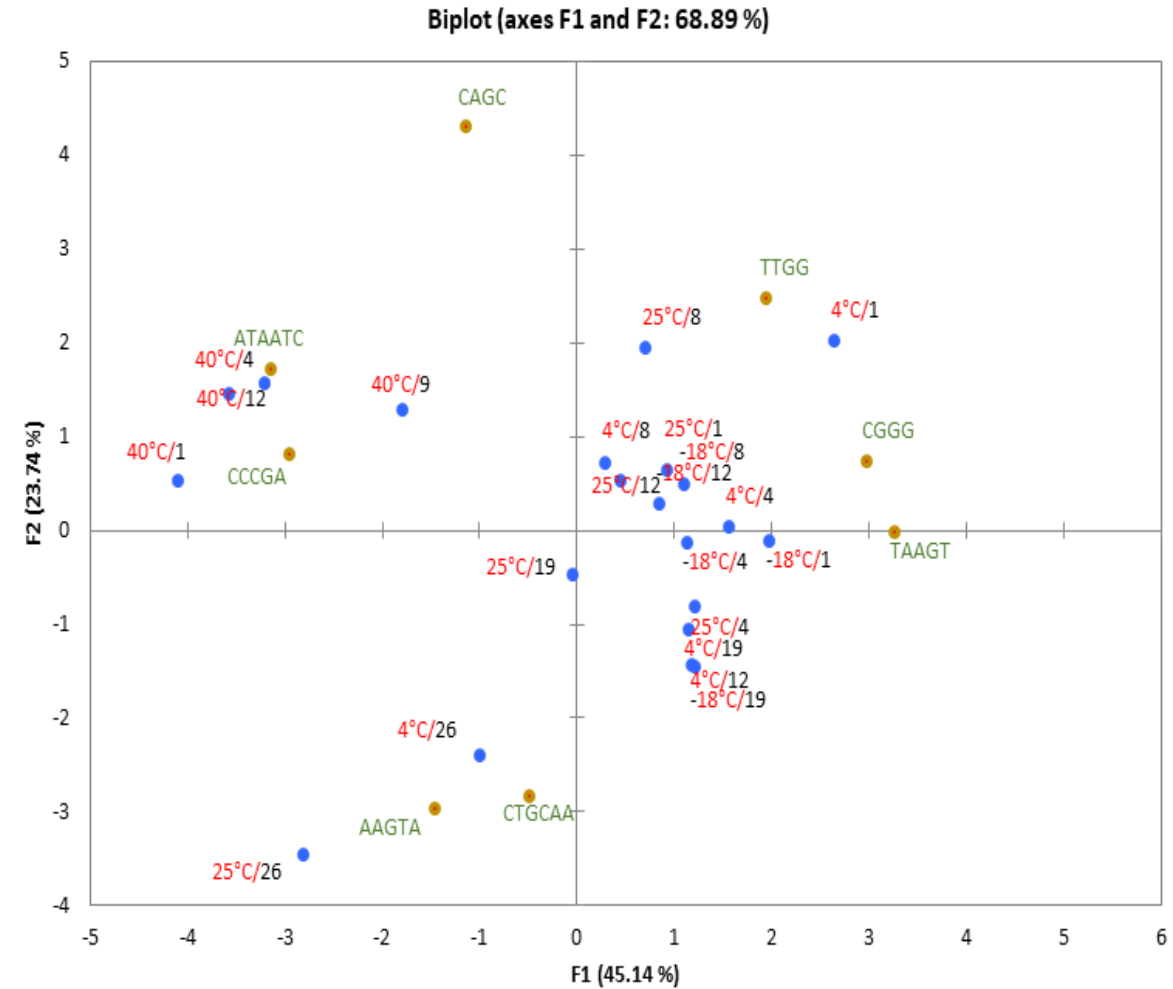

PCA of the GC-MS/SPME response of carrot samples stored for different time at various temperature. Data are expressed in (Relative Abundance %) before PCA

PCA biplot (scores and loadings) of the E-nose response to carrots samples. Data were normalized before PCA

# Surface plasmon resonance imaging

## home-made SPRI system

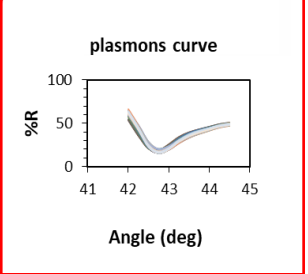
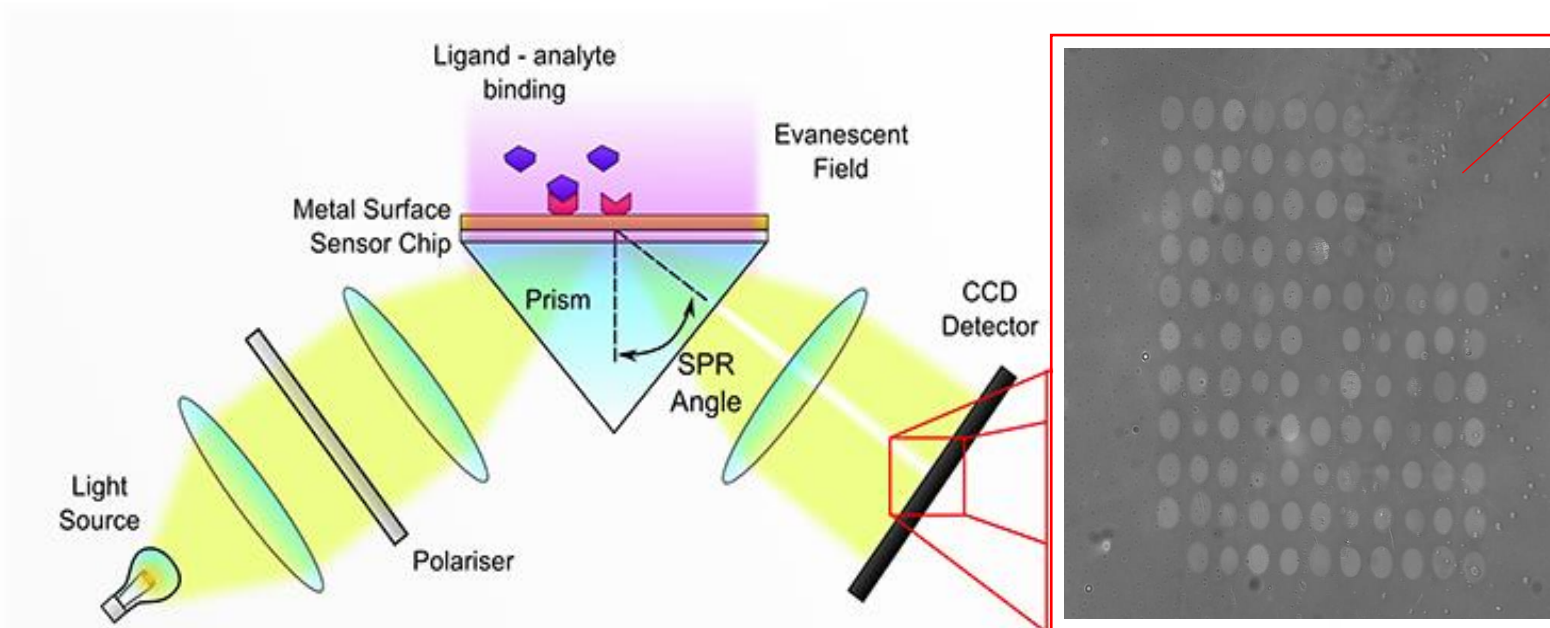

- 104 spot
- 12 peptides at different concentration: 200 $\mu$ M and 400 $\mu$ M
- 14 hpDNA: 16.8 $\mu$ M
- 1.2 nL volume drop ( $\leq$ 1mm)

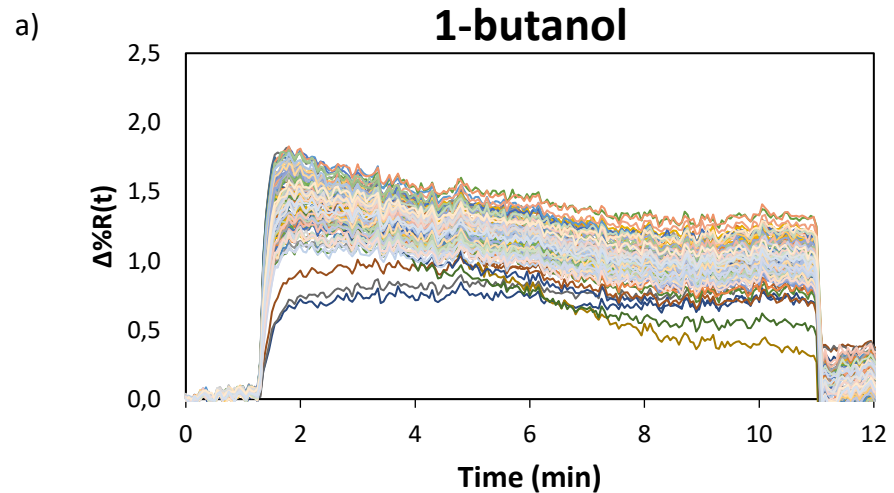

1-butanol

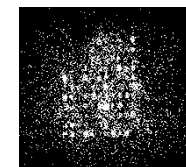

1-pentanol

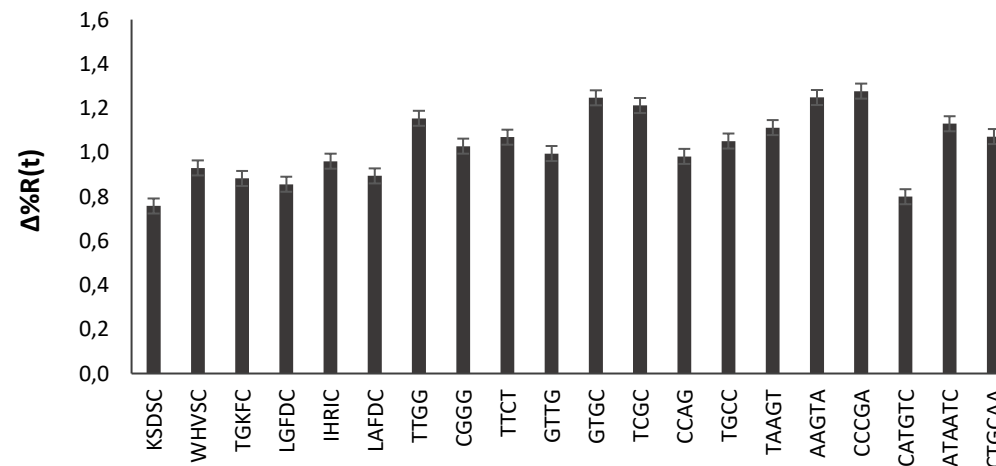
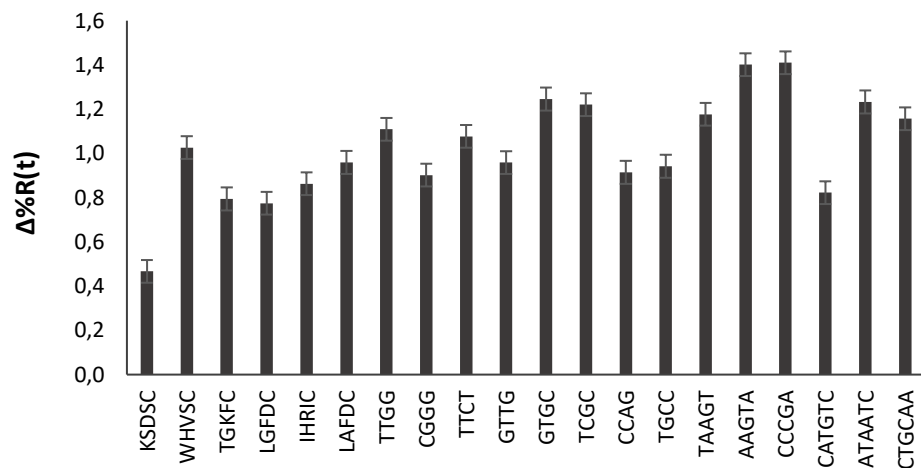

b)

nonanal

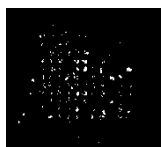
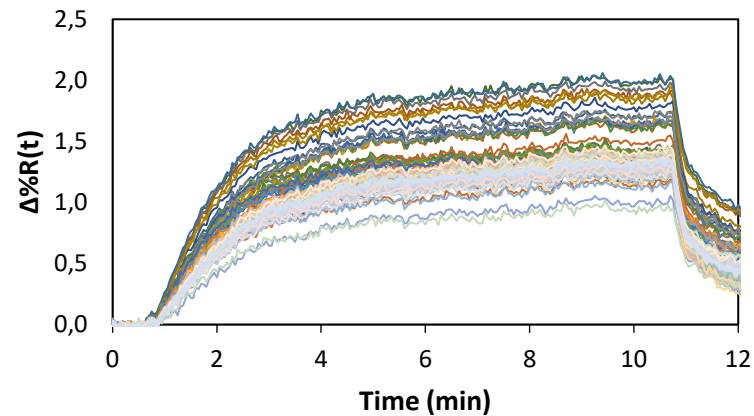

hexanal

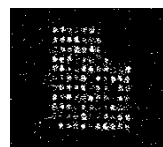
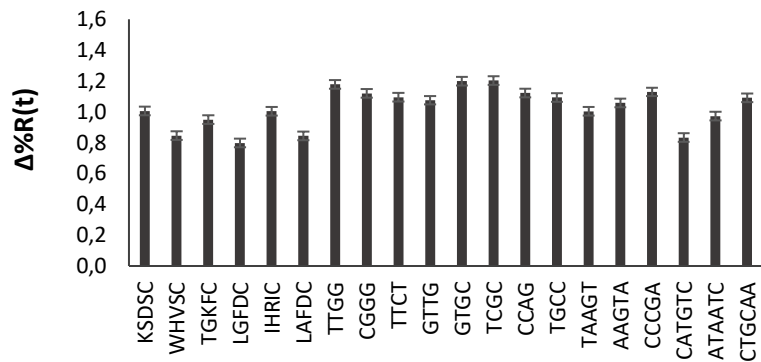

nonanal

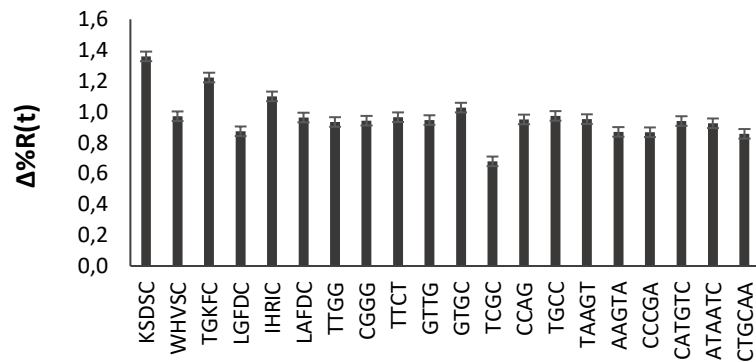

trans-2-nonenal

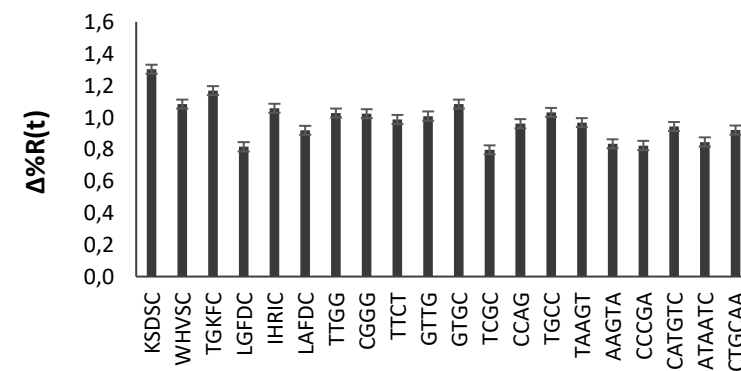

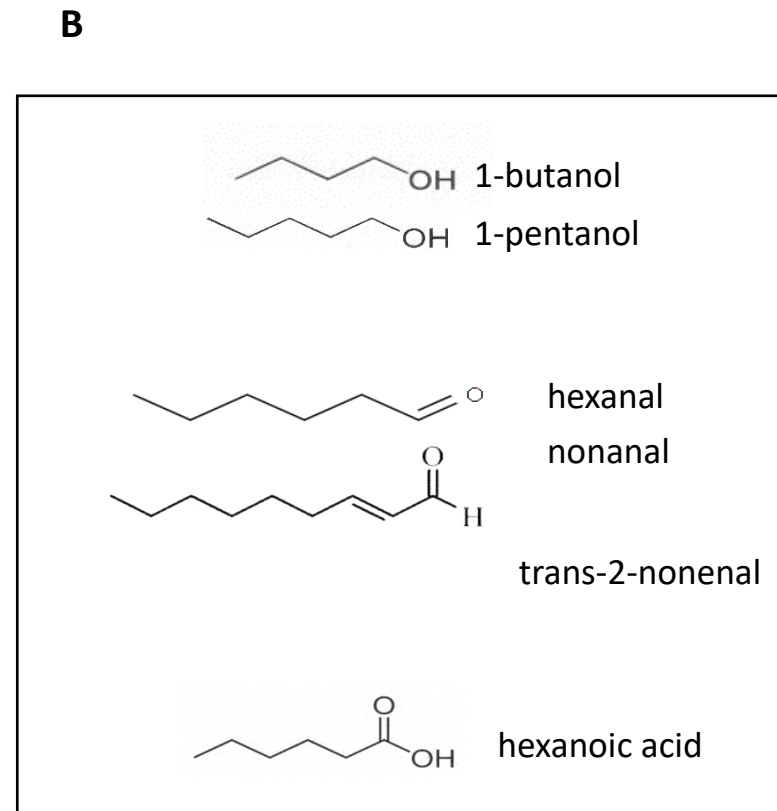
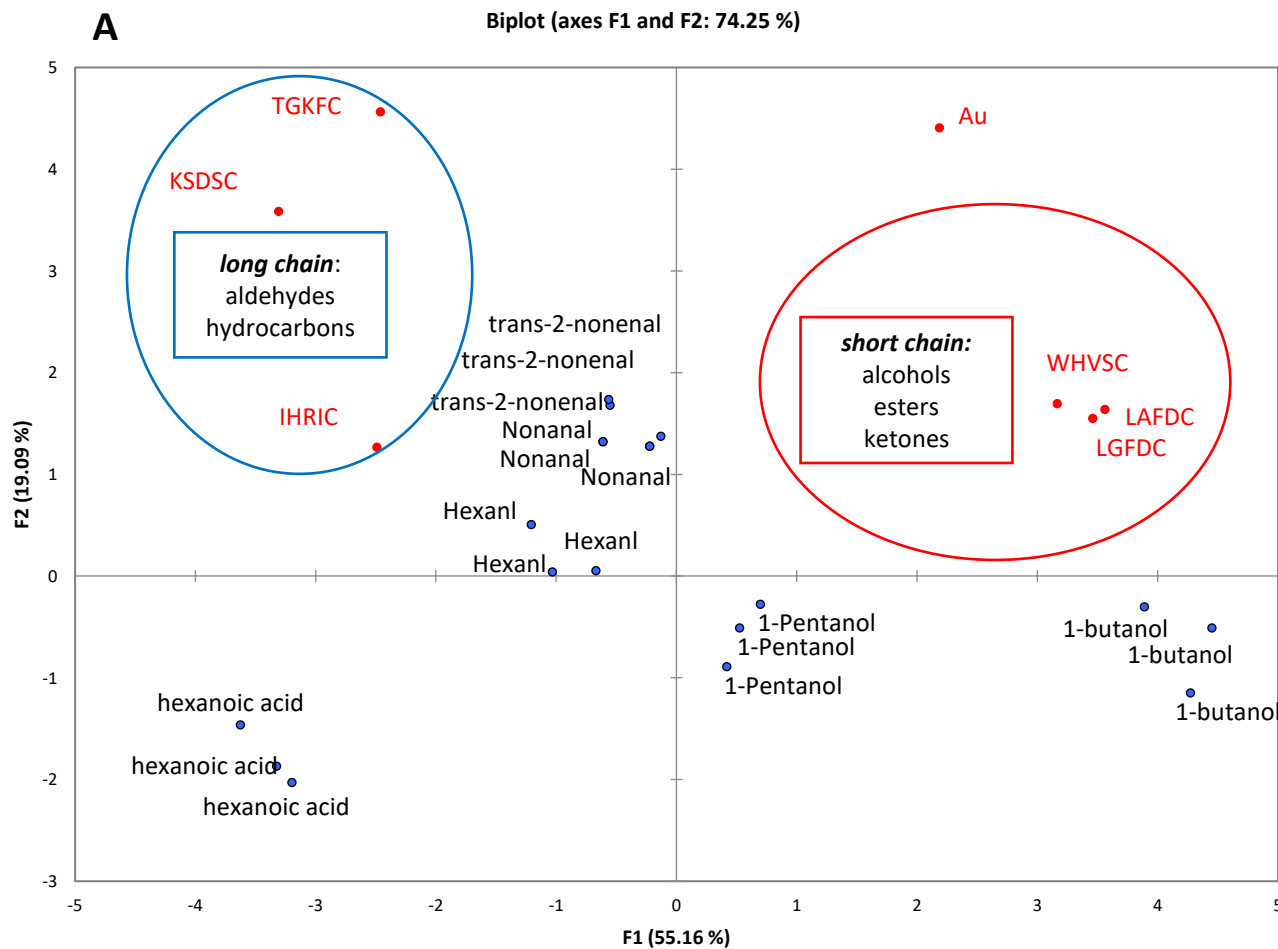

(A) PCA (*loading* and *score* plots) for the discrimination of different VOCs with different penta-peptides; (B) Explain the different chemical structures of VOCs tested: 1-butanol, 1-pentanol, hexanal, trans-2-nonenal, hexanoic acid

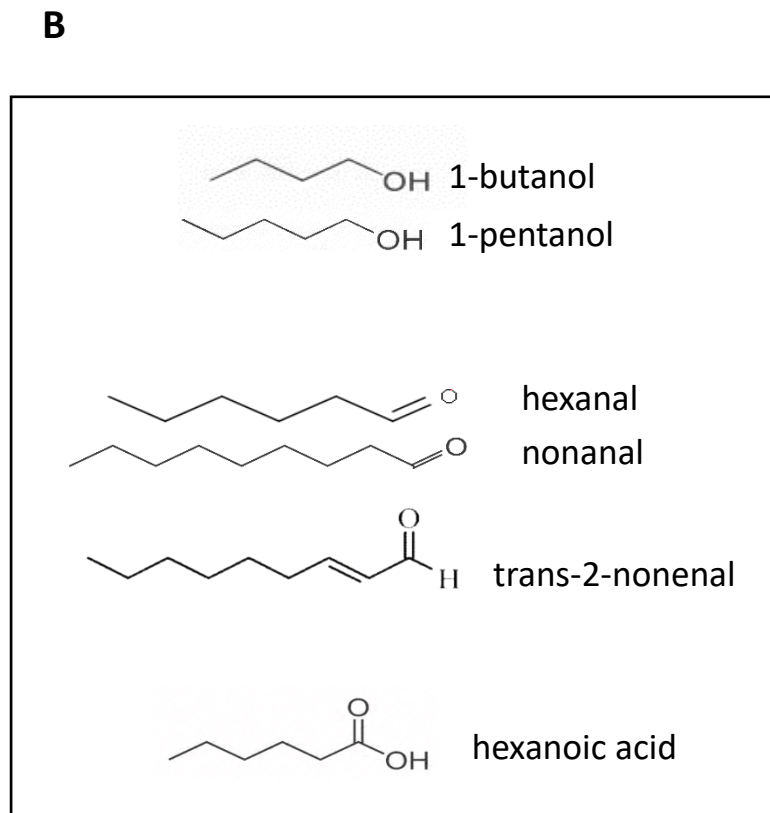
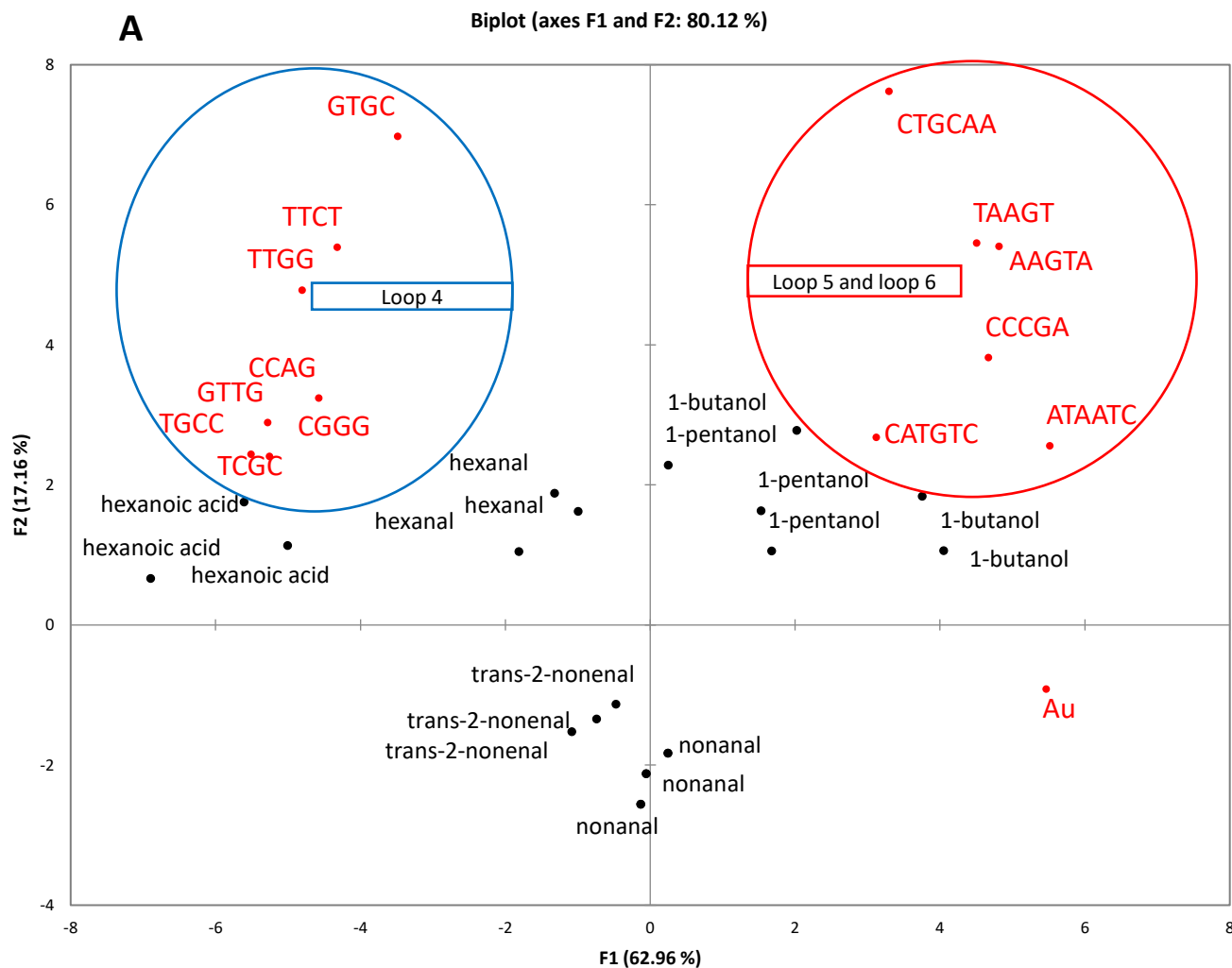

(A) PCA (loading and score plots) for the discrimination of different VOCs with different hpDNA; (B) Explain the different chemical structures of VOCs tested: 1-butanol, 1-pentanol, hexanal, trans-2-nonenal, hexanoic acid



## Agglomerative hierarchical Clustering (AHC) analysis with peptide and hpDNA

Dendrogram

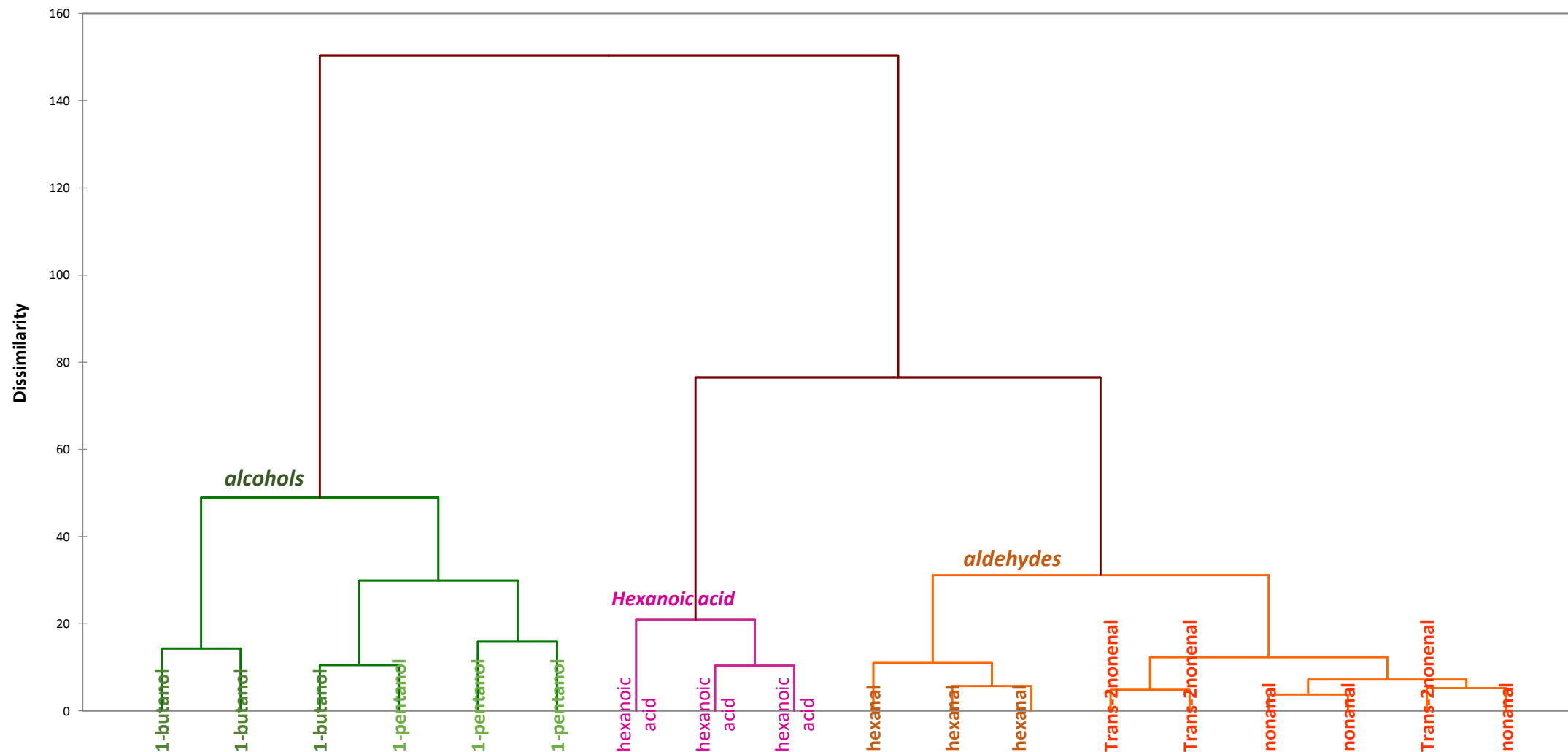

Article

# A Study of Diagnostic Accuracy Using a Chemical Sensor Array and a Machine Learning Technique to Detect Lung Cancer

Chi-Hsiang Huang <sup>1,2</sup>, Chian Zeng <sup>3</sup>, Yi-Chia Wang <sup>1,2</sup>, Hsin-Yi Peng <sup>3</sup>, Chia-Sheng Lin <sup>4</sup>, Che-Jui Chang <sup>3,5</sup>  and Hsiao-Yu Yang <sup>3,6,\*</sup> 



**Figure S1.** Experimental setup for the analysis of alveolar air consisting of a (1) E-nose, (2) computer, (3) three-way valve and (4) Tedlar bag.

Legend: The bags were connected with the necessary fixture, including an airtight PVC tube and a three-way valve for connection to the E-nose.

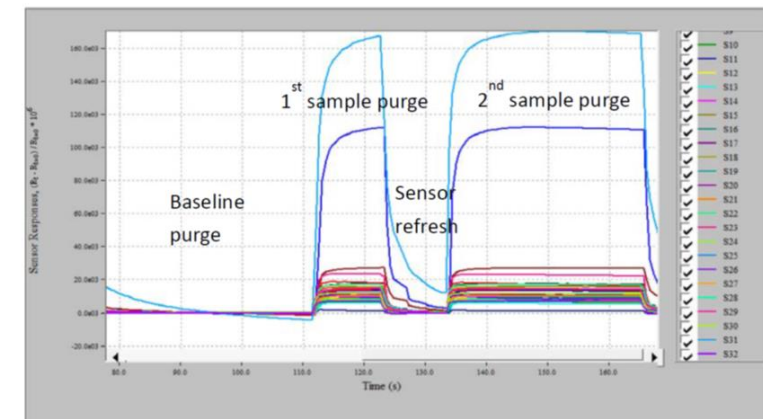
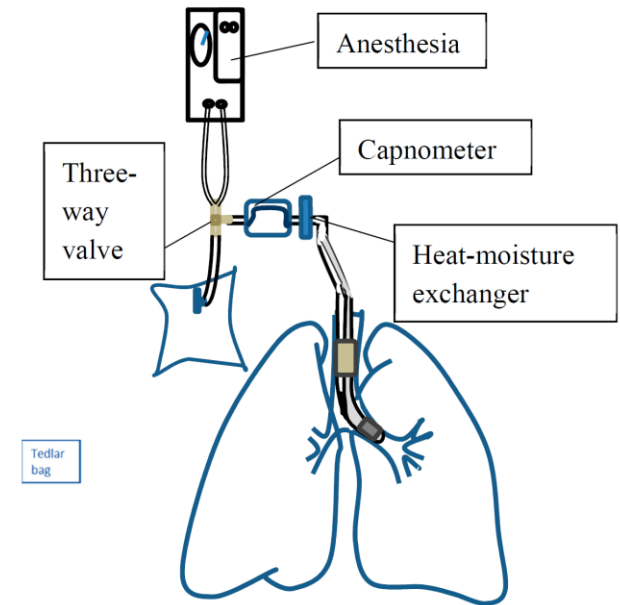

**Figure S2.** Desired waveforms for Cyrano320.

Legend: The setting comprised 10 seconds of a baseline purge and 40 seconds of a sample purge, which was sufficient for most sensors to reach the steady-state, followed by 10 seconds of a wash-out to return to the baseline.

## Early detection of lung cancer with good specificity

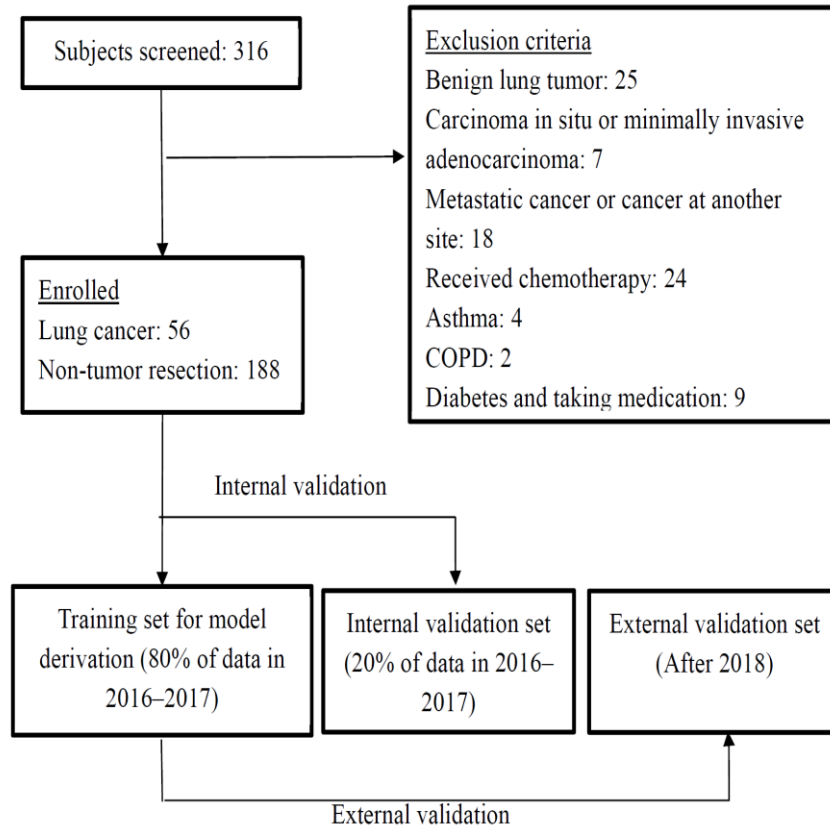

**Figure 2.** Flow diagram depicting the inclusion and exclusion of the study subjects. We employed an independent external validation set and conducted a repeated double cross-validation. The repeated double cross-validation used two nested loops. The inner loop used the study subjects enrolled between 2016 and 2017 as a calibration set for model selection and parameter optimization and were divided into a training set (80%) and an internal validation set (20%). The outer loop used the prediction model established from the calibration set to externally validate the study subjects enrolled in 2018.

Model	Sensitivity	Specificity	PPV	NPV	FP	FN	Accuracy
LDA internal validation	100.0%	88.6%	60.0%	100.0%	12.4%	0.0%	90.2%
LDA external validation	75.0%	96.6%	90.0%	90.3%	3.4%	25.0%	85.4%
SVM internal validation	92.3%	92.9%	85.7%	96.3%	7.1%	7.7%	92.7%
SVM external validation	83.3%	86.2%	71.4%	92.6%	13.8%	16.7%	85.4%

LDA, linear discriminant analysis; SVM, support vector machine; PPV, positive prediction rate; NPV, negative prediction value; FP, false-positive; FN, false-negative.

## Non-invasive Detection of Bladder Tumors Through Volatile Organic Compounds: A Pilot Study with an Electronic Nose

HENDRIK HEERS<sup>1</sup>, JOSEF MAXIMILIAN GUT<sup>1</sup>, AXEL HEGELE<sup>1</sup>, RAINER HOFMANN<sup>1</sup>,  
TOBIAS BOESEL<sup>2</sup>, AKIRA HATTESOHL<sup>2</sup> and ANDREAS REMBERT KOCZULLA<sup>2</sup>

<sup>1</sup>Department of Urology and Paediatric Urology,  
Philipps-Universität Marburg, Marburg, Germany;

<sup>2</sup>Department of Pulmonology, Philipps-Universität Marburg, Marburg, Germany

Urine samples, standard protocol for  
bladder tumour diagnosis, cystoscopy

Table I. Patient demographics.

	Tumor	Control
Number of individuals	30	30
Mean age [years]	71.3	56.4
Age range [years]	49-86	21-85
Gender (male:female)	24:6	21:9
Smokers	6	6
Former smokers	8	1
Microscopic haematuria	17	7

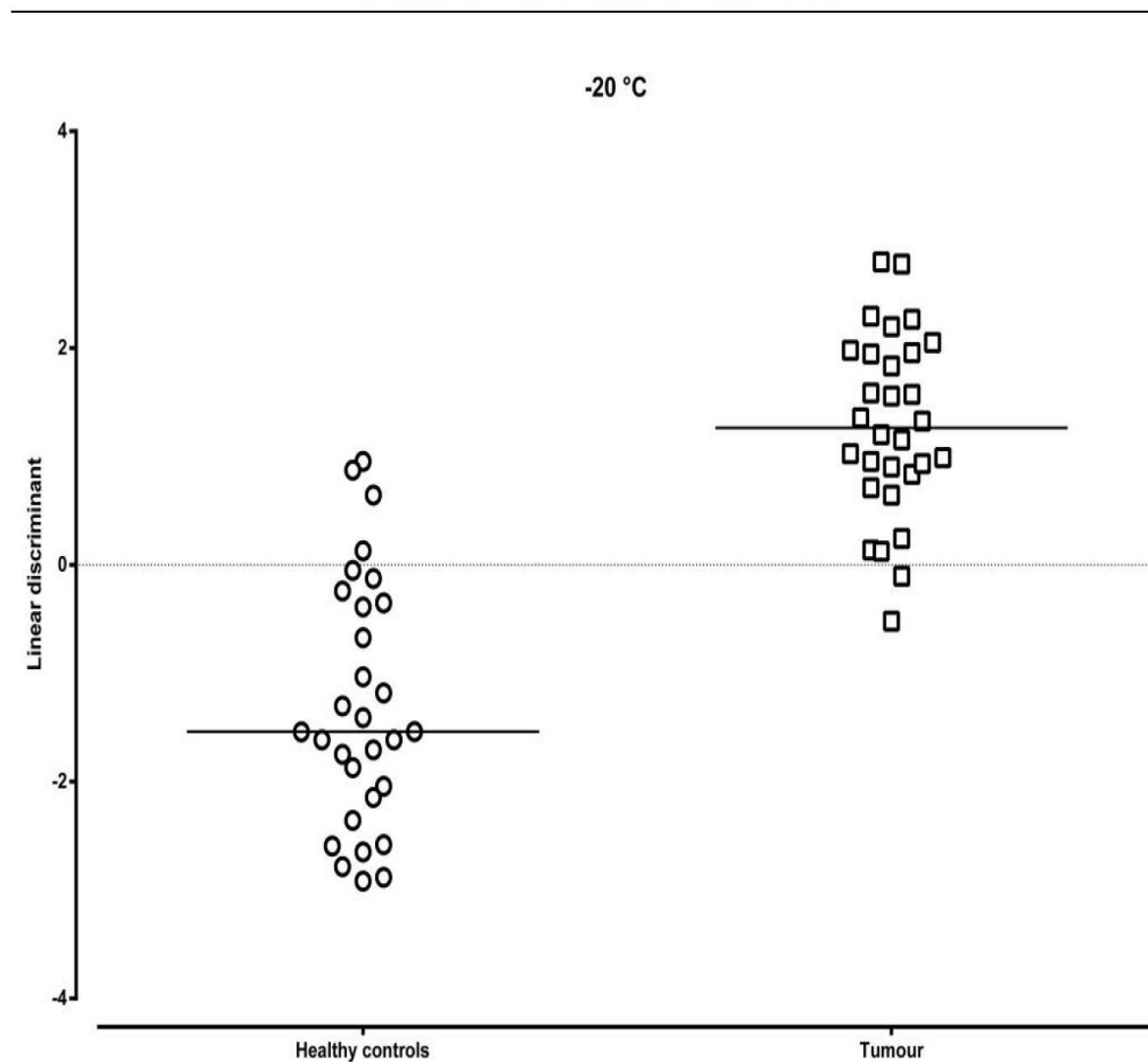



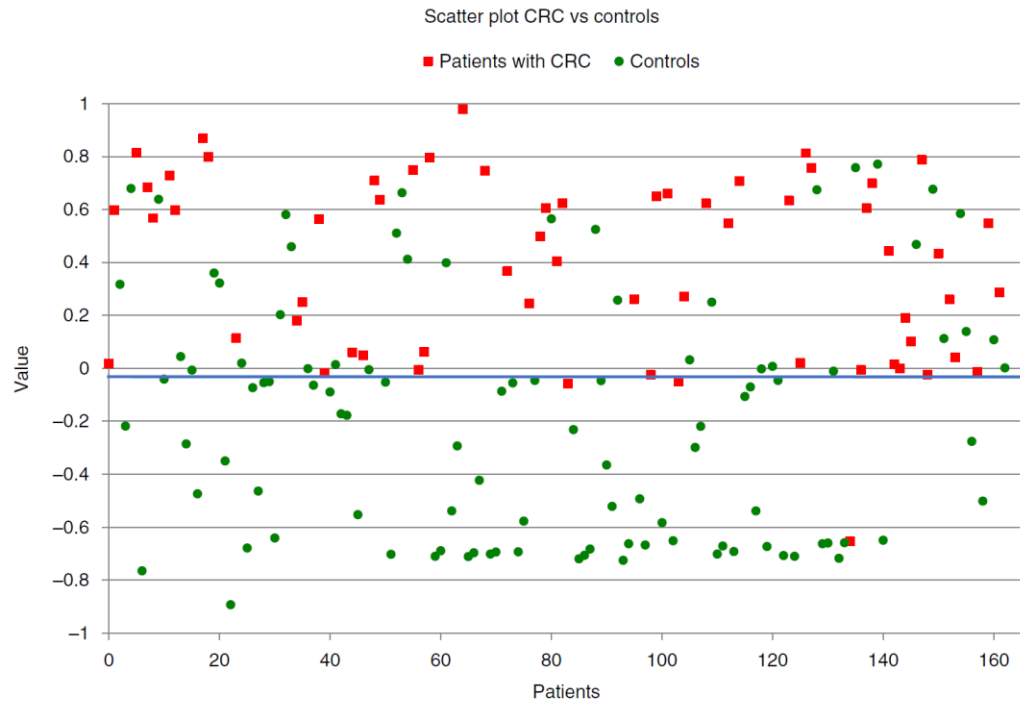

Figure 1. LDA for samples stored at  $-20^{\circ}\text{C}$ .

# Volatile organic compounds in breath can serve as a non-invasive diagnostic biomarker for the detection of advanced adenomas and colorectal cancer

Kelly E. van Keulen<sup>1</sup>  | Maud E. Jansen<sup>2,3</sup> | Ruud W. M. Schrauwen<sup>4</sup> |  
Jeroen J. Kolkman<sup>2,3</sup>  | Peter D. Siersema<sup>1</sup> 



**FIGURE 1** Electronic nose used in the study; the Aeonose (The eNose Company). Patients inhale through a carbon filter to prevent the entry of nonfiltered environmental air and breathe into the device through a disposable mouthpiece while wearing a nose clip

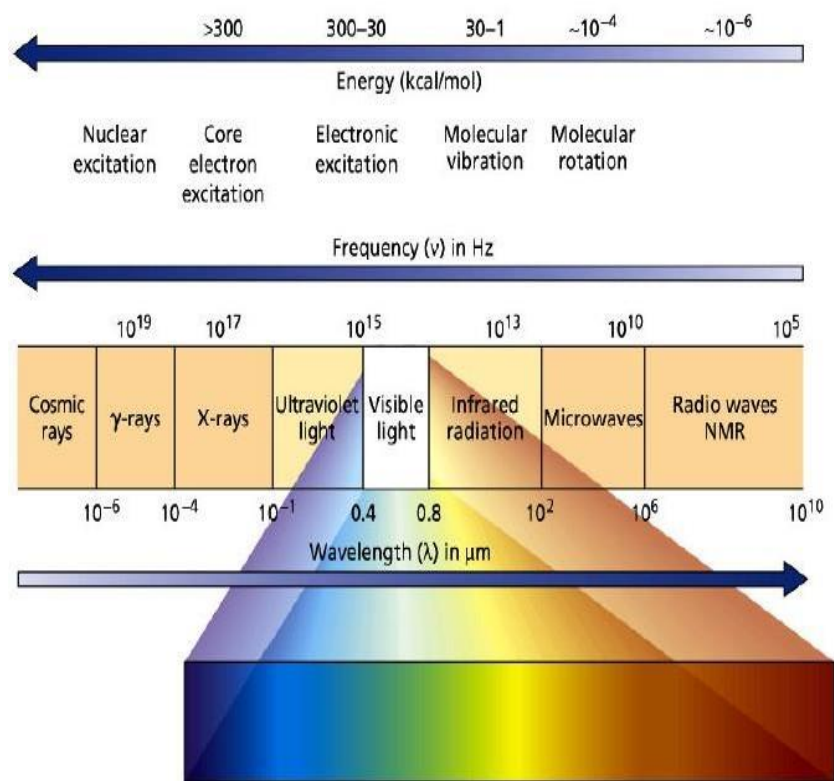

## INTRODUCTION OF IR SPECTROSCOPY

- Infrared spectroscopy is an important analytical technique for determining the structure of both inorganic & organic compounds. It is also known as vibrational spectroscopy
- IR radiations lies in the wavelength range of **0.7 - 400  $\mu\text{m}$** .
- IR spectroscopy is based upon selective absorption of IR radiations by the molecule which induces vibration of the molecules of the compound.
- IR instruments are of 2 types namely, dispersive instruments (spectrophotometers) and Fourier transform IR instrument.
- The radiation sources used are incandescent lamp, Nernst glower etc., and the detectors used are thermal and photon detectors.

## NATURE OF IR SPECTRA

- IR spectrum is a graph of band intensities on ordinate versus position of band on abscissa.
- Band intensities can be given in terms of transmittance(T) or absorbance(A).
- Position of band can be expressed in terms of wave number ( $\bar{\nu}$ ) or wavelength( $\lambda$ ).
- In IR spectra, wave numbers ( $\bar{\nu}$ ) are used instead of wavelength ( $\lambda$ ) for mentioning the characteristic peak as this unit has advantage of being linear with energy of radiation (E) .

$$E = h c / \lambda \quad \text{or, } E = h c \bar{\nu}$$

[  $\bar{\nu} = 1/\lambda$ ,  $c$  = velocity of light,  $h$  = Planck's constant ]

## PRINCIPLE OF IR SPECTROSCOPY

- When the energy in the form of IR is applied and if the **applied IR frequency = Natural frequency of vibration**, the absorption of IR takes place and a peak is observed.
- Molecules are excited to the higher energy state from the ground state when they absorb IR radiation.
- When a compound is exposed to IR radiation, it selectively absorbs the radiations resulting in vibration of the molecules of the compound, giving rise to closely packed absorption bands, called as **IR absorption spectrum**.
- The bands correspond to the characteristic **functional groups and the bonds** present in a chemical substance. Thus, an IR spectrum of a compound is considered as the fingerprint for its chemical identification.



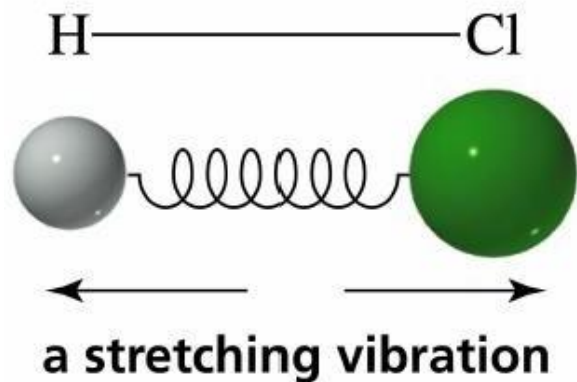

CHANGE IN DIPOLAR MOMENT OF THE MOLECULES MUST OCCUR!

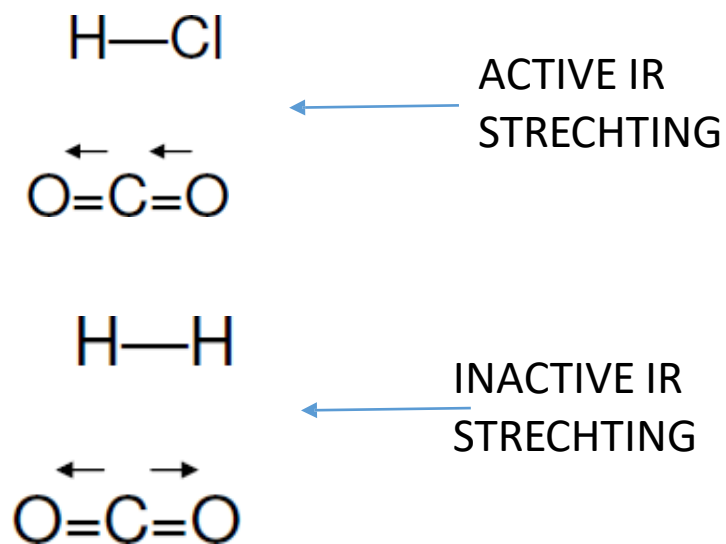

## CRITERIA FOR A COMPOUND TO ABSORB IR RADIATION

### 1. Correct wave length of incident radiation

- ❑ A molecule absorbs radiation only when the frequency of the incident radiation is equivalent to the natural frequency of vibration of the part of the molecule.
- ❑ After absorption of the correct wave length of radiations, the molecule vibrates at increased amplitude due to absorbed IR energy.
- ❑ Example: HCl has natural vibrational frequency of  $8.7 \times 10^{13}/s$  ( $2890 \text{ cm}^{-1}$ ). When HCl sample is exposed to IR radiations, only the radiations of frequency  $8.7 \times 10^{13}/s$  are absorbed and remaining are transmitted.

# Infrared Spectroscopy

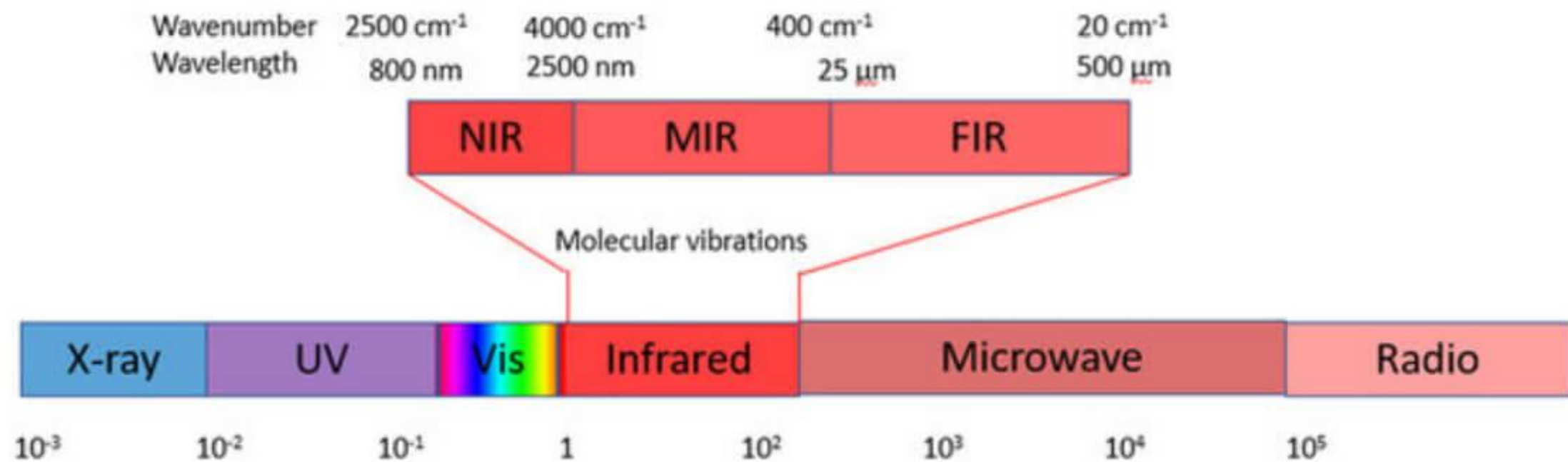

## PEAK POSITION

$$\tilde{\nu} = \frac{1}{2\pi c} \sqrt{\frac{k}{m^*}}$$

k = bond strength

$$m^* = m_A m_B / (m_A + m_B)$$

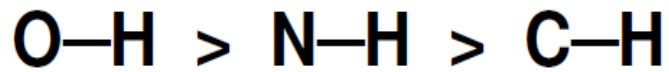

BOND STRENGTH

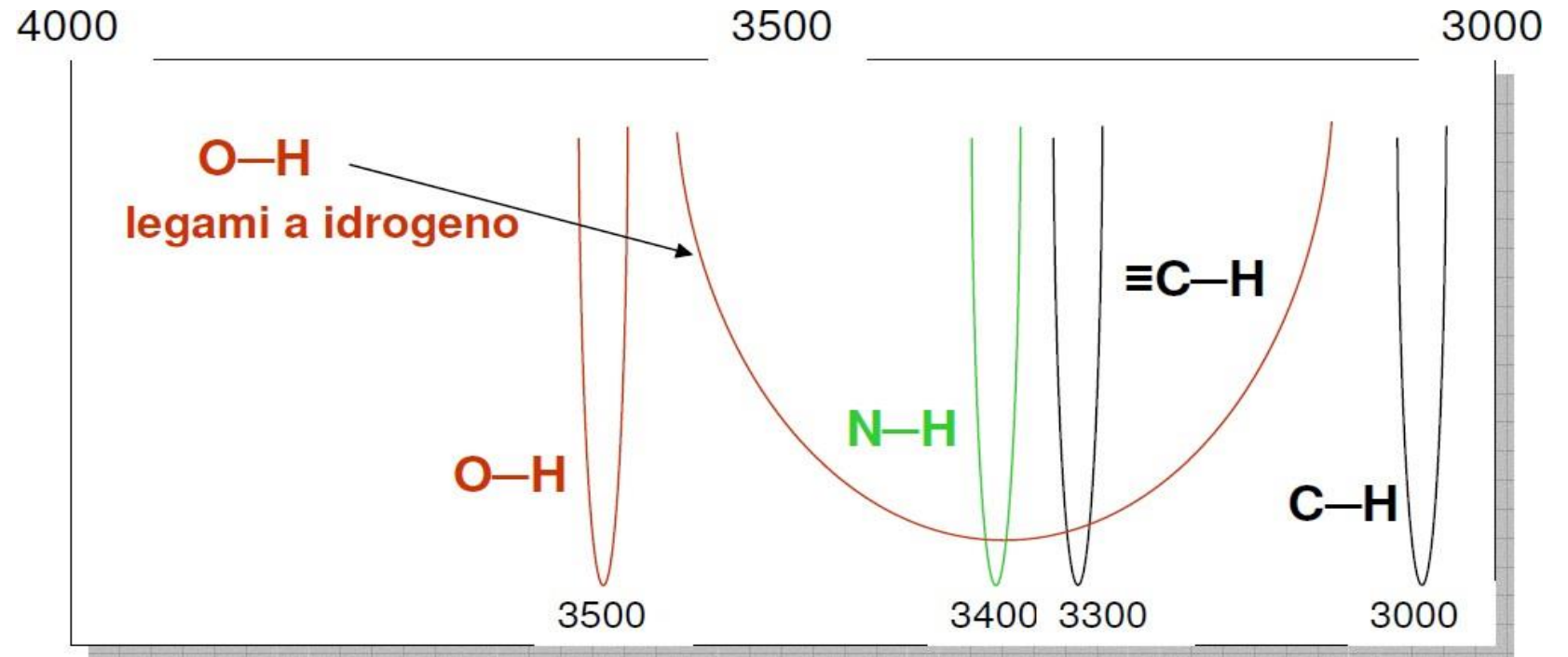
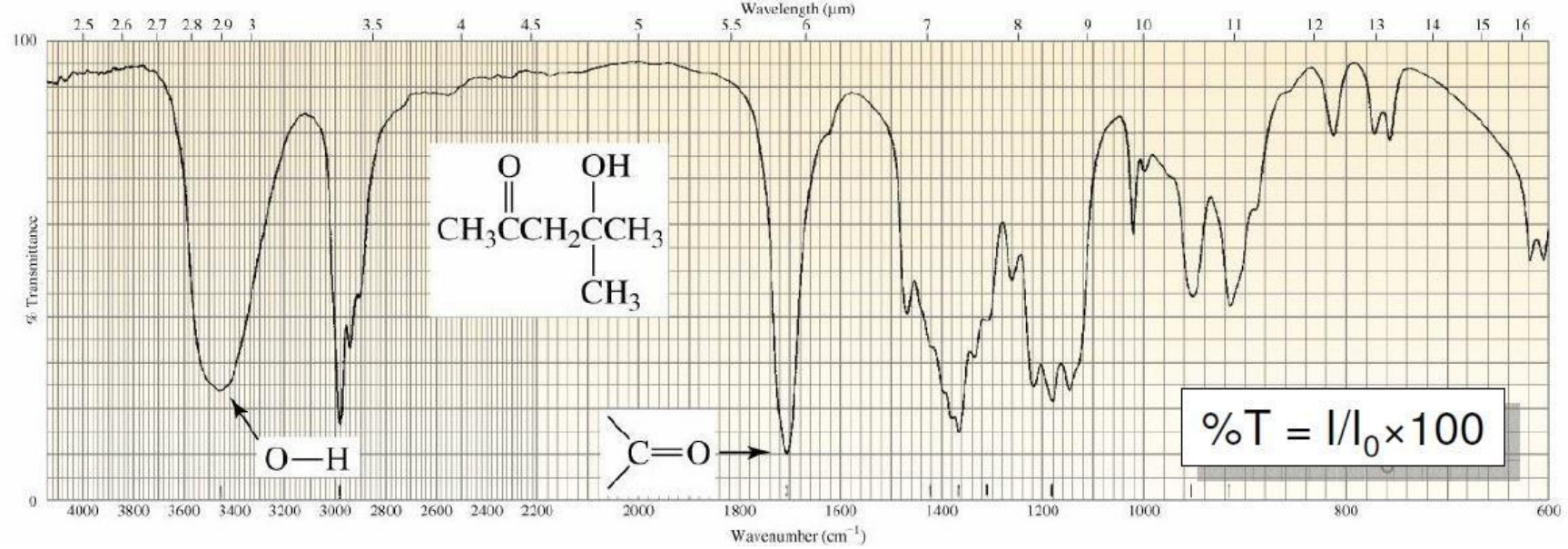

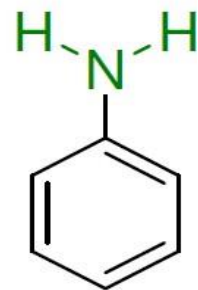
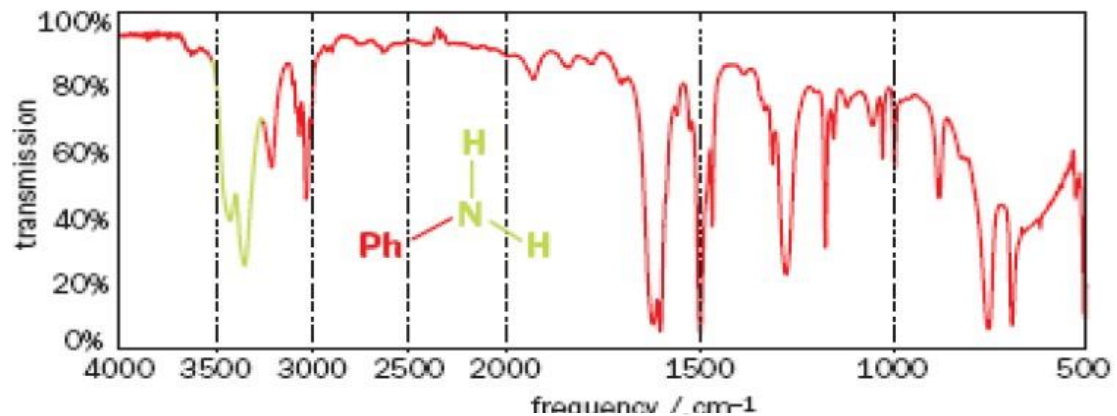

SIMMETRIC AND ASIMMETRIC  
STRETCHING

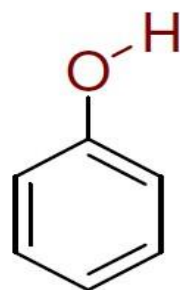
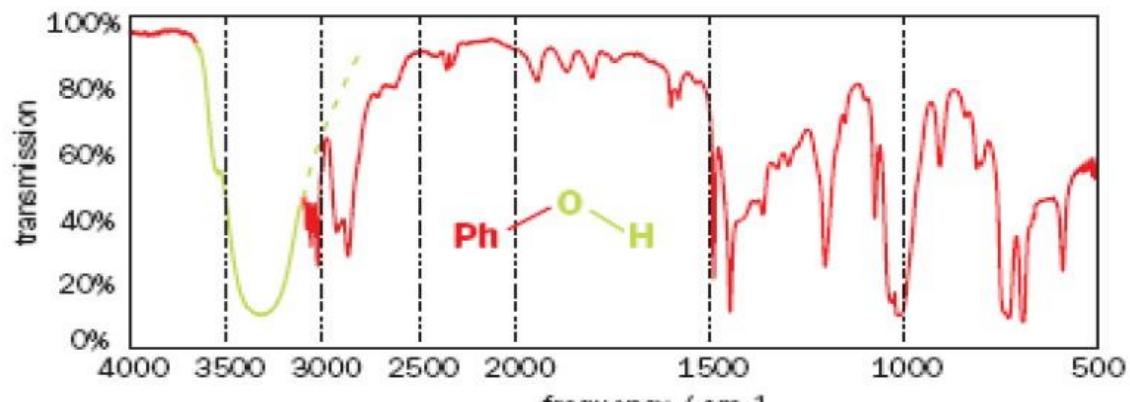

HYDROGEN BONDS

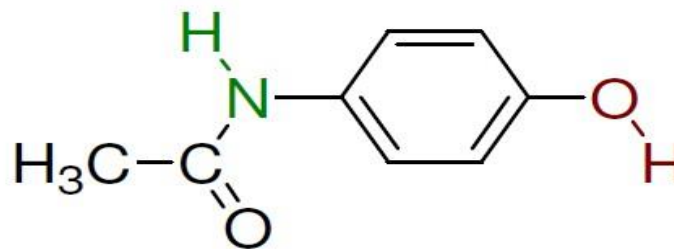
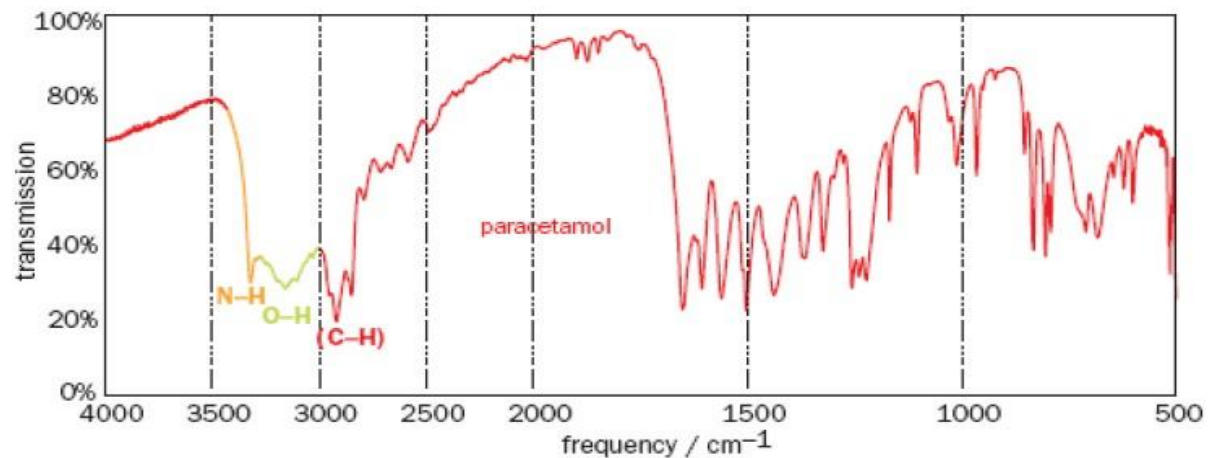

# SPETTRO MIR!

# ANALYTICAL CHEMISTRY - INFRARED SPECTROSCOPY

Commonly referred to as IR spectroscopy, this technique allows chemists to identify characteristic groups of atoms (functional groups) present in molecules.

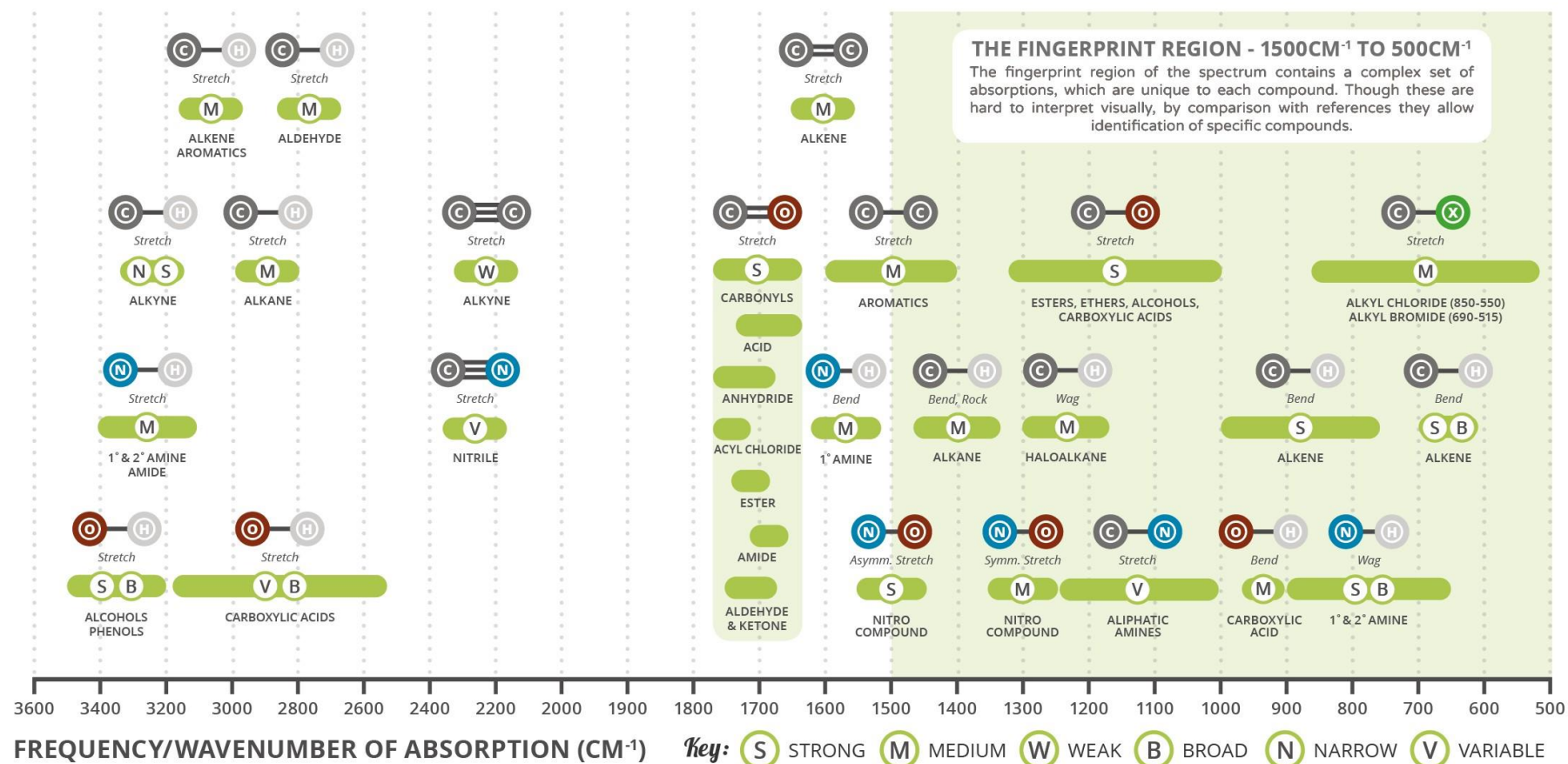

Infrared frequencies make up a portion of the electromagnetic spectrum. If a range of infrared frequencies are shone through an organic compound, some of the frequencies are absorbed by the chemical bonds within the compound. Different chemical bonds absorb different frequencies of infrared radiation. There are a number of characteristic absorptions which allow functional groups (the parts of a compound which give it its particular reactivity) to be identified. This graphic shows a number of these absorptions.



# ELECTRO-MAGNETIC SPECTRUM

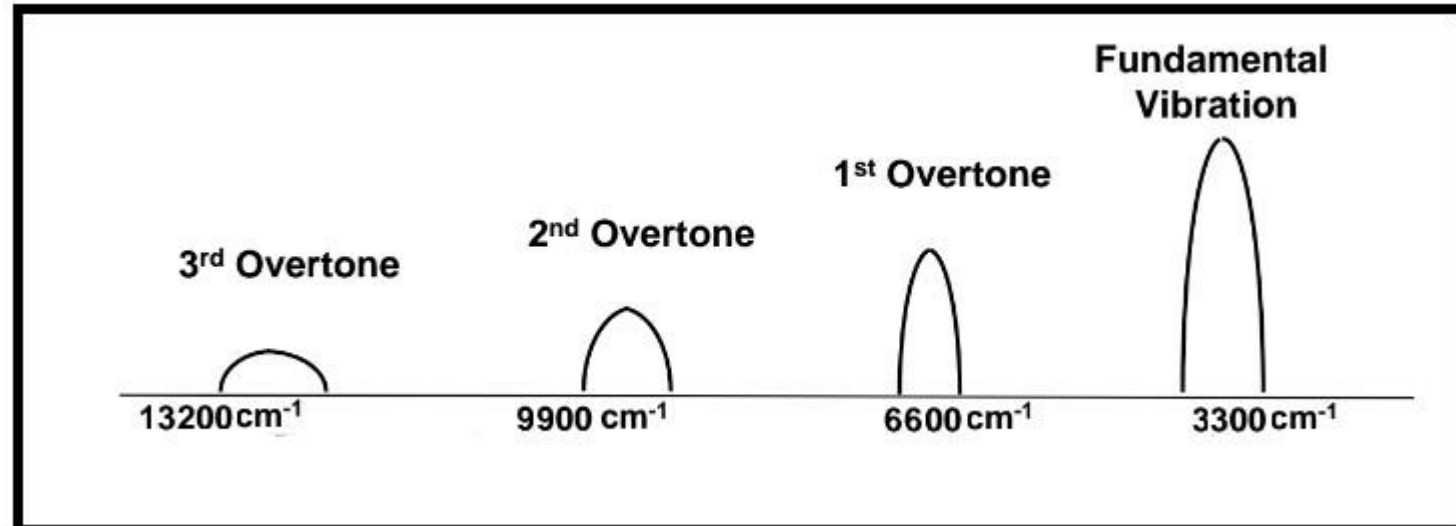
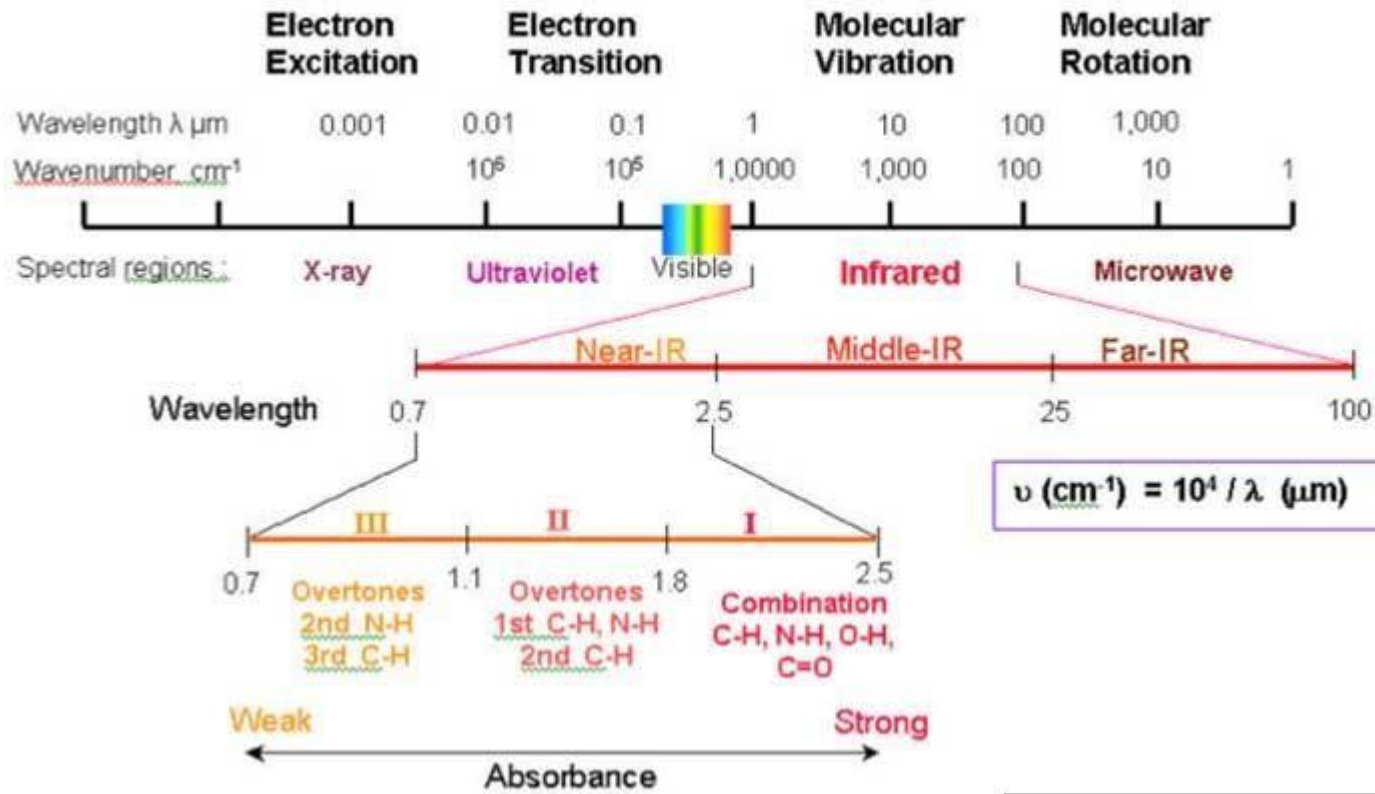

# SPETTROMETRI IR E FTIR (O FT-NIR)

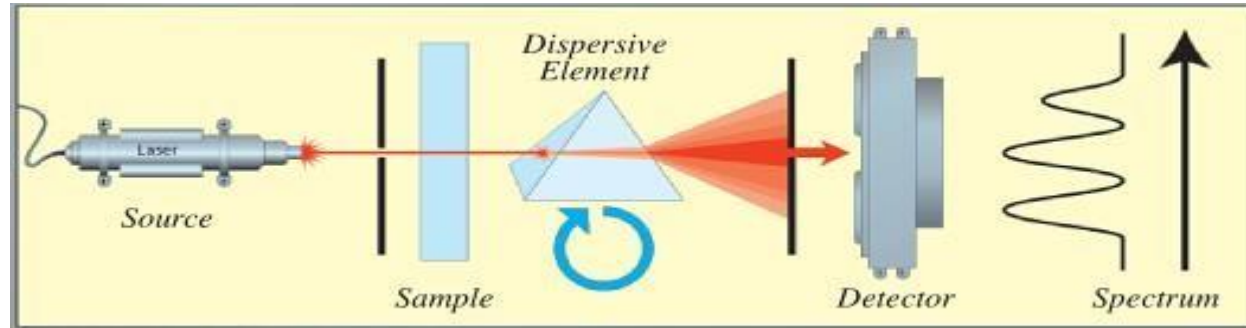

## FT-IR

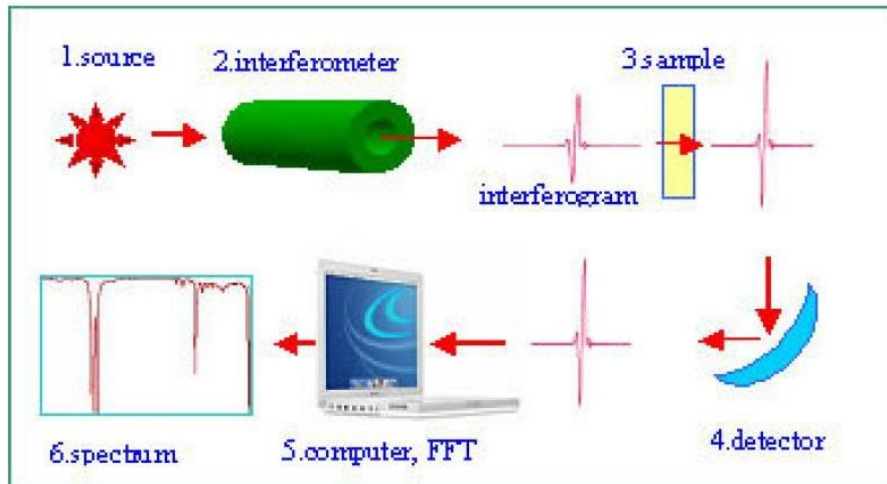

# MICHELSON INTERFEROMETER

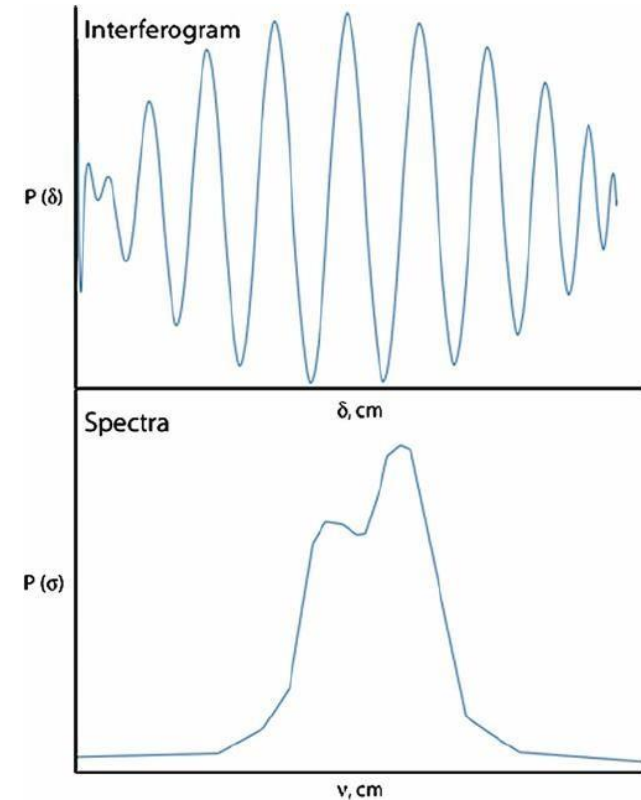
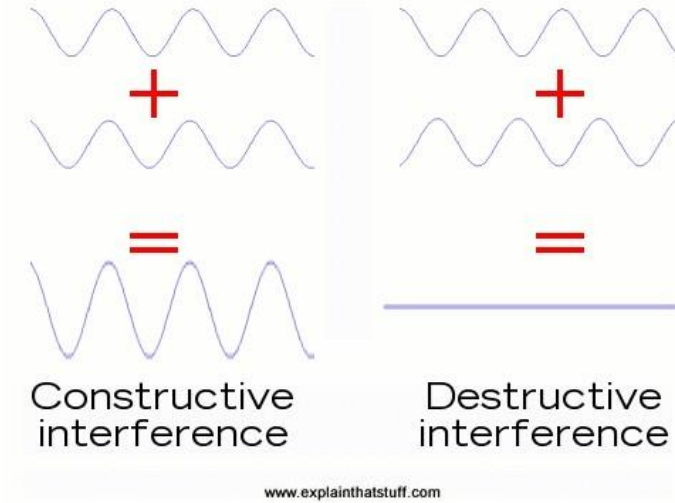
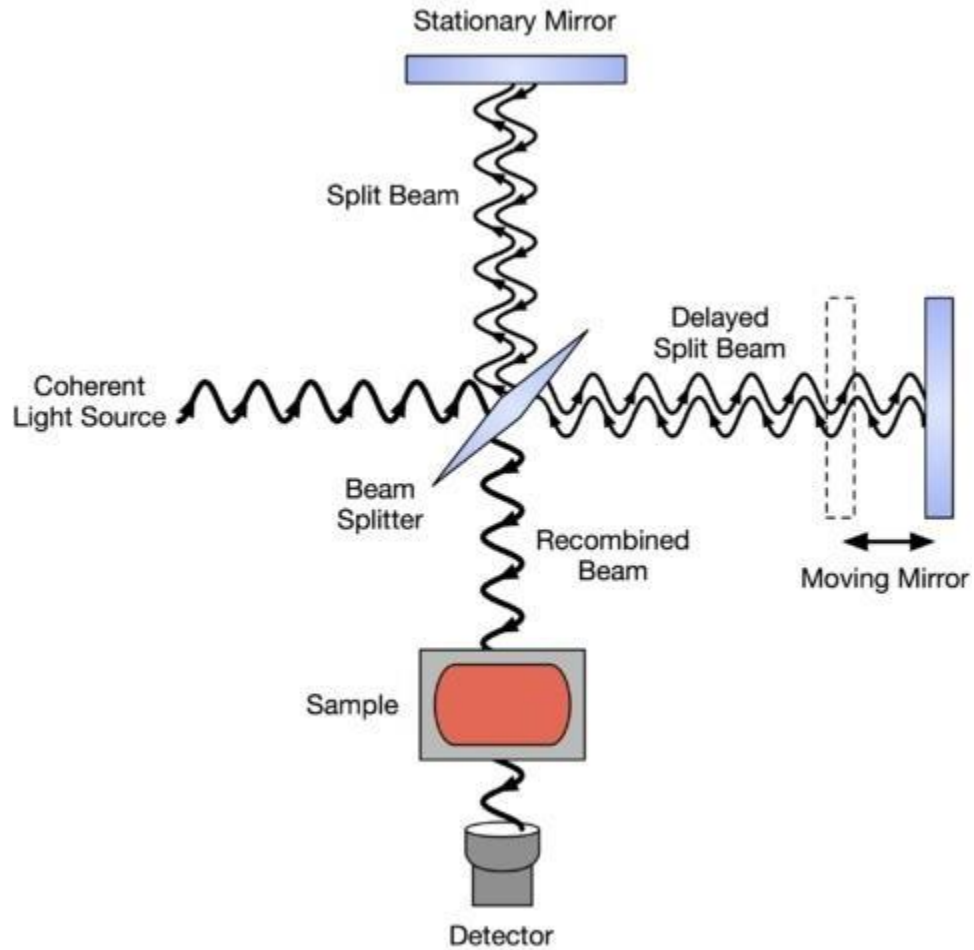



① monochromatic radiation of wavelength  $\lambda$

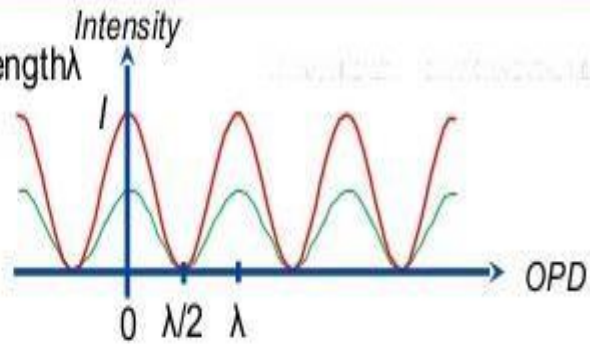

② two wavelengths radiation

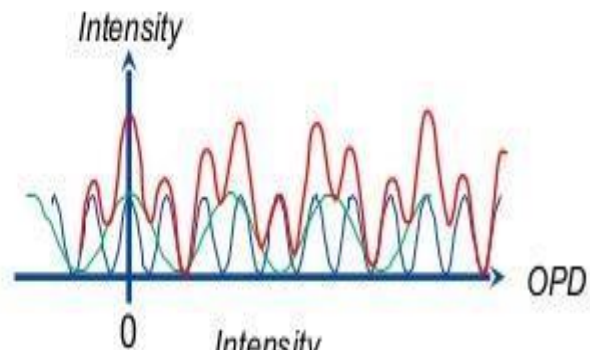
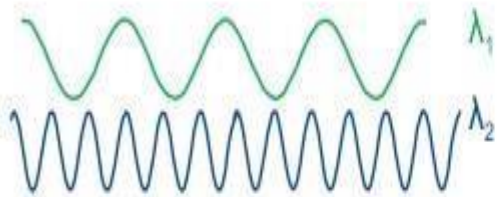

③ multiple wavelengths

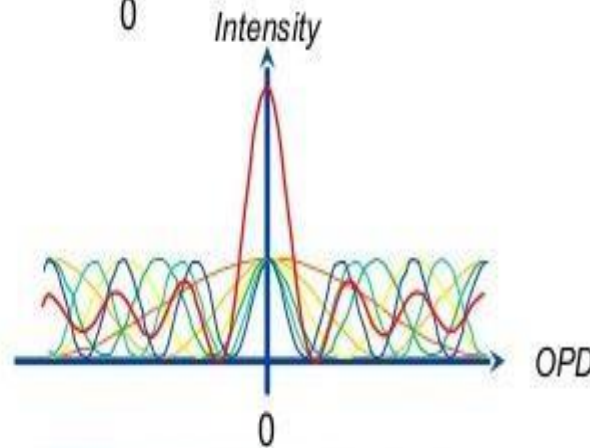
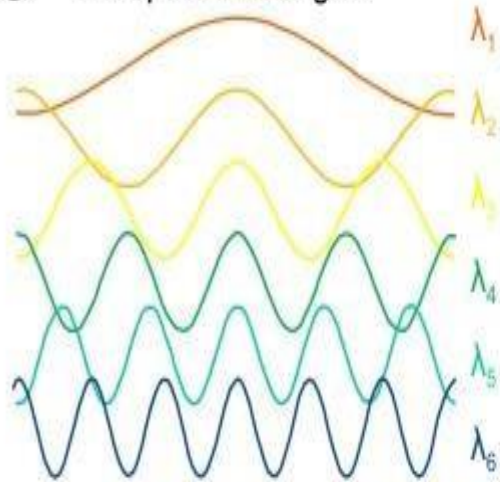

intensity is strongest at 0 optical path difference

continuous wavelength radiation

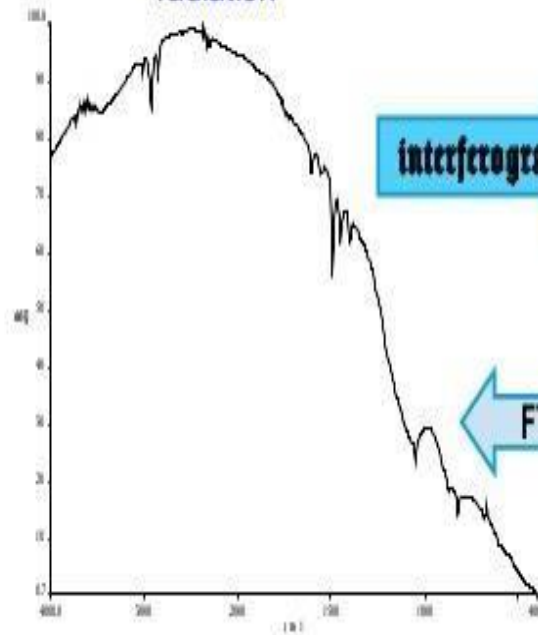

interferogram

FT

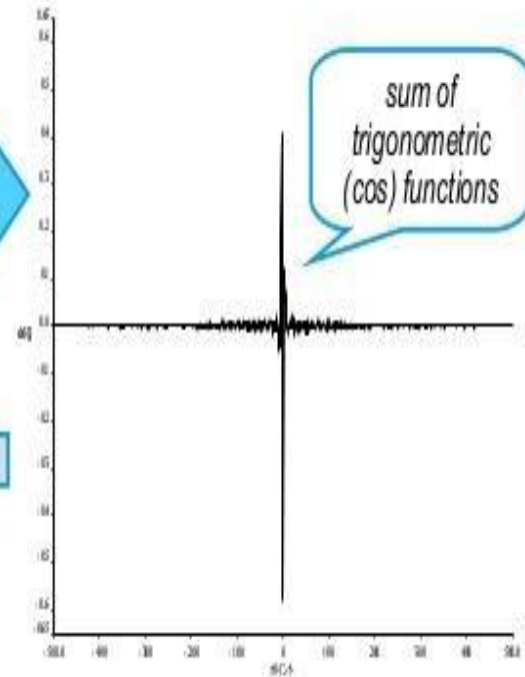

### 1. Attenuated Total Reflection

- The beam is directed onto optical dense crystal , *internal reflectance* create waves that extend to the sample in contact with crystal surface.

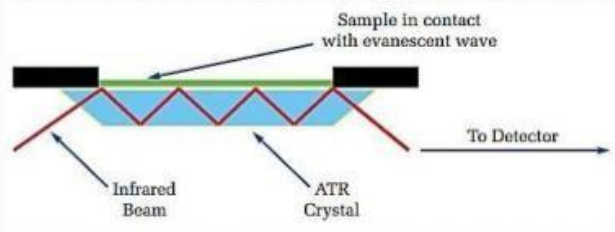

50



## UNTREATED SAMPLES IN FTNIR



# Analyze milk using the Pearl FTIR



#SpectroscopyGuides



# Quantitative analysis of :

- **Oleic acid**
- **Linoleic acid**
- **Saturated Fatty acids (SFA)**
- **Monounsaturated fatty acids (MUFA)**
- **Polyunsaturated fatty acids (PUFA)**
- **Peroxides value**

**86** samples of extravirgin olive oil from Abruzzo, Marche e Puglia (2006 e 2007)

- Chemical analysis (FA, PV, spectrophotometric indices)
- Determination of fatty acids (GC)



FTIR spectra acquired with Tensor 27™ FTIR (Bruker Optics, Milan, Italy), interferometer Rocksolid™ and detector DigiTect™ with ATR. ATR (Specac Inc., Woodstock, GA, USA) had ZnSe crystal.

Spectra (32 scans/sample) acquired in the 600 to 4000  $\text{cm}^{-1}$  range with a resolution of 4  $\text{cm}^{-1}$ .



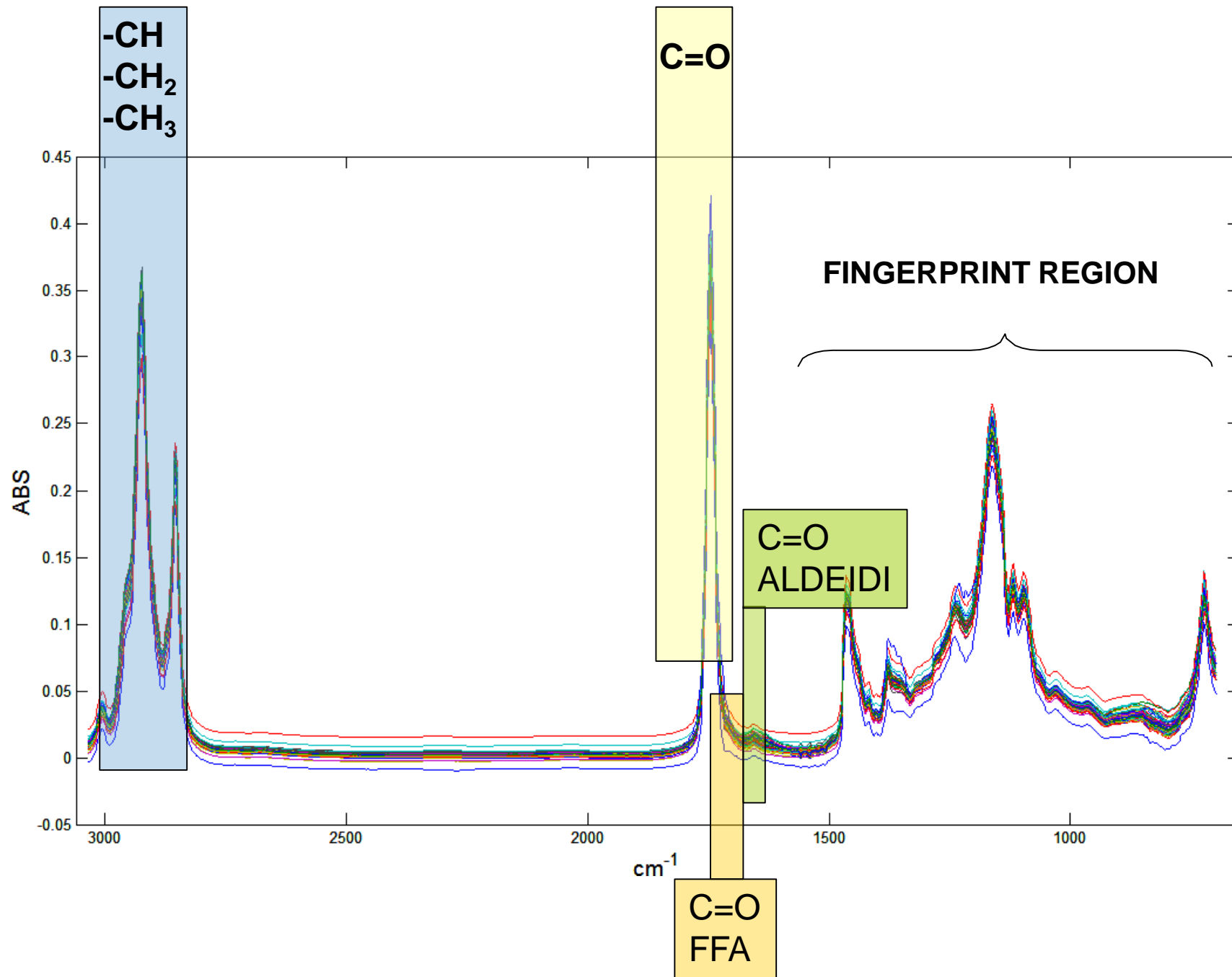

## Data processing and calibration models

Data exported as ASCII file with OPUS 6.0 software and processed with a PLS routine (Partial least squares) run on Matlab (Mathworks Inc., Natick, MA, USA).

For each parameter a PLS model has been built starting from a training set and taking as true value the data obtained using GC or chemical analysis

Spectra initially processed entirely have been reduced using a “moving-windows” strategy with a Matlab routine.

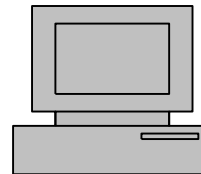
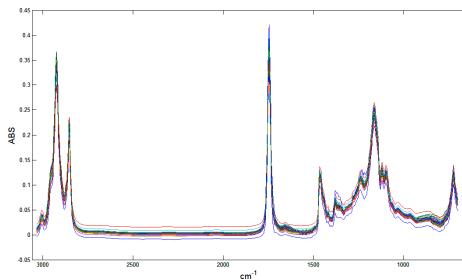

Property	MUFA	PUFA	SFA
<i>Calibration</i>			
Spectral range (cm <sup>-1</sup> )	700-3033	700-3033	700-3033
Linear range (% in VOO)	64 - 81	13 - 20	6 - 16
Number of factors (LVs)	14	15	13
Number of training samples (N)	61	61	61
PRESS <sup>a</sup>	10.59	2.52	6.11
Root mean square deviation (RMSD, %)	0.42	0.20	0.32
Relative error in calibration (REC %)	0.56	2.23	1.95
r <sup>2</sup>	0.9883	0.9941	0.9557
Selectivity	0.1734	0.1988	0.1378
Sensitivity (SEN)	0.0009	0.0015	0.0020
Analytical sensitivity, [γ = (SEN/σ <sub>w</sub> )]	0.17	2.07	0.32
Minimum concentration difference	6.0	0.48	3.17
Limit of detection (LOD, % in VOO)	3	0.28	1.3
Limit of quantification (LOQ, % in VOO)	10	0.94	4.5
<i>Validation</i>			
Number of validations samples	25	25	25
Recovery rates (%)	100	103	98
Relative error in Prediction, (REP, %)	1	4	6
r <sup>2</sup>	0.8884	0.9816	0.7099
y <sub>o</sub>	5 ± 5	0.4 ± 0.2	5 ± 1
Slope	0.93 ± 0.07	0.98 ± 0.03	0.7 ± 0.1

## Results I: oleic and linoleic acid

Property	Oleic Acid	Linoleic Acid
<i>Calibration</i>		
Spectral range (cm <sup>-1</sup> )	700-3033	700-3033
Linear range (% in VOO)	62 - 80	5 - 15
Number of factors (LVs)	14	13
Number of training samples ( <i>N</i> )	61	61
PRESS <sup>a</sup>	10.88	9.33
Root mean square deviation (RMSD)	0.42	0.39
Relative error in calibration (REC %)	0.51	4.64
$r^2$	0.9886	0.9773
Selectivity	0.1785	0.1988
Sensitivity (SEN)	0.0009	0.0016
Analytical sensitivity, [ $\gamma = (SEN/\sigma_o)$ ]	0.18	1.17
Minimum difference (%)	5.6	0.9
Limit of detection (LOD, % in VOO)	3	0.5
Limit of quantification (LOQ, % in VOO)	10	1.7
<i>Validation</i>		
Number of validation samples	25	25
Recovery rates (%)	100	98
Relative error in Prediction (REP %)	1	7
$r^2$	0.9232	0.9444
$y_o$	4 ± 4	0.1 ± 0.4
Slope	0.94 ± 0.06	0.96 ± 0.05

## Results II: MUFA, PUFA, SFA

Property	MUFA	PUFA	SFA
<i>Calibration</i>			
Spectral range (cm <sup>-1</sup> )	700-3033	700-3033	700-3033
Linear range (% in VOO)	64 - 81	13 - 20	6 - 16
Number of factors (LVs)	14	15	13
Number of training samples (N)	61	61	61
PRESS <sup>a</sup>	10.59	2.52	6.11
Root mean square deviation (RMSD, %)	0.42	0.20	0.32
Relative error in calibration (REC %)	0.56	2.23	1.95
r <sup>2</sup>	0.9883	0.9941	0.9557
Selectivity	0.1734	0.1988	0.1378
Sensitivity (SEN)	0.0009	0.0015	0.0020
Analytical sensitivity, [ $\gamma = (\text{SEN}/\sigma_0)$ ]	0.17	2.07	0.32
Minimum concentration difference	6.0	0.48	3.17
Limit of detection (LOD, % in VOO)	3	0.28	1.3
Limit of quantification (LOQ, % in VOO)	10	0.94	4.5
<i>Validation</i>			
Number of validations samples	25	25	25
Recovery rates (%)	100	103	98
Relative error in Prediction, (REP, %)	1	4	6
r <sup>2</sup>	0.8884	0.9816	0.7099
y <sub>0</sub>	5 ± 5	0.4 ± 0.2	5 ± 1
Slope	0.93 ± 0.07	0.98 ± 0.03	0.7 ± 0.1

## Results III: PV

Property	D°	D'	D''
Spectral range (cm <sup>-1</sup> )	4000-700	4000-700	4000-700
Calibration range (meqO <sub>2</sub> kg <sup>-1</sup> oil)	5.7-15.7	5.7-15.7	5.7-15.7
Number of factors (LV)	5	10	7
Number of training samples	23	24	24
PRESS <sup>a</sup> (unidades)	174.66	152.35	191.32
Root mean square deviation, RMSD (unidades)	1.4302	0.6933	0.9482
Relative error in calibration, REC (%)	15.6	7.2	9.9
r <sup>2</sup>	0.8040	0.9759	0.9446
Selectivity	1.0	0.35	0.55
Sensitivity (SEN)	0.0044	0.0001	0.0001
Analytical sensitivity, [ $\gamma = (\text{SEN}/\sigma_o)$ ]	1.2	1.1	1.1
Minimum concentration difference (unidades)	0.8	0.9	0.9
Limit of detection (LOD) (unidades)	3.1	1.0	1.6
Limit of quantification (LOQ) (unidades)	10.3	3.4	5.2
Number of validations samples	10	10	10
Recovery rates (%)	74.7	97.7	96.0
Relative error in Prediction, REP (%)	23.7	13.6	12.2



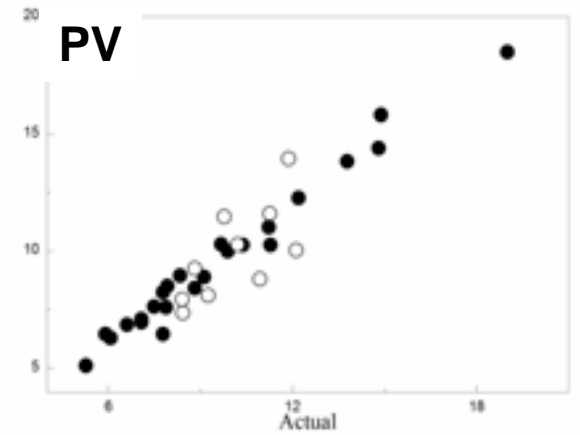
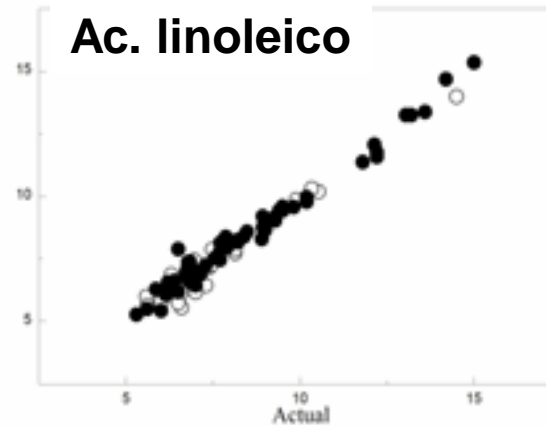
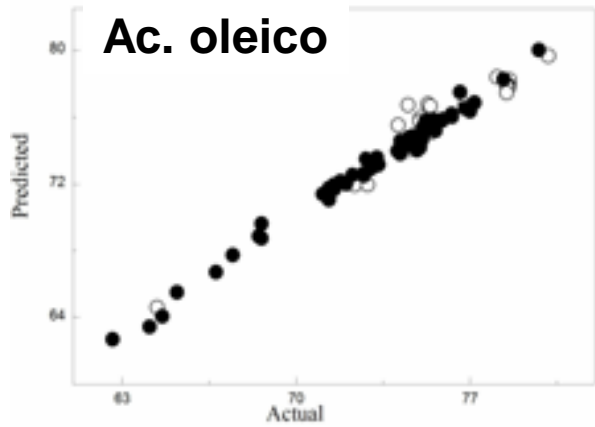
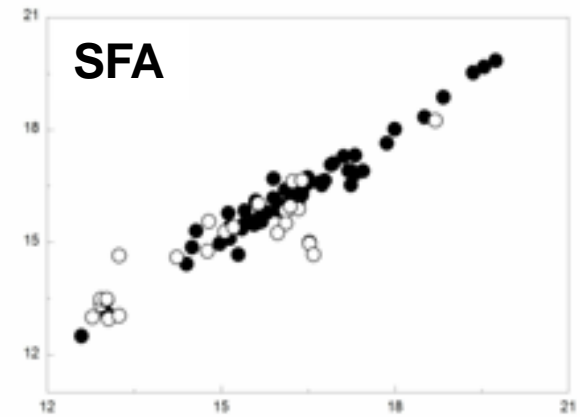
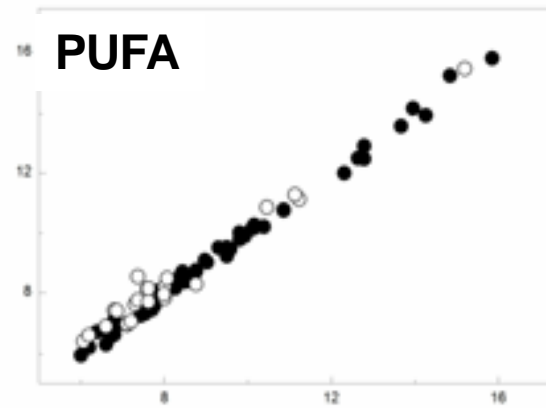
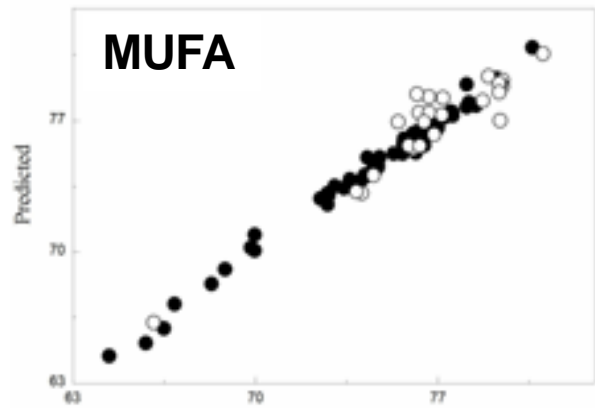

calibration set (●) and trainingset (○)



# Spectrochemical differentiation of meningioma tumours based on attenuated total reflection Fourier-transform infrared (ATR-FTIR) spectroscopy

Taha Lilo<sup>1,2</sup> · Camilo L. M. Morais<sup>2</sup> · Katherine M. Ashton<sup>3</sup> · Ana Pardilho<sup>1</sup> · Charles Davis<sup>2</sup> · Timothy P. Dawson<sup>3</sup> · Nihal Gurusinghe<sup>1</sup> · Francis L. Martin<sup>2</sup>

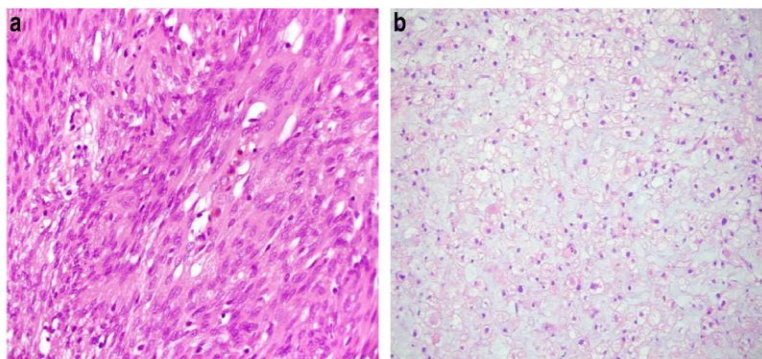
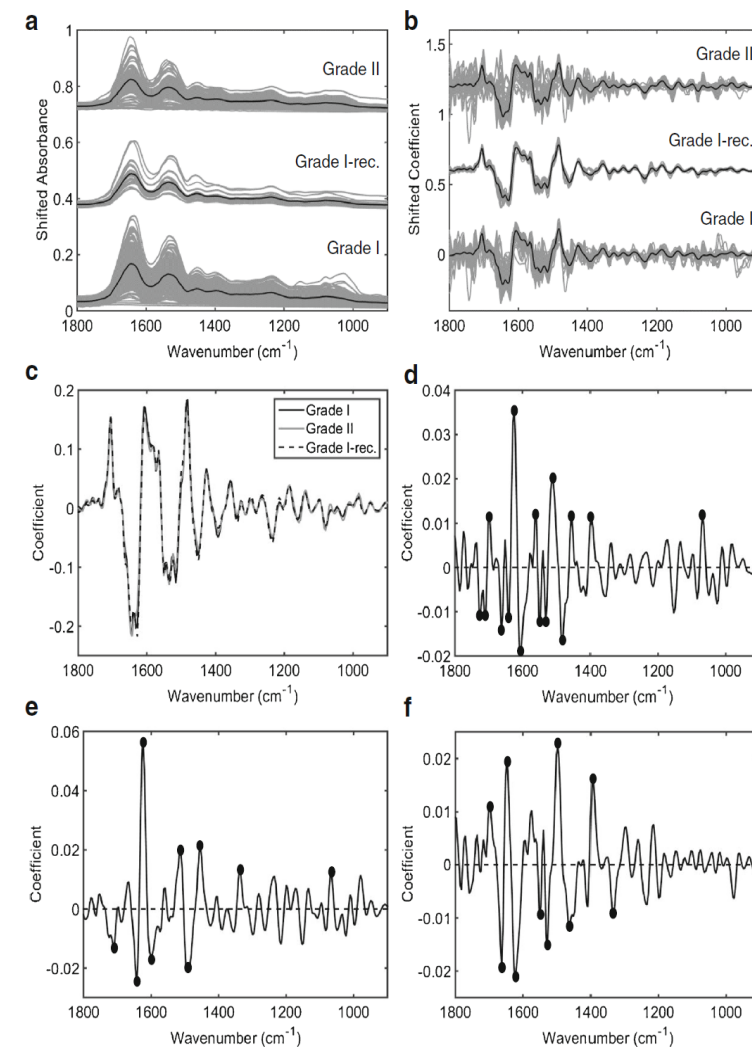

Fig. 1 H&E slides. (a) WHO grade I meningioma (transitional meningioma). (b) WHO grade II meningioma (clear cell)

**Table 3** Quality metrics for PCA-LDA and PLS-DA models to distinguish grade I vs. grade I recurrence samples

Algorithm	Dataset	Accuracy (%)	Sensitivity (%)	Specificity (%)
PCA-LDA	Training	95	99	34
	Validation	95	99	32
PLS-DA	Training	96	96	100
	Validation	94	94	94

**Fig. 2** Infrared spectra for meningioma tumour samples (grade I, grade I recurrence and grade II). (a) Raw spectra and (b) pre-processed spectra (Savitzky-Golay 2<sup>nd</sup> derivative and vector normalisation), where black line represents mean spectrum. (c) Mean spectrum for each class overlaid. (d) Difference-between-mean (DBM) spectrum for grade II (+) vs. grade I (-) meningiomas. (e) DBM spectrum for grade II (+) vs. grade I recurrence (-) meningiomas. (f) DBM spectrum for grade I recurrence (+) vs. grade I (-) meningiomas, where solid dots represent spectral wavenumbers with absolute coefficients > 0.01





## Mini-review

## Biofluid diagnostics by FTIR spectroscopy: A platform technology for cancer detection

Alexandra Sala<sup>a</sup>, David J. Anderson<sup>a</sup>, Paul M. Brennan<sup>b</sup>, Holly J. Butler<sup>c</sup>, James M. Cameron<sup>a</sup>, Michael D. Jenkinson<sup>d</sup>, Christopher Rinaldi<sup>a</sup>, Ashton G. Theakstone<sup>a</sup>, Matthew J. Baker<sup>a,c,\*</sup>

<sup>a</sup> WestCHEM, Department of Pure and Applied Chemistry, University of Strathclyde, Technology and Innovation Centre, 99 George Street, Glasgow, G1 1RD, UK

<sup>b</sup> Translational Neurosurgery, Department of Clinical Neurosciences, Western General Hospital, Edinburgh, EH4 2XU, UK

<sup>c</sup> ClinSpec Diagnostics Ltd., Technology and Innovation Centre, 99 George Street, Glasgow, G1 1RD, UK

<sup>d</sup> Institute of Translational Medicine, University of Liverpool & the Walton Centre NHS Foundation Trust, Lower Lane, Fazakerley, Liverpool, L9 7JJ, UK



A. Sala, et al.

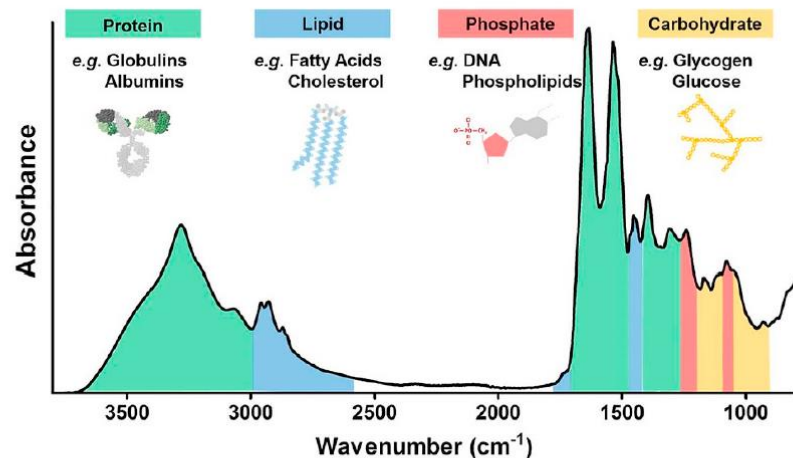

Fig. 2. Human blood serum spectrum acquired by ATR-FTIR spectroscopy with relative biomolecules associated to peaks. Adapted with permission from Ref. [22].

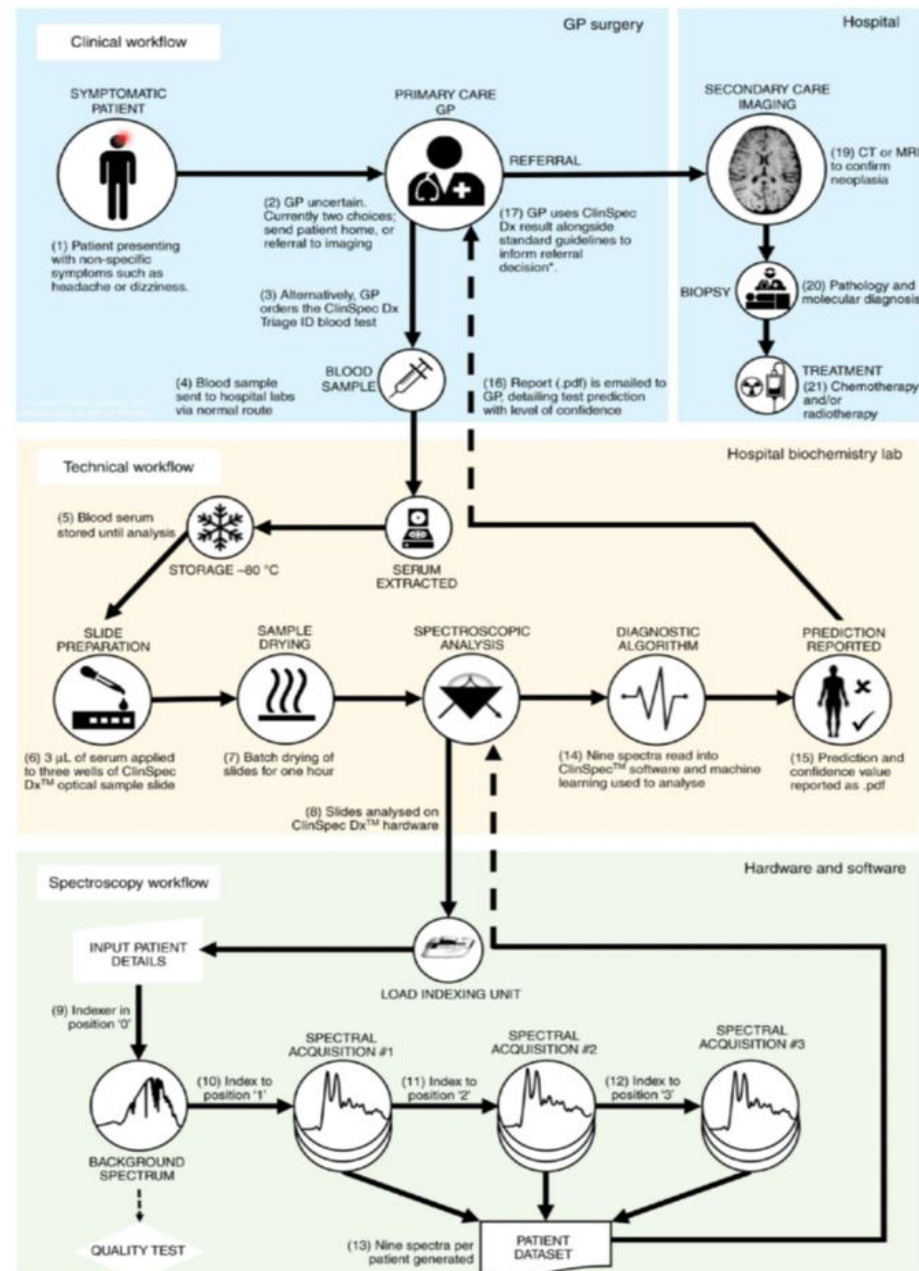

Fig. 3. Proposed integration of a blood test for the triage of brain cancer. Reproduced from Ref. [31] (CC by 4.0).