

UNFOLDED PROTEIN RESPONSE AND KDEL SIGNALLING

Michele Sallesse "G. d'Annunzio" University

Of Chieti-Pescara

2023

ENDOMEMBRANE SYSTEM

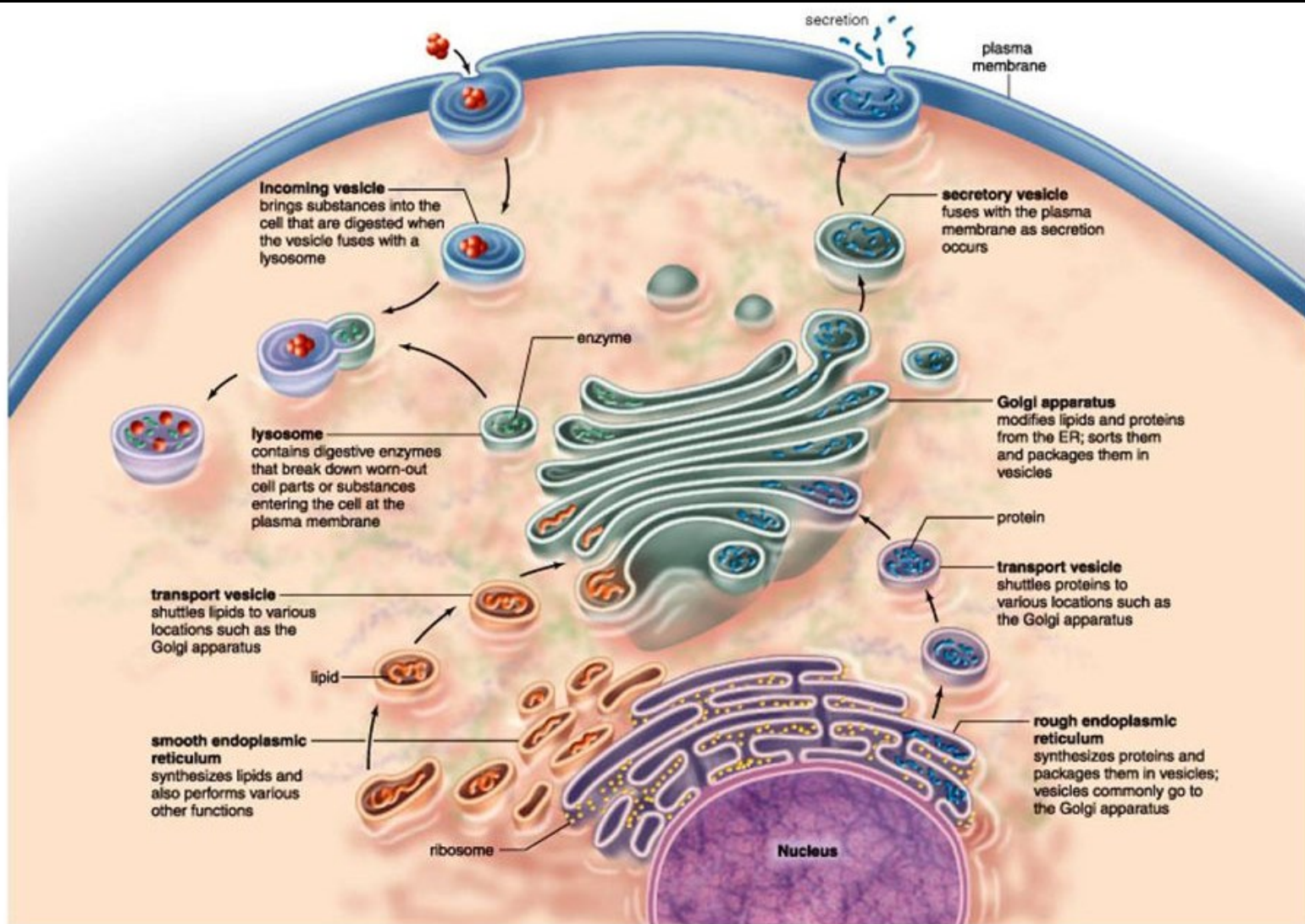

PROTEIN SYNTHESIS

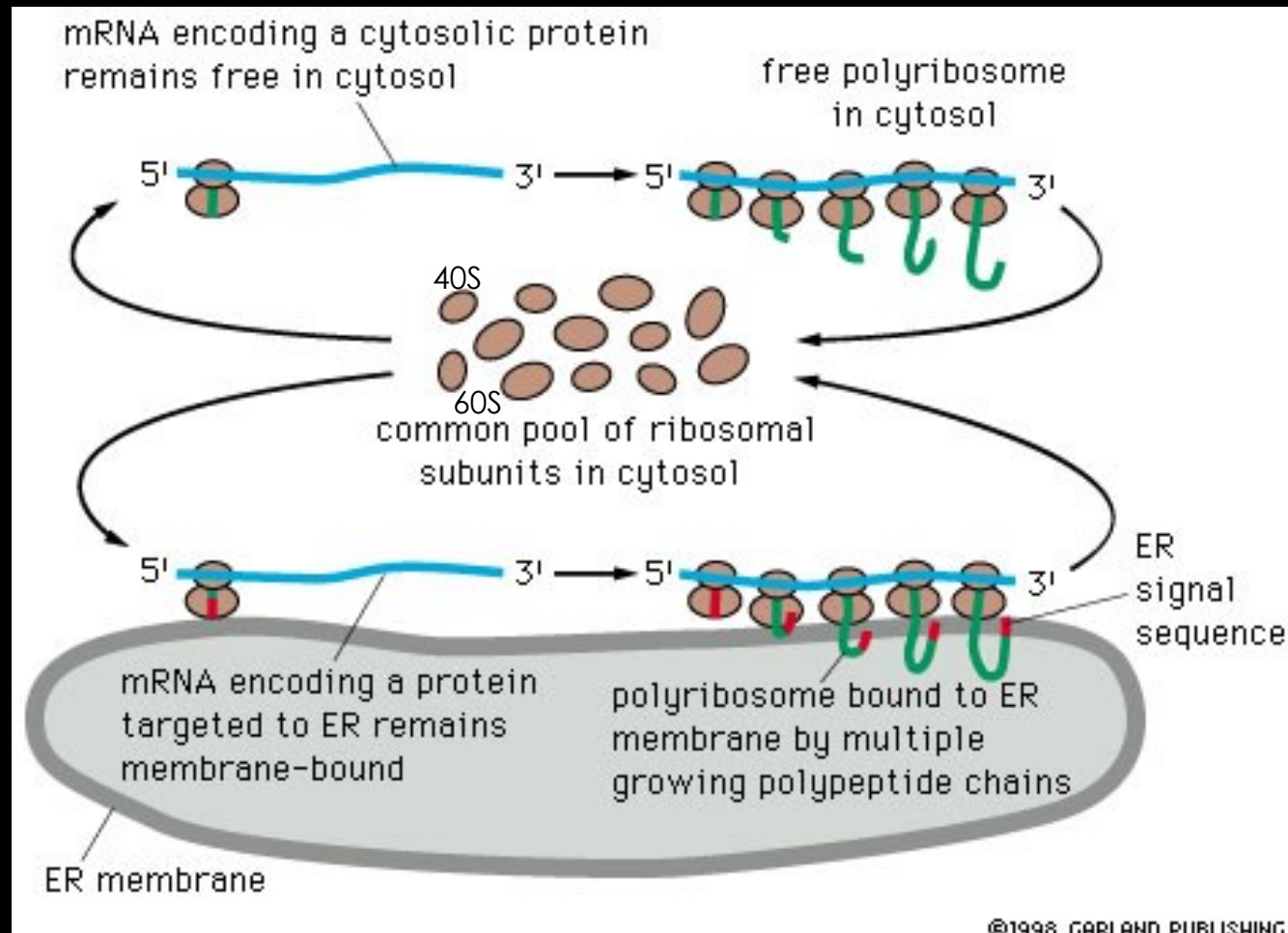

THE SIGNAL RECOGNITION PARTICLE: SRP

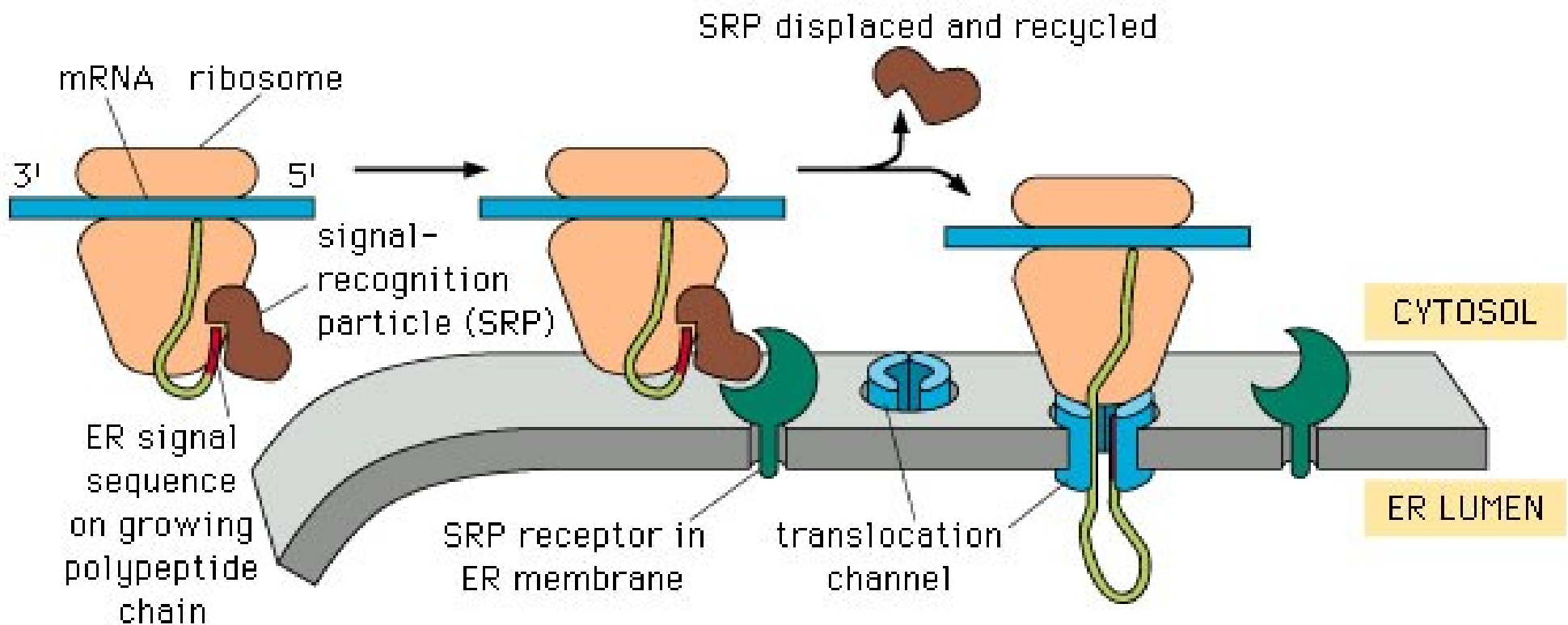

EXPERIMENTAL TEST SHOWING THAT ER TARGETING SIGNAL IS BOTH NECESSARY AND SUFFICIENT TO BRING ABOUT TARGETING

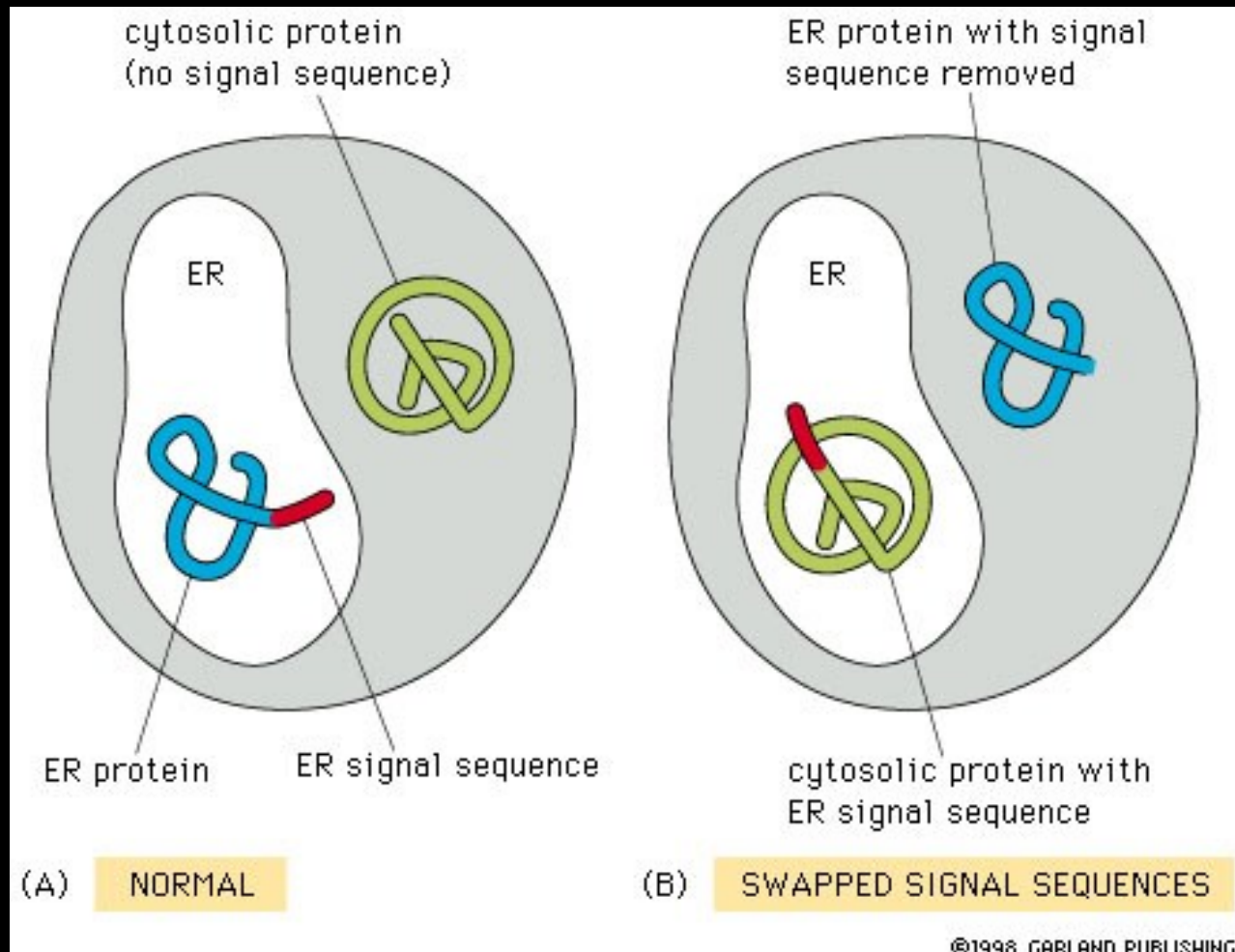

N-GLYCOSYLATION: A CRITICAL STEP IN PROTEIN FOLDING

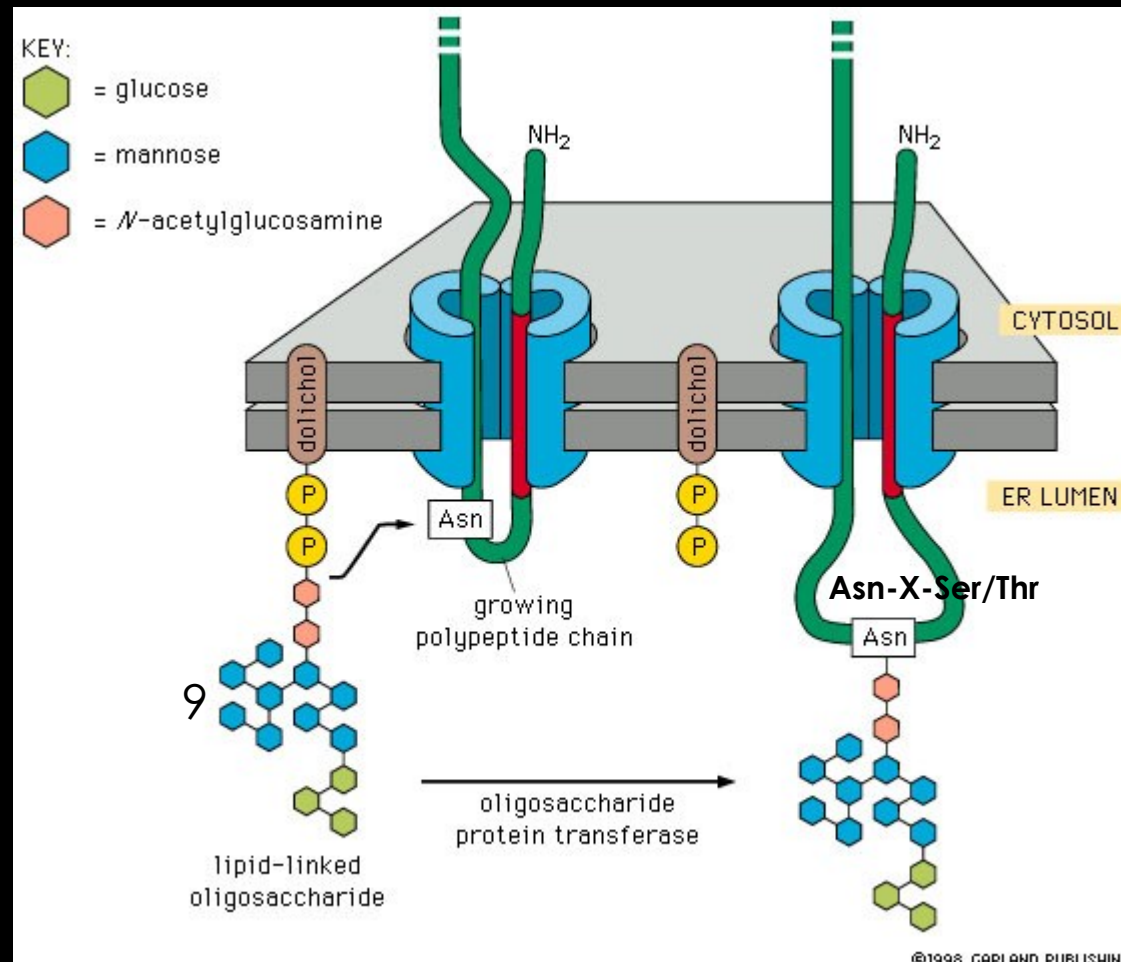

ER lumen

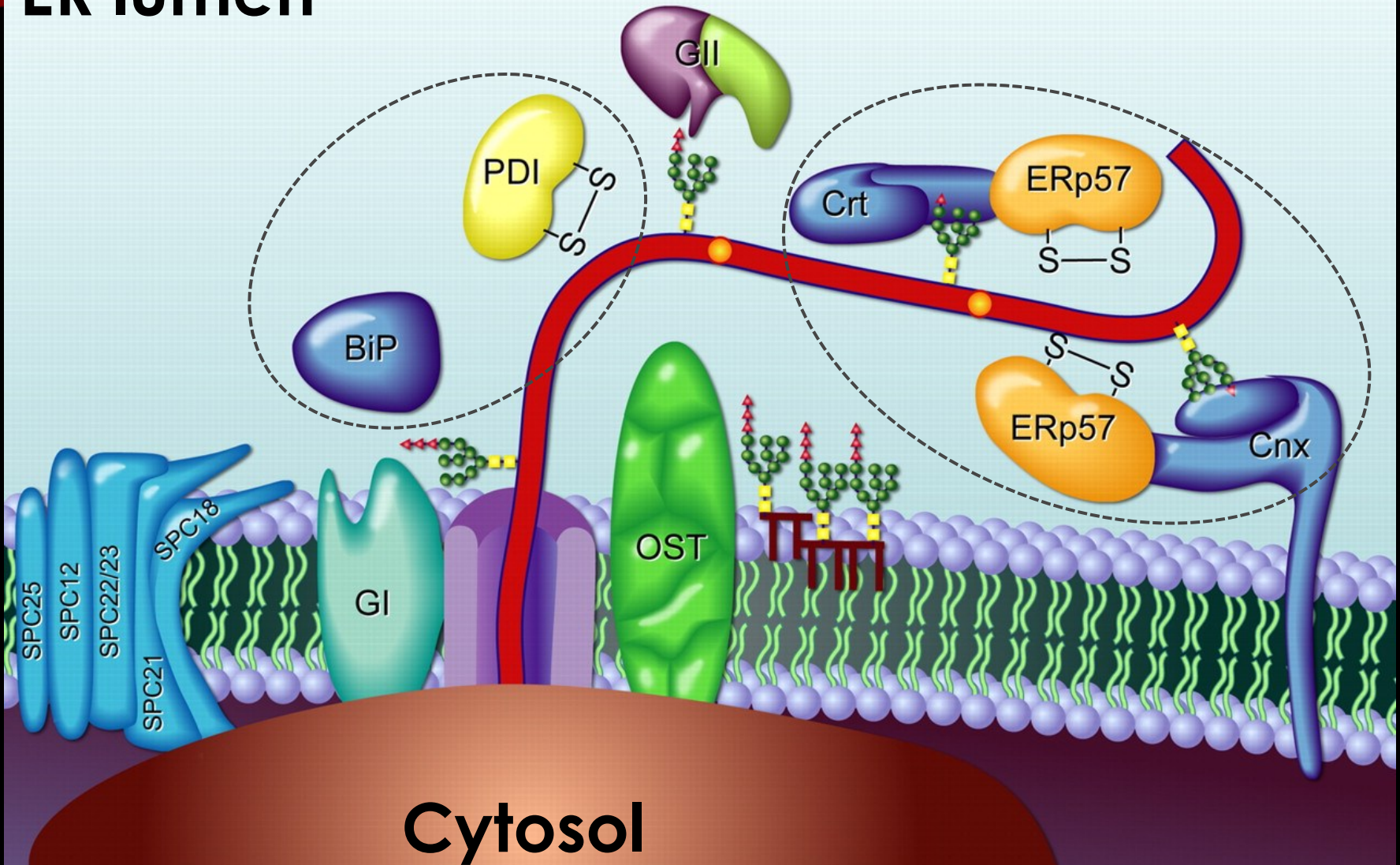

Nascent or
misfolded
protein

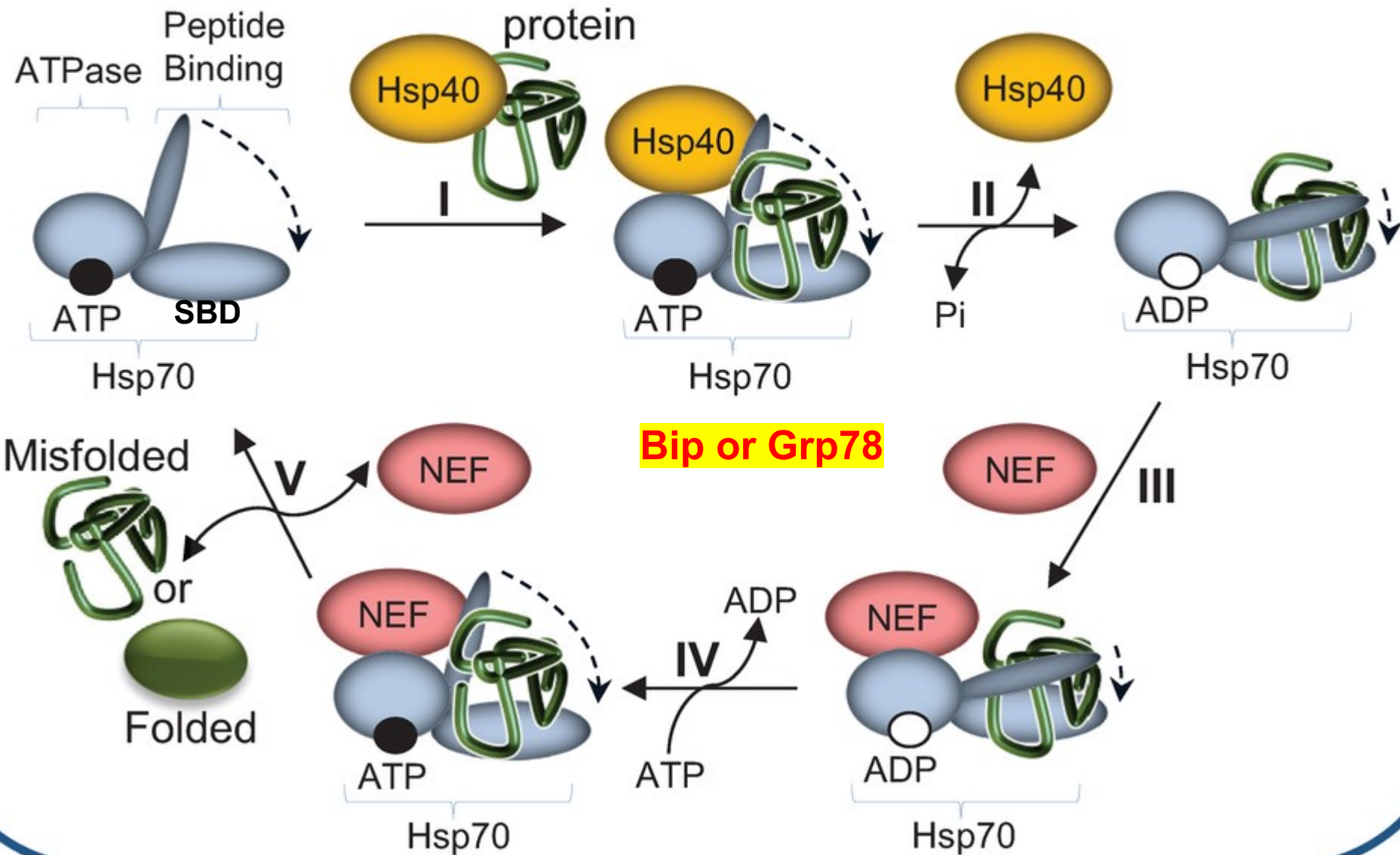

(b)

- N-acetylglucosamine
- Mannose
- Glucose

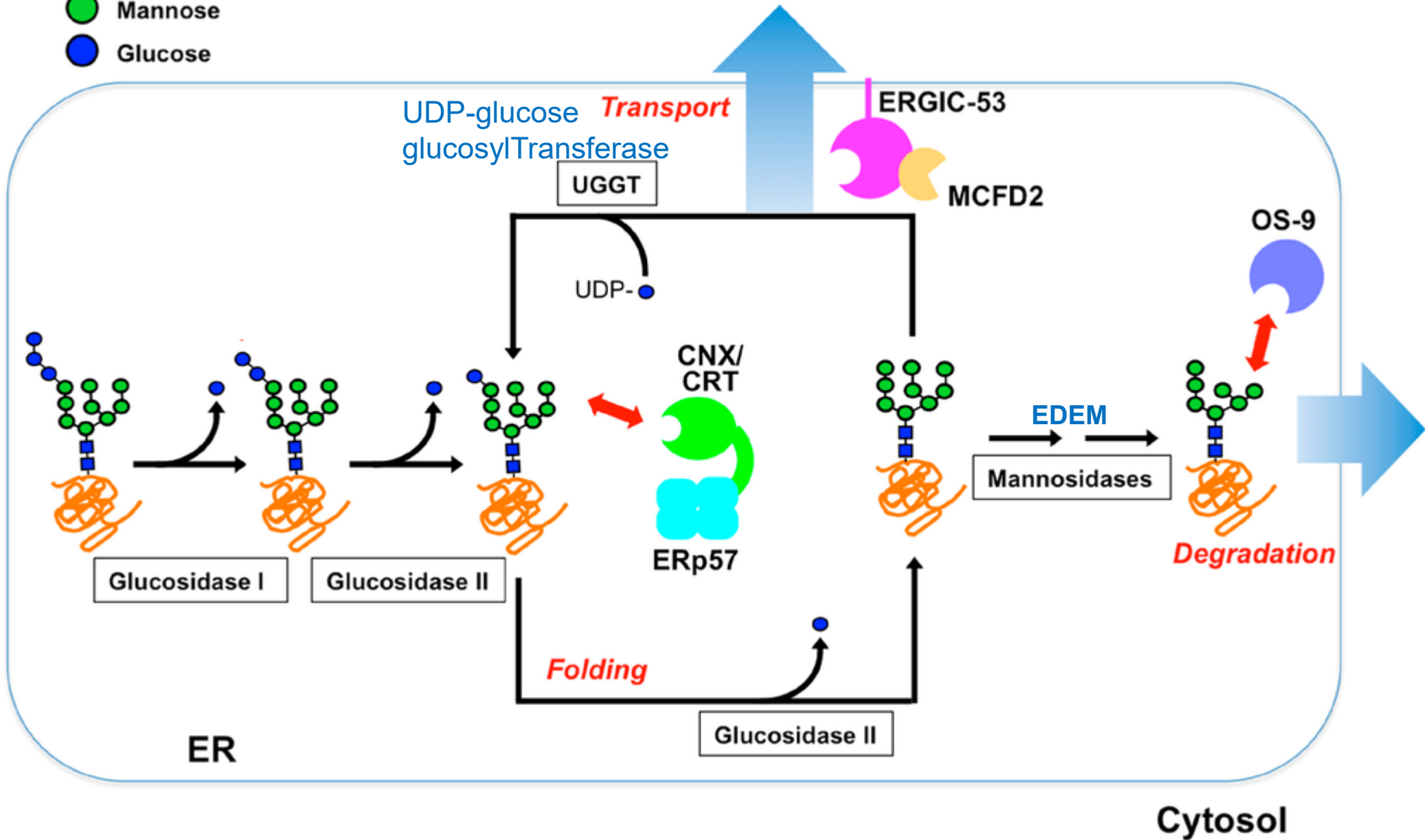

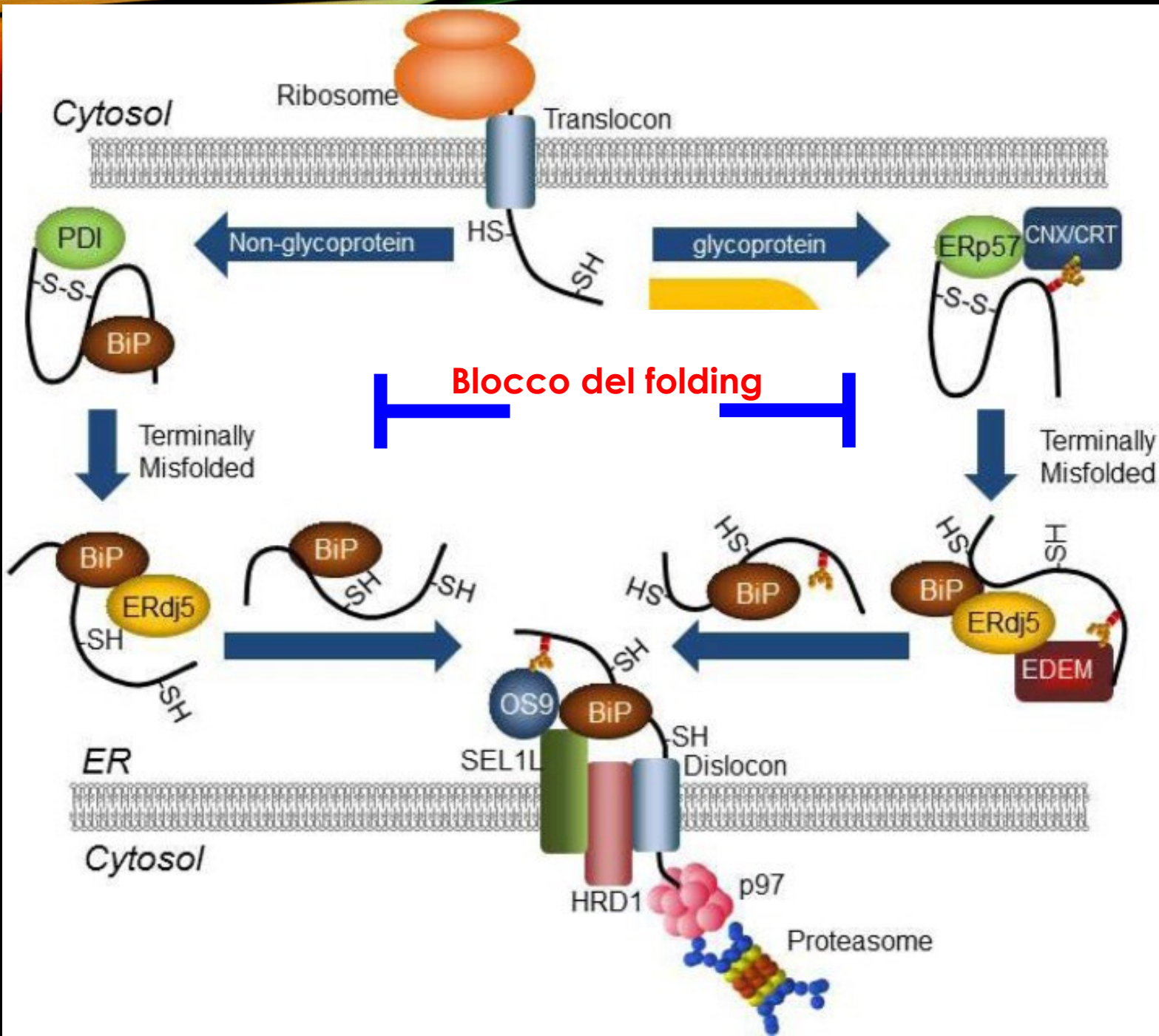



ALTERAZIONI E CONSEGUENZE DEL PROESSO DI FOLDING

TRIGGERS OF ER STRESS

- Development of secretory cells
 - pancreatic β cells
 - plasma cells
- Altered metabolism
 - glucose deprivation
 - hyperhomocysteinemia
- Genetic mutation
 - DNA damage
 - mutated secretory proteins
- Pathogenesis
 - polyglutamine neuropathies
 - viral infection
- Chemical insult
 - inhibition of *N*-linked glycosylation
 - disruption of Ca^{2+} homeostasis

THE UNFOLDED PROTEIN RESPONSE (UPR)

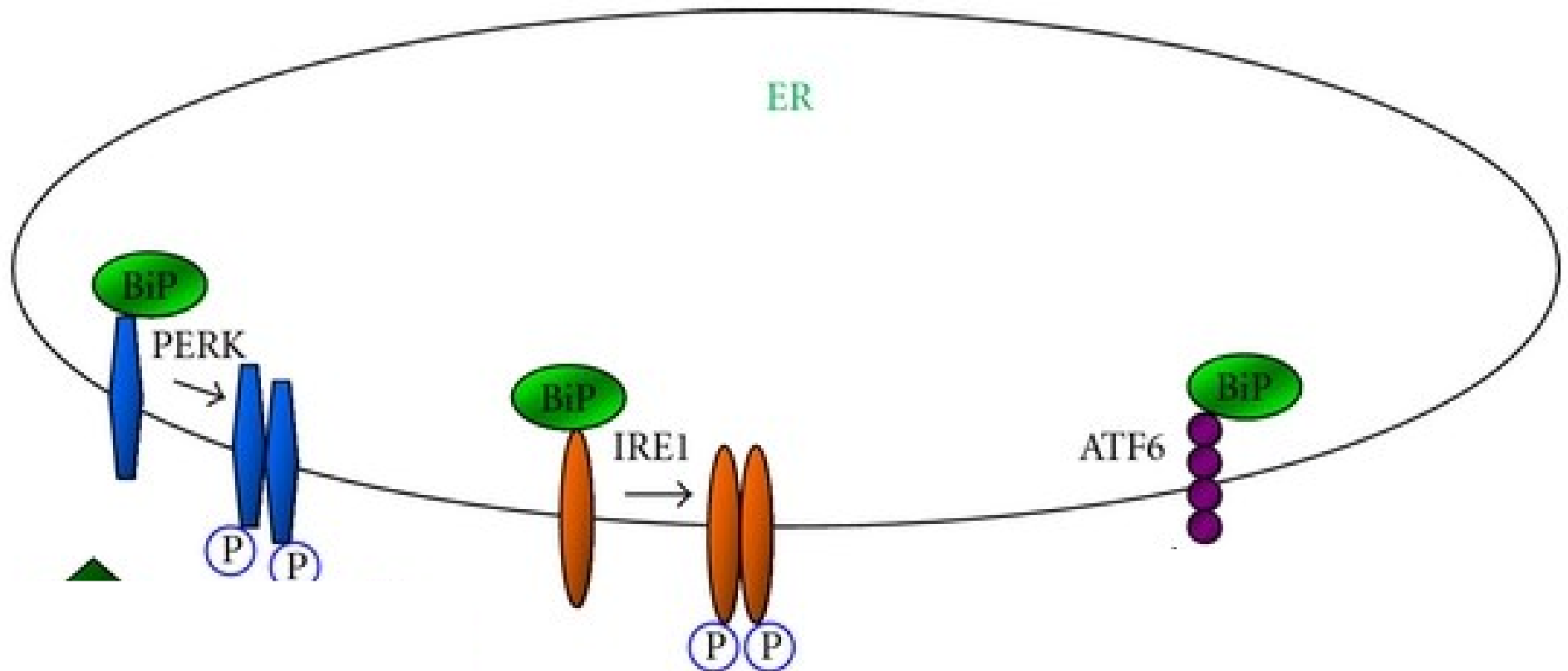

THE UNFOLDED PROTEIN RESPONSE (UPR)

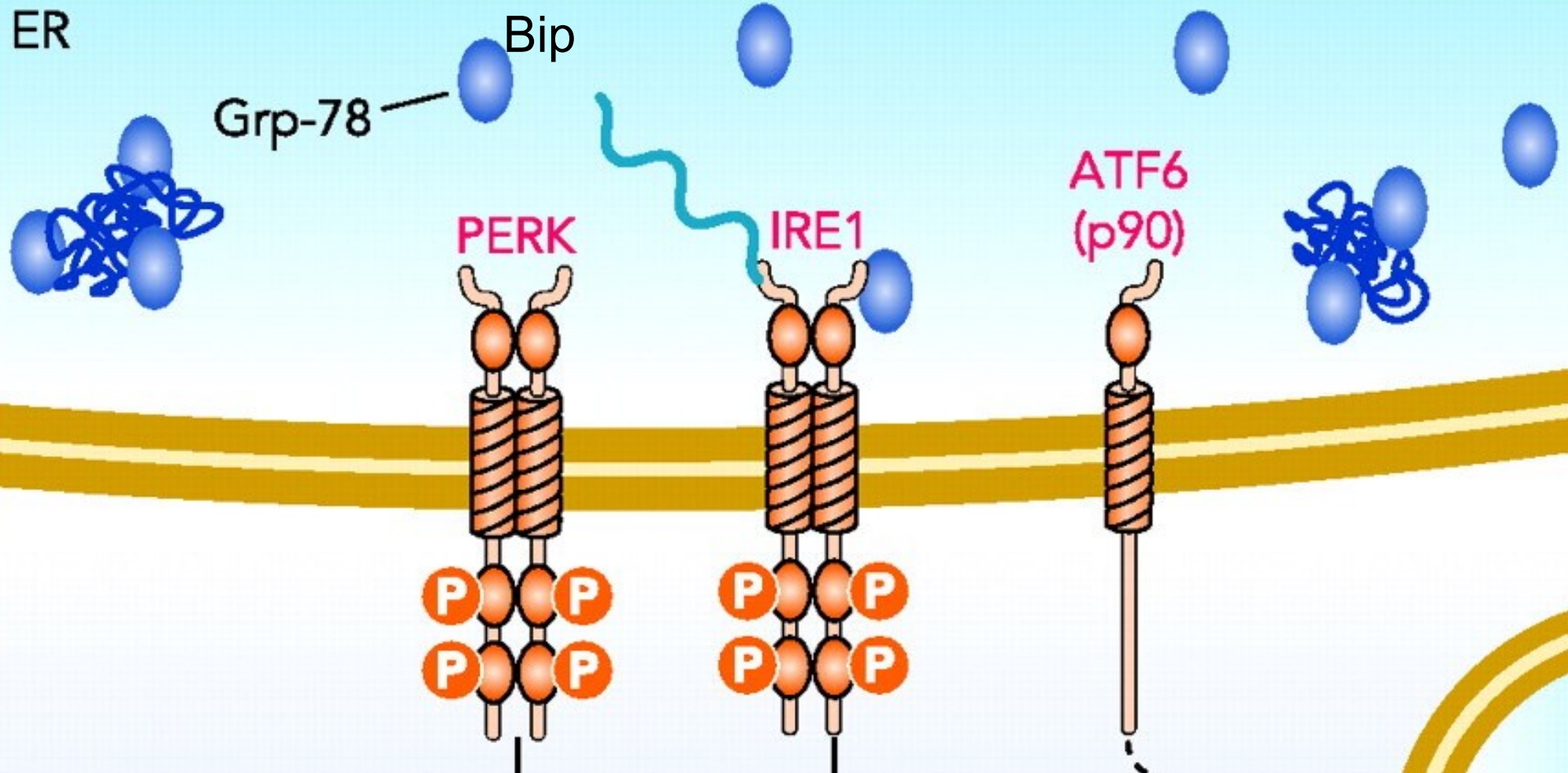

PERK PATHWAY

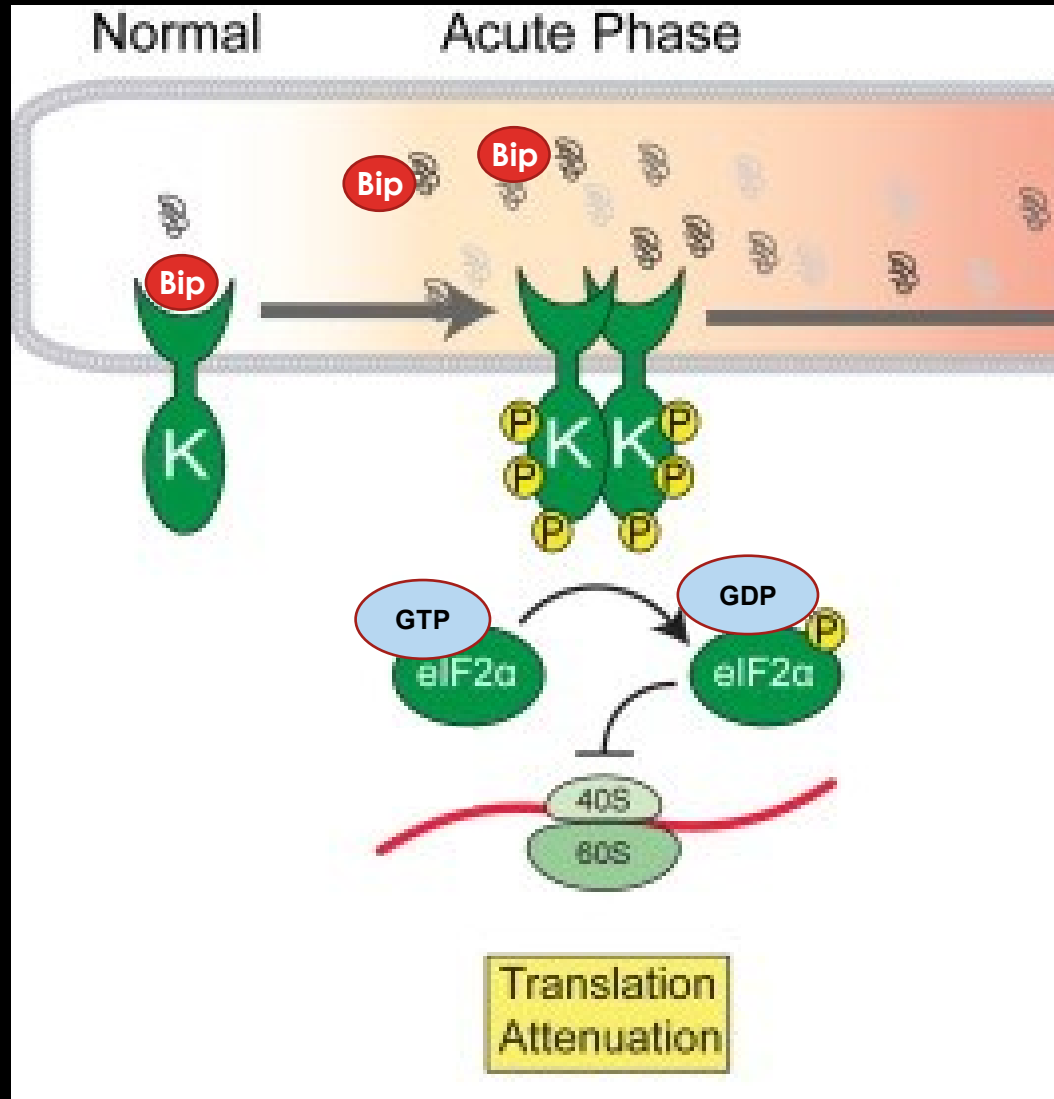

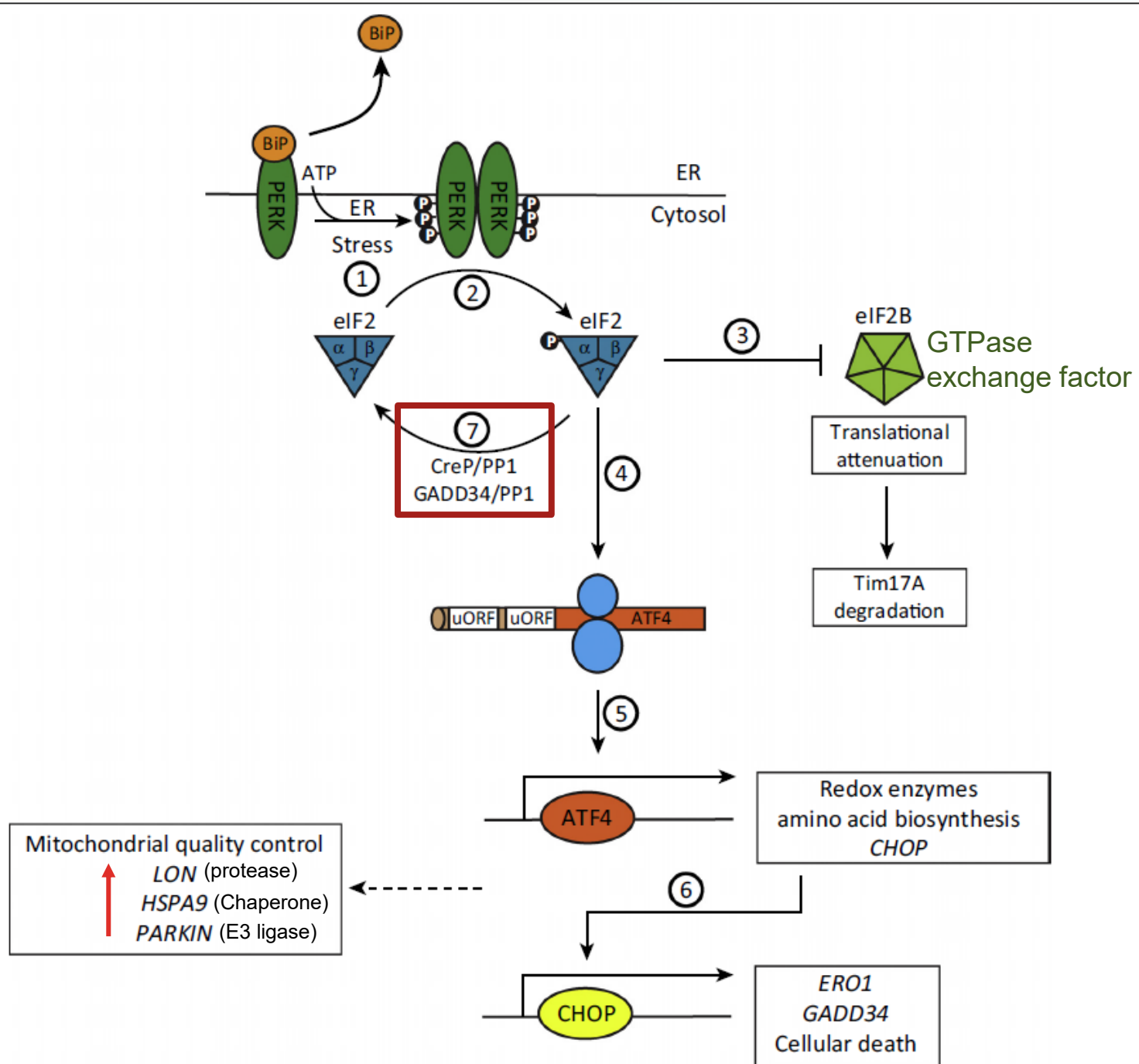

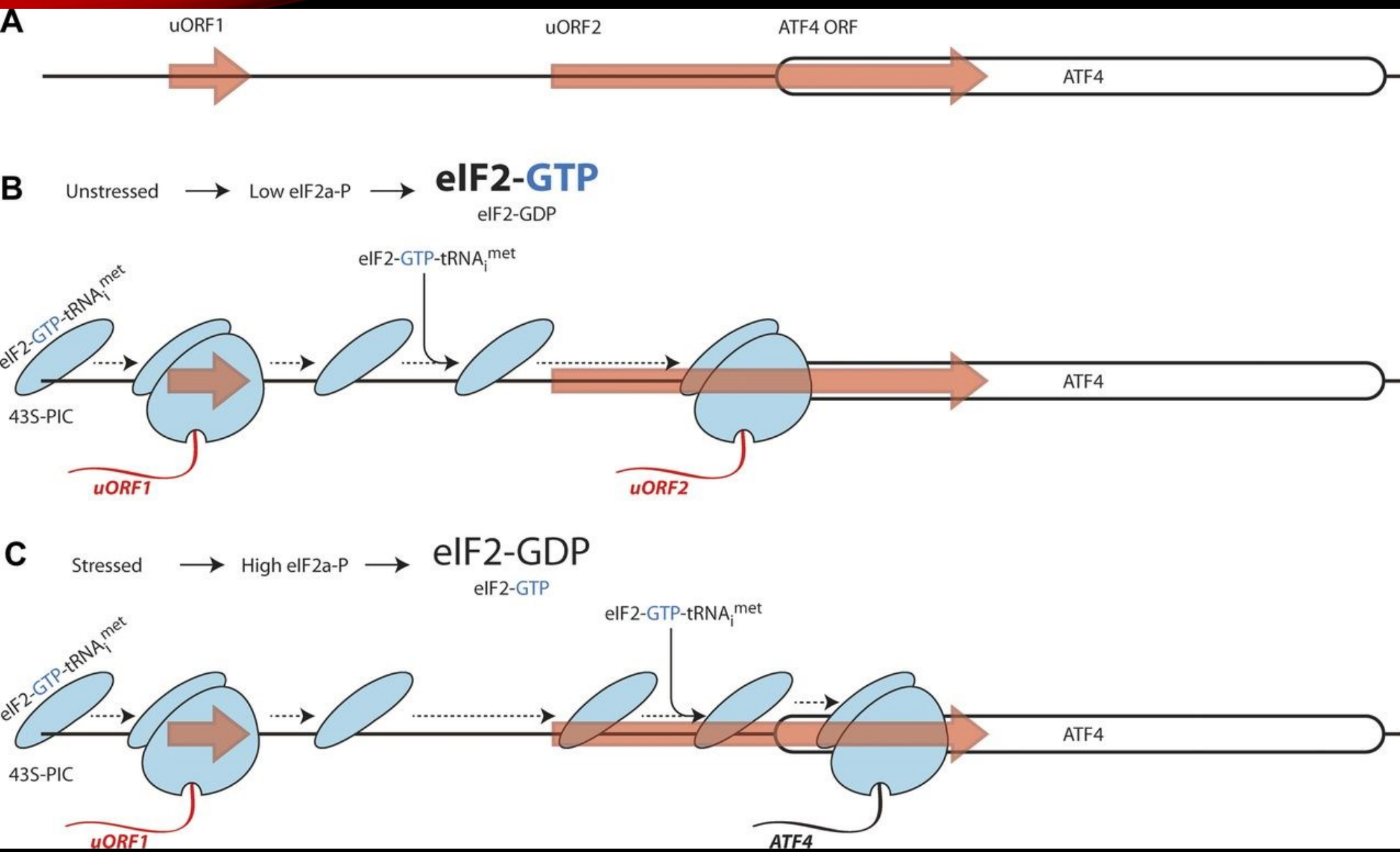

IMPACT OF PERK SIGNALLING ON MITOCHONDRIA

Impact of PERK

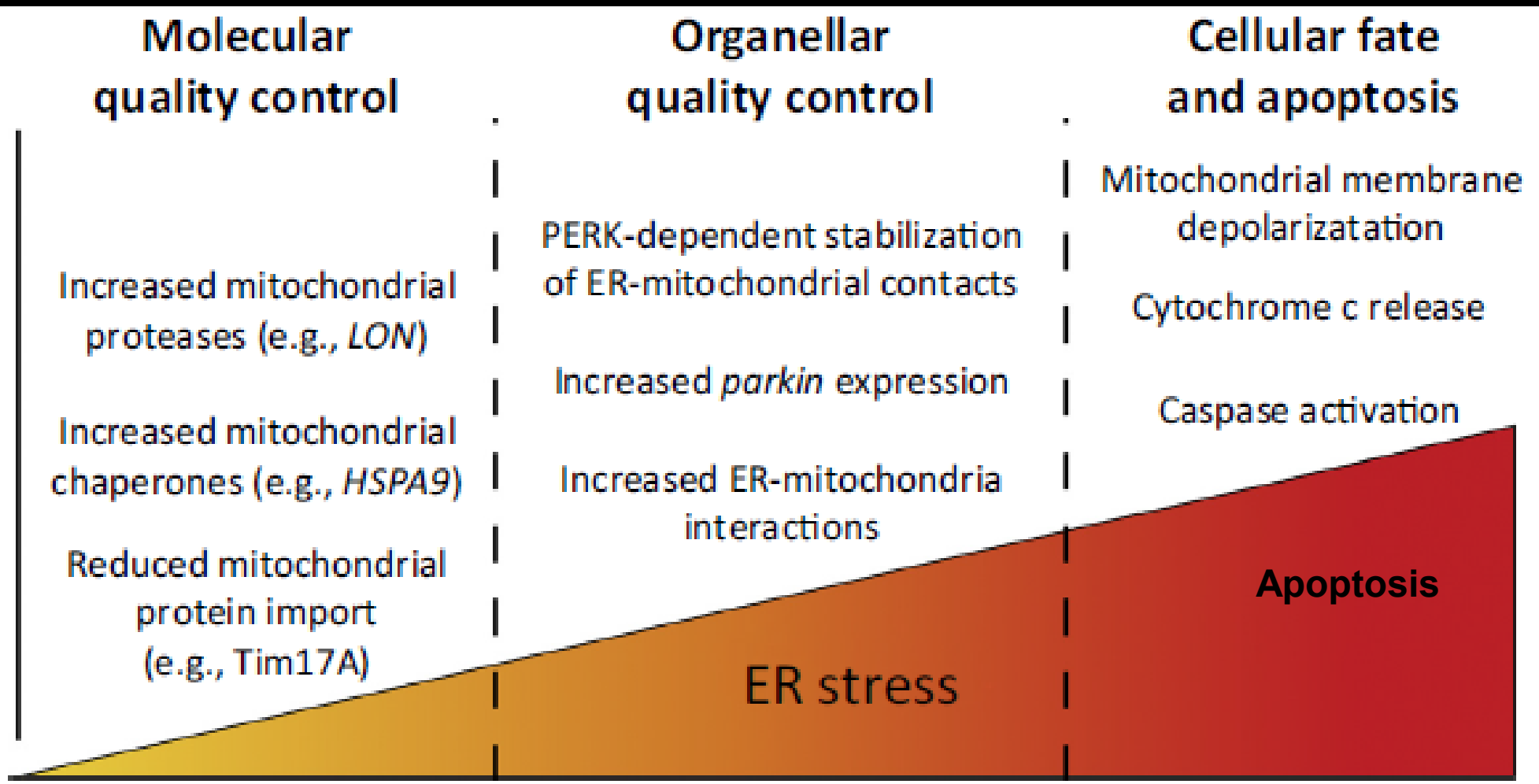

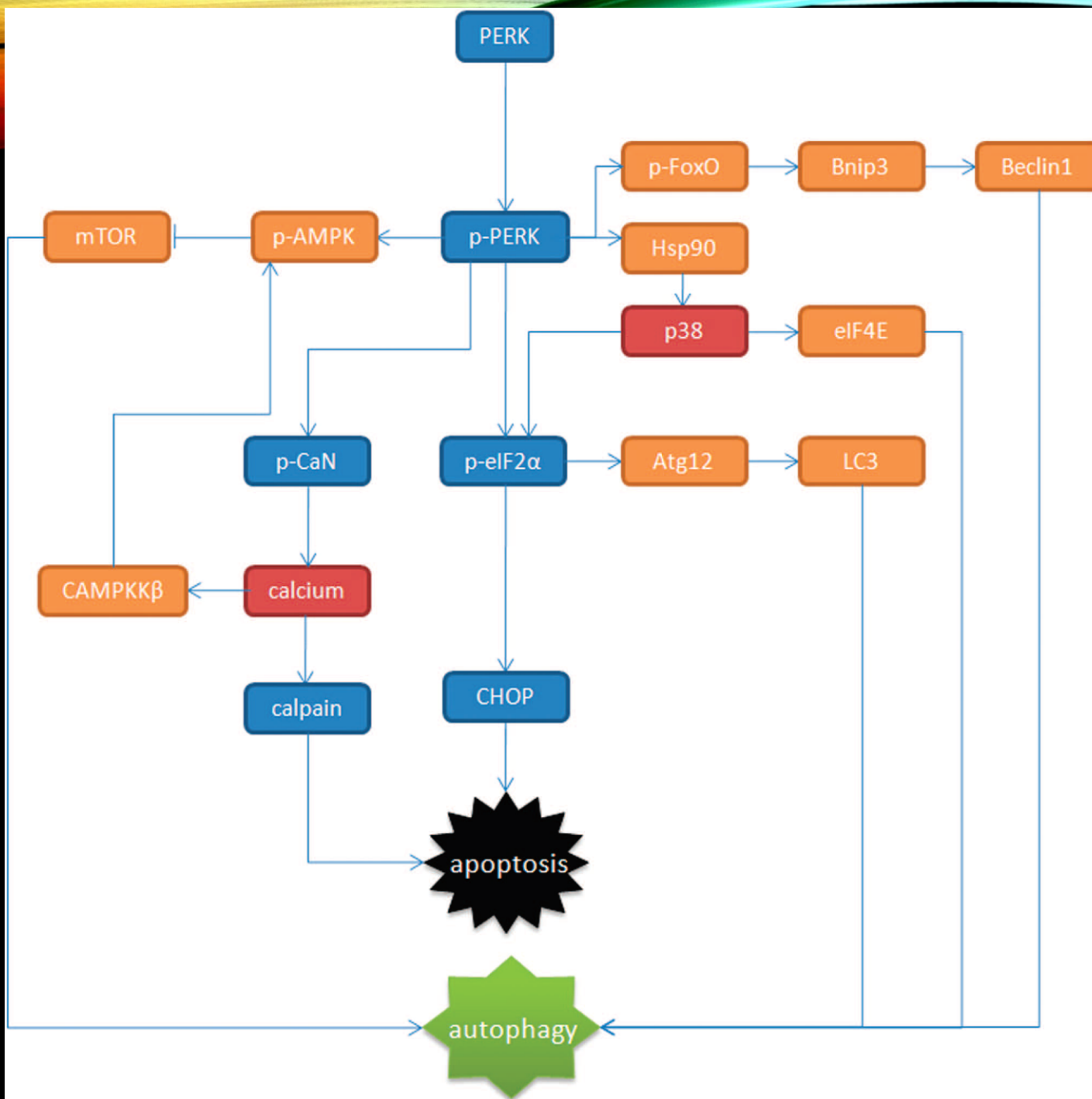

AUTOPHAGY

24

- An intracellular homeostatic mechanism important for degradation of cytoplasmic components in acidic lysosomal compartment
- Targets:
 - Intracellular organelle
 - Misfolded proteins
- Main aims:
 1. It disassembles unnecessary or dysfunctional components
 2. It promotes cellular survival by maintaining cellular energy levels during starvation
 3. adaptive response to stress, this promotes cellular survival in cancer

AUTOPHAGY²⁵

- **Macroautophagy**
 - it is used primarily to waste damaged cell organelles or unused proteins. This involves the formation of a double membrane known as an autophagosome, around the organelle marked for destruction.
- **Microautophagy**
 - It involves the direct engulfment of cytoplasmic material into the lysosome. This occurs by inward folding of the lysosomal membrane.
- **Chaperone-mediated autophagy**
 - It is a protein specific pathway which involves the recognition of KFERQ sequence by the hsc70-containing complex and translocation through the lysosomal membrane.

MACROAUTOPHAGY

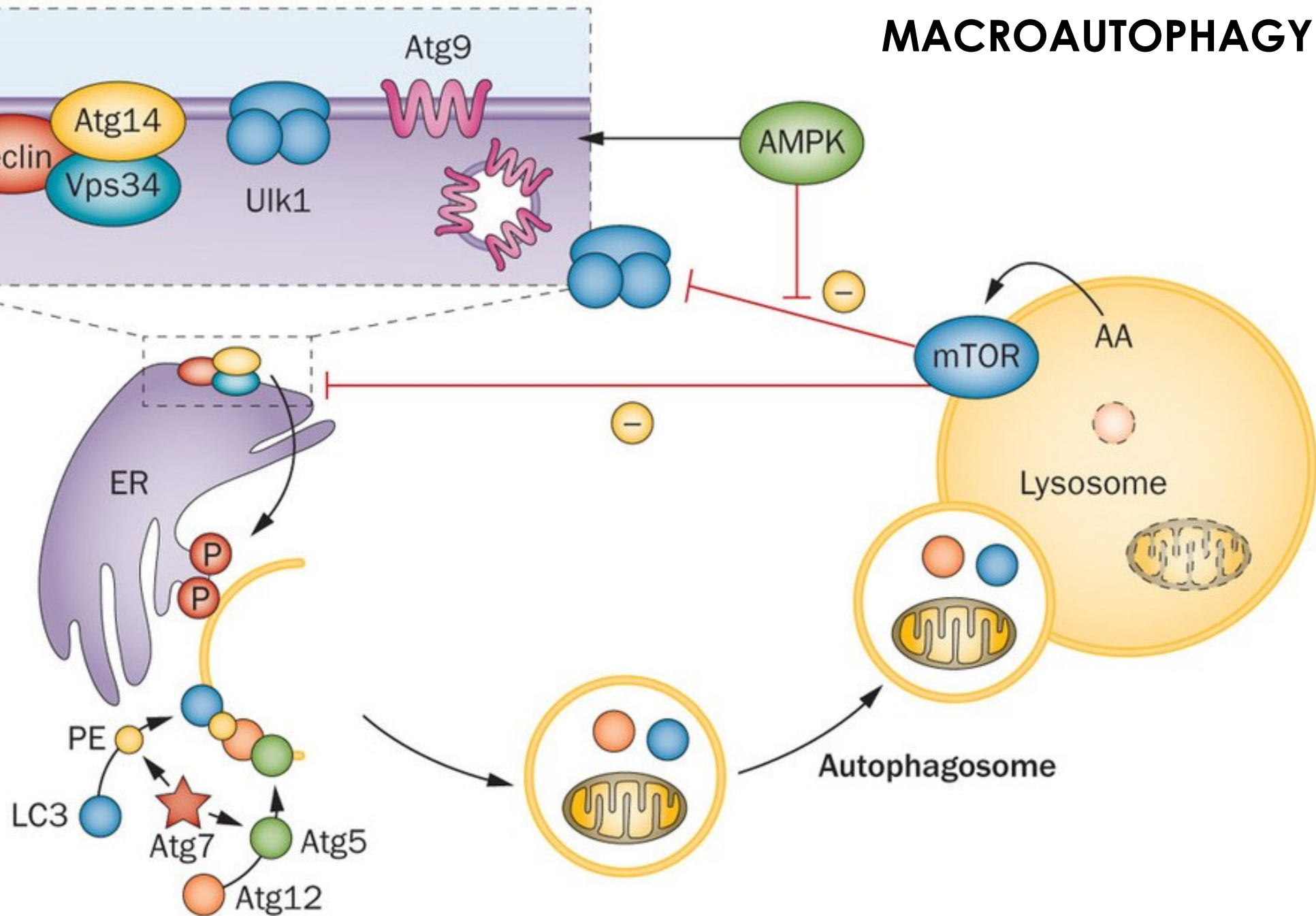

CHAPERONE-MEDIATED AUTOPHAGY AND MICROAUTOPHAGY

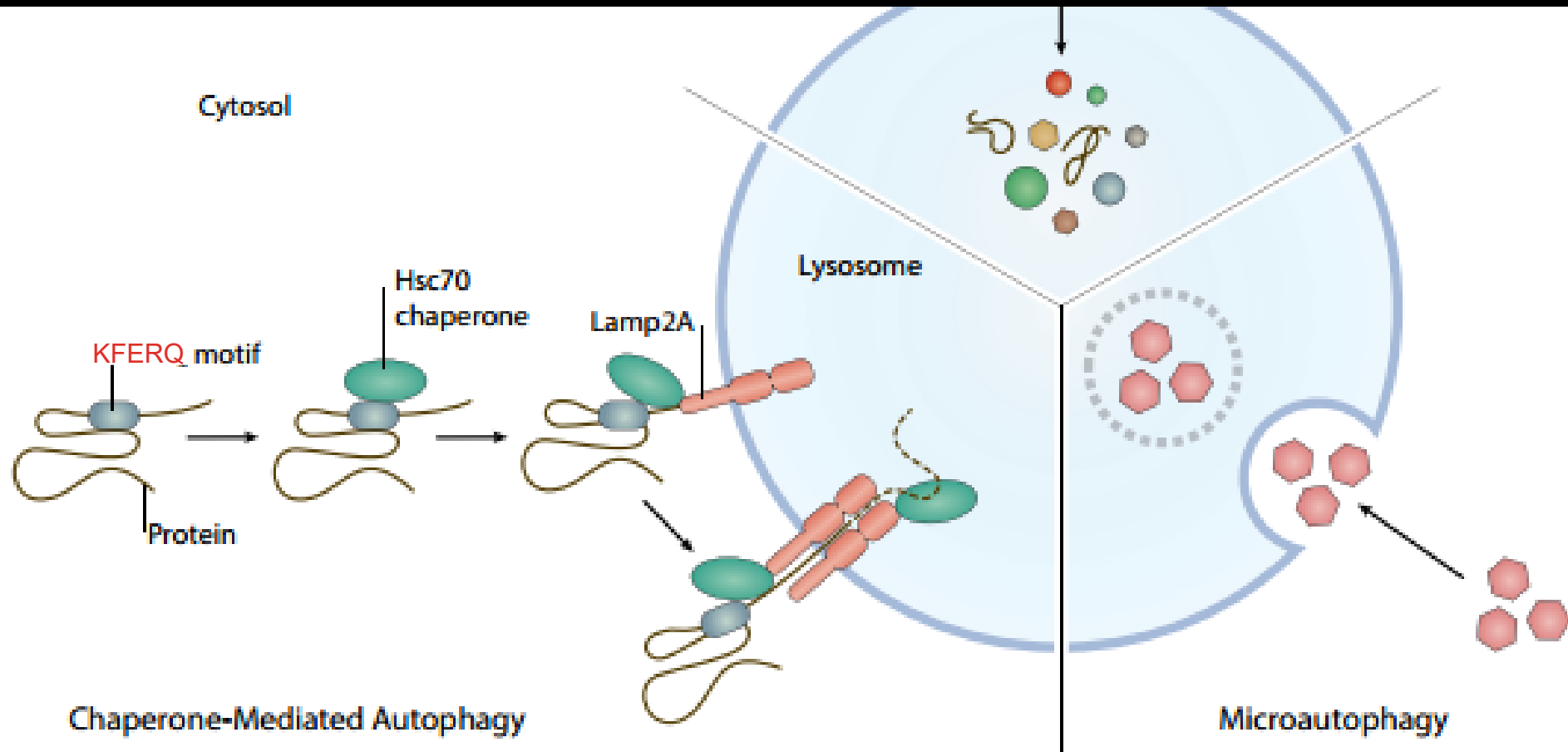

UPR MACHINERY

ER

Grp-78

PERK

IRE1

ATF6
(p90)

P P
P P

P P
P P

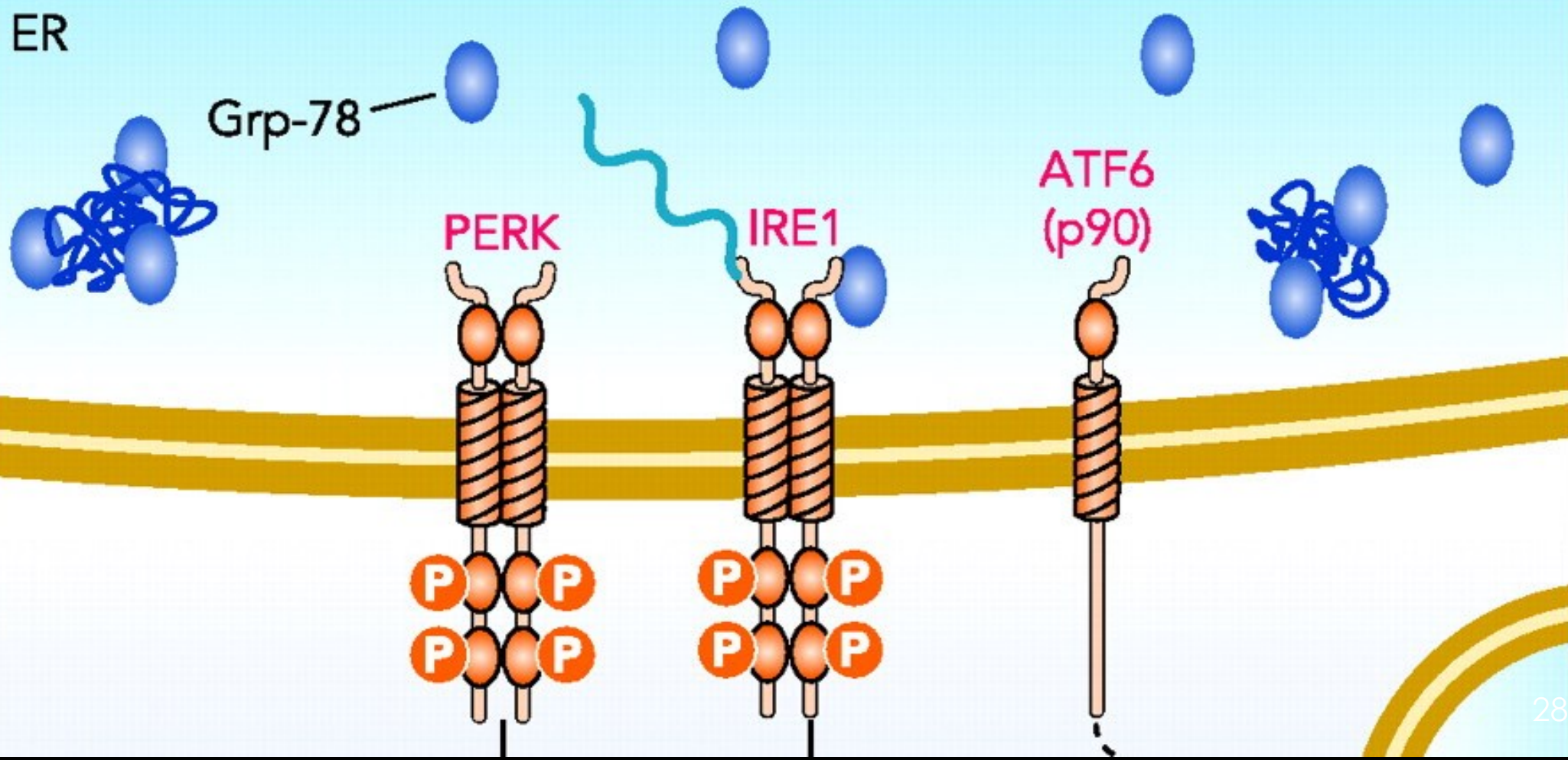

ER lumen

ROS

Misfolded and Unfolded Protein

Stress

IRE1

P

P

Spliced XBP1 protein

mRNA processing

XBP1 mRNA

Ligase

Spliced XBP1 mRNA

Nucleus

Endoribonuclease activity

Gene transcription

- Chaperones
- Foldases (PDI)
- ERAD proteins
- Lipid synthesis

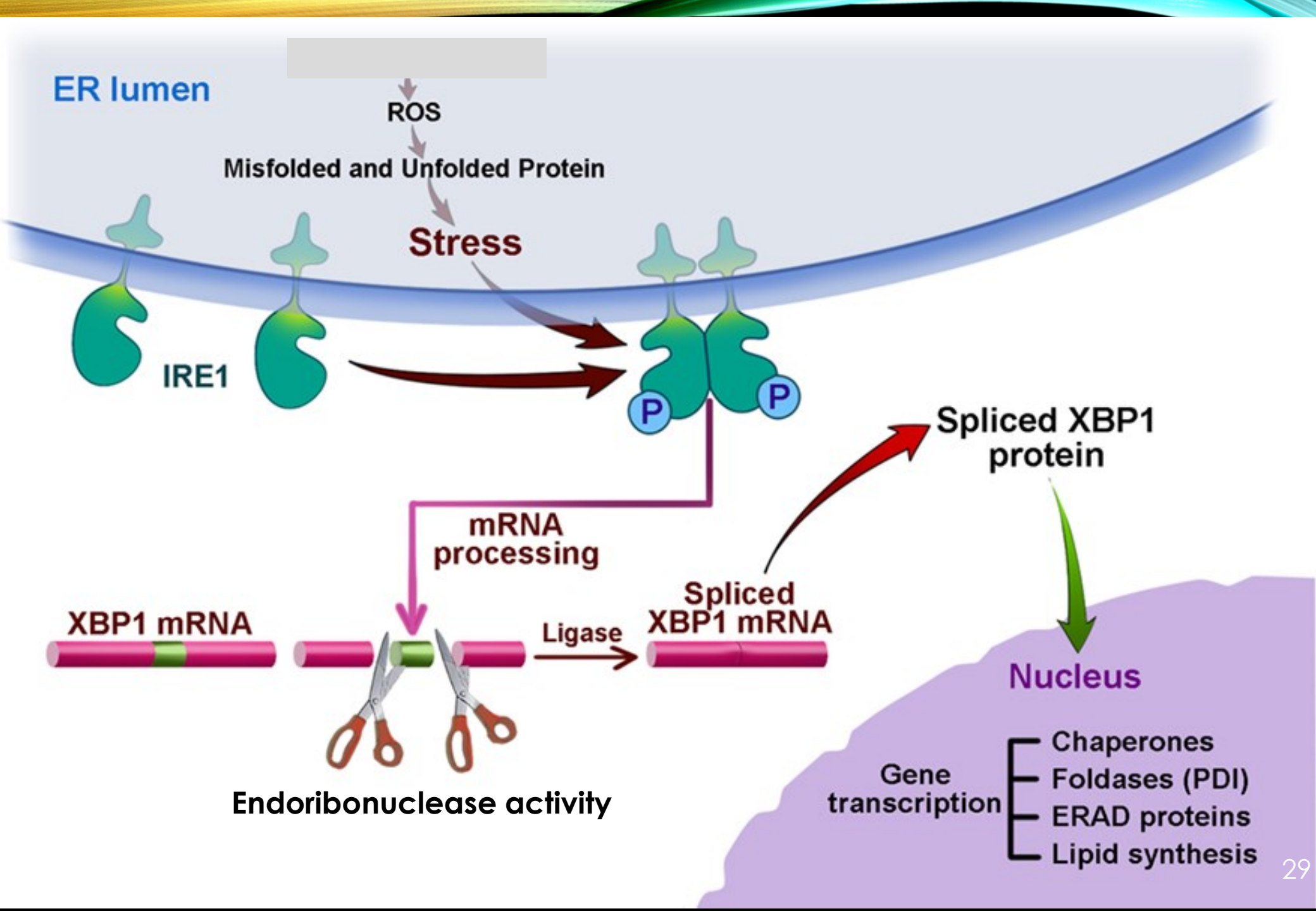

REGULATED IRE1 DEPENDENT DECAY (RIDD)

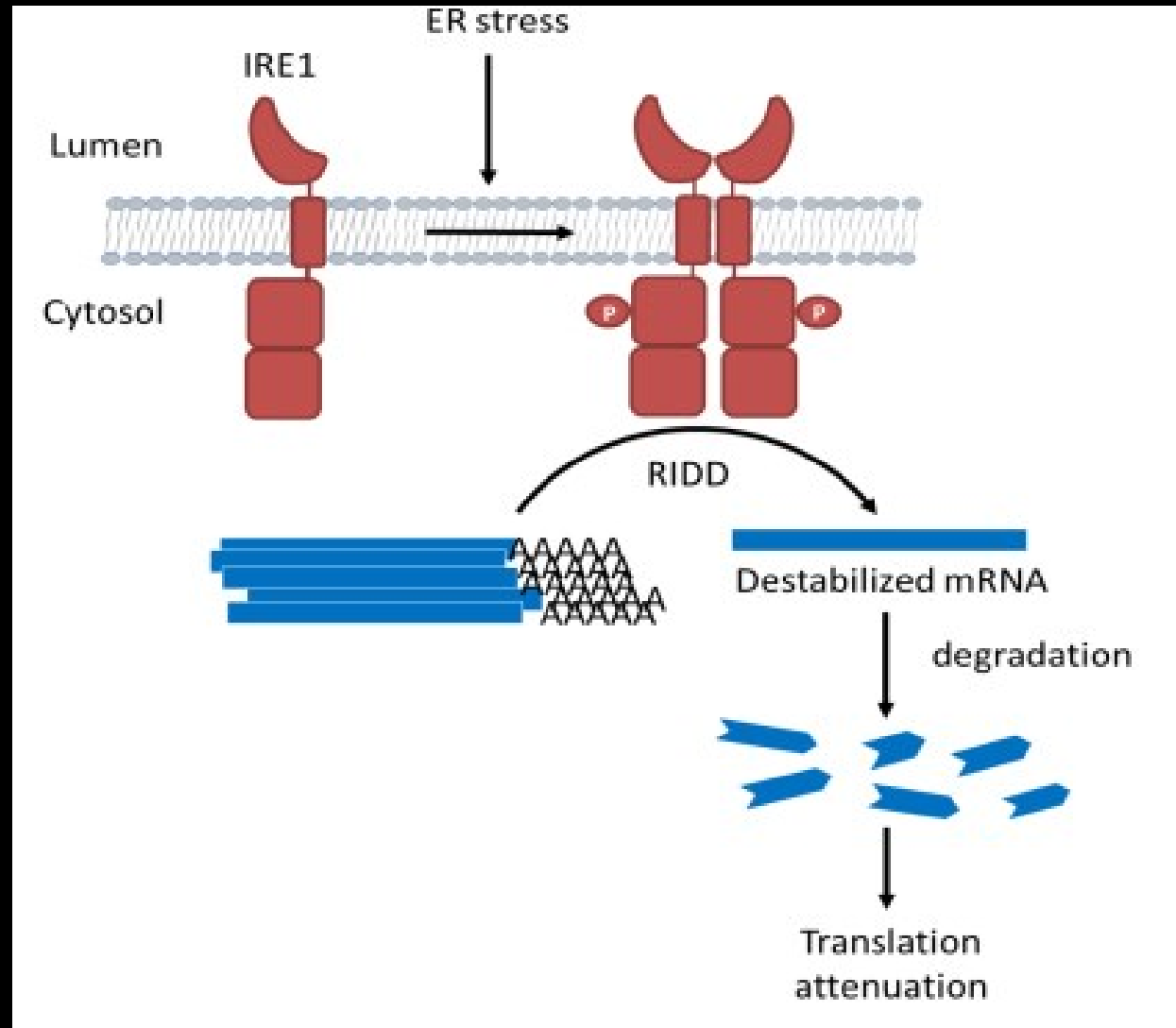

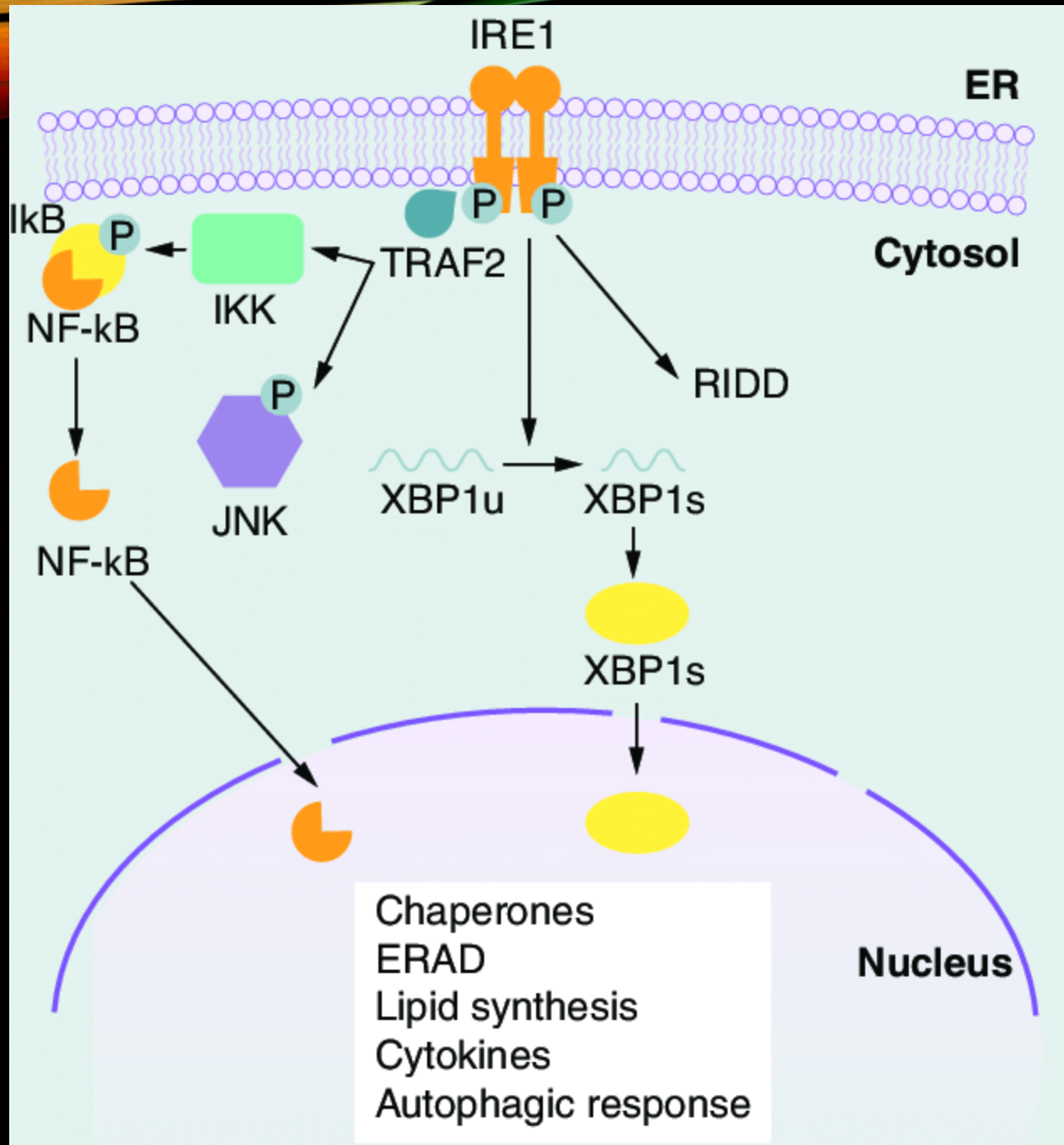

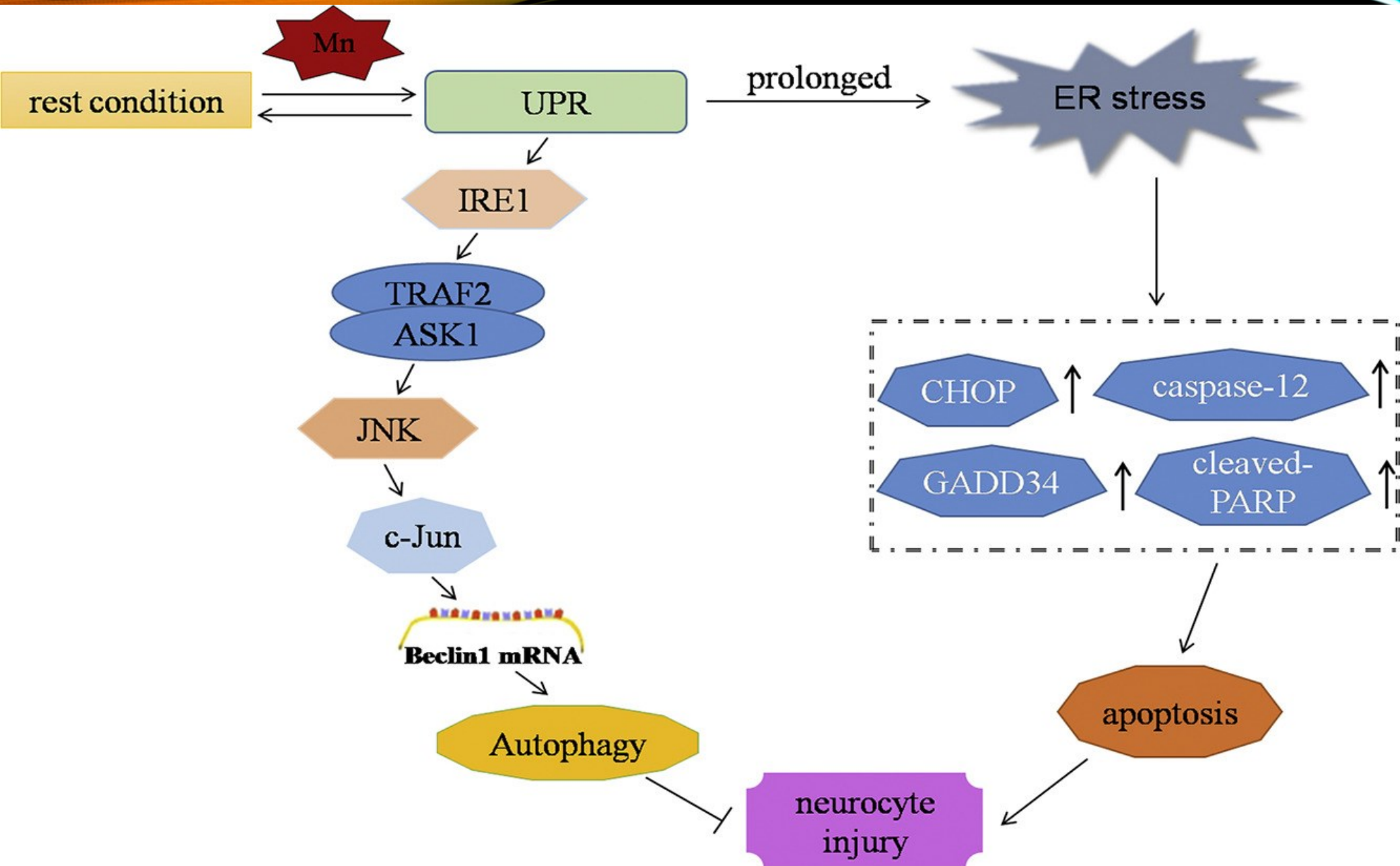

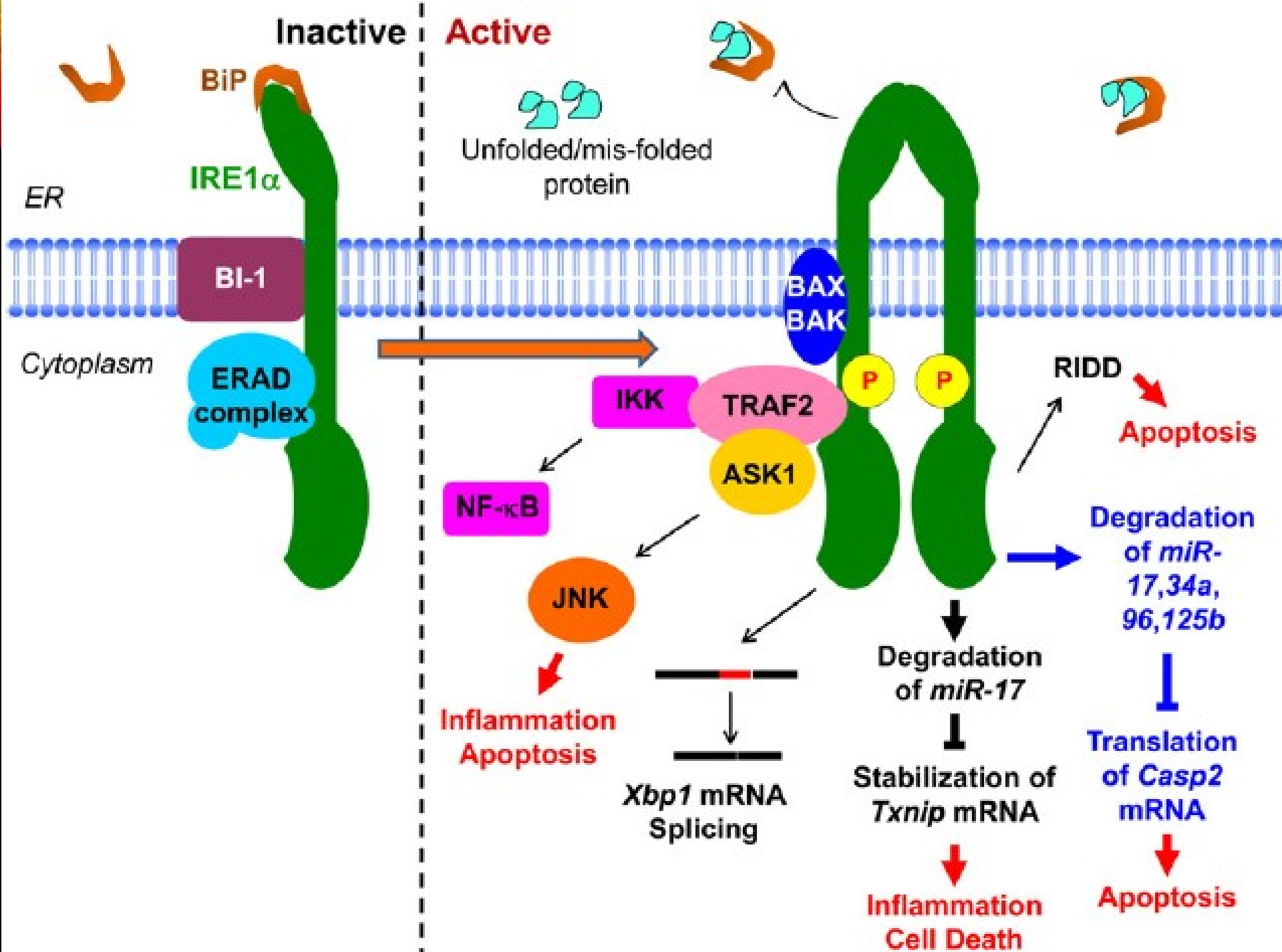

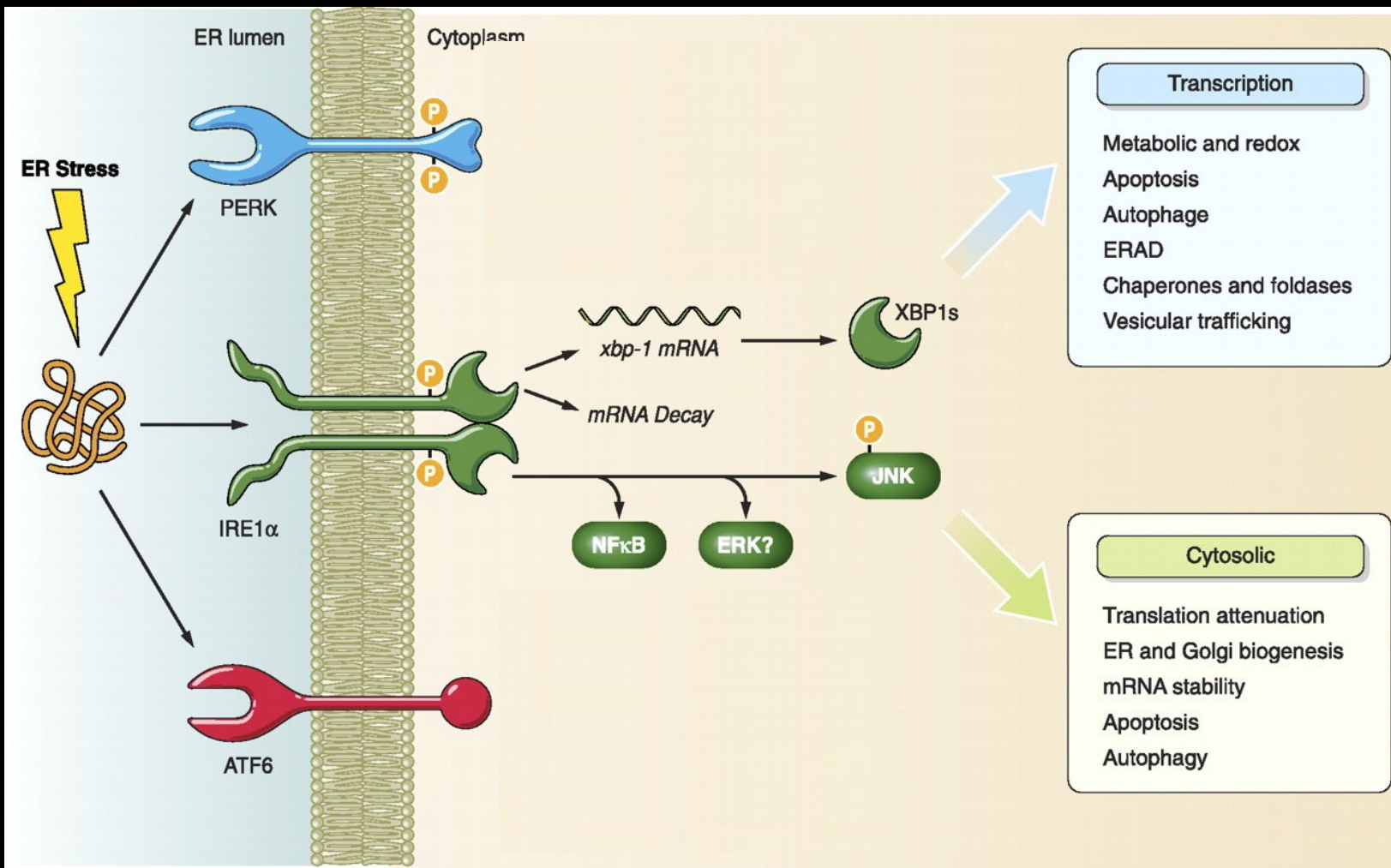

UPR MACHINERY

ER

Grp-78

PERK

IRE1

ATF6
(p90)

P P
P P

P P
P P

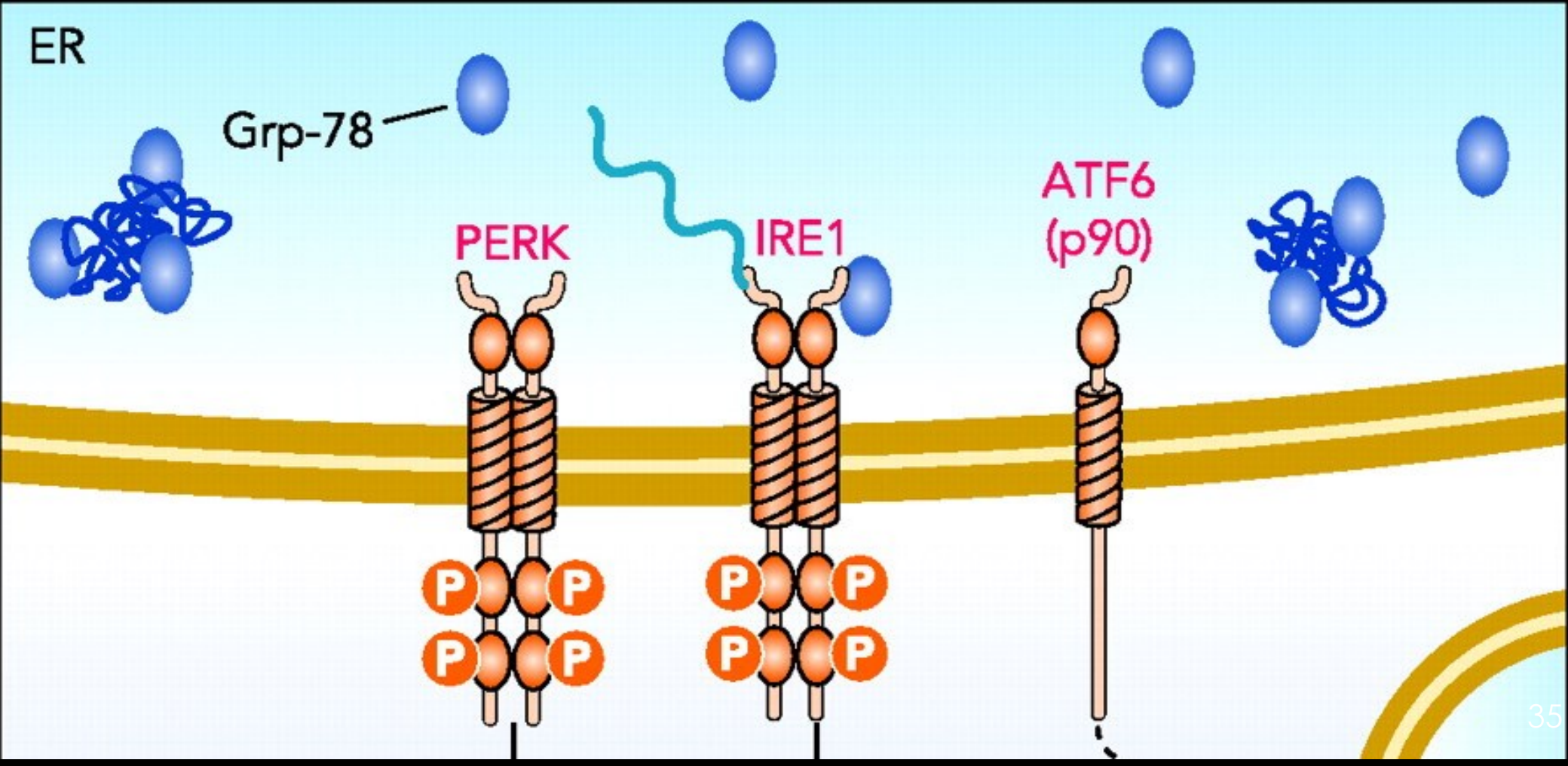

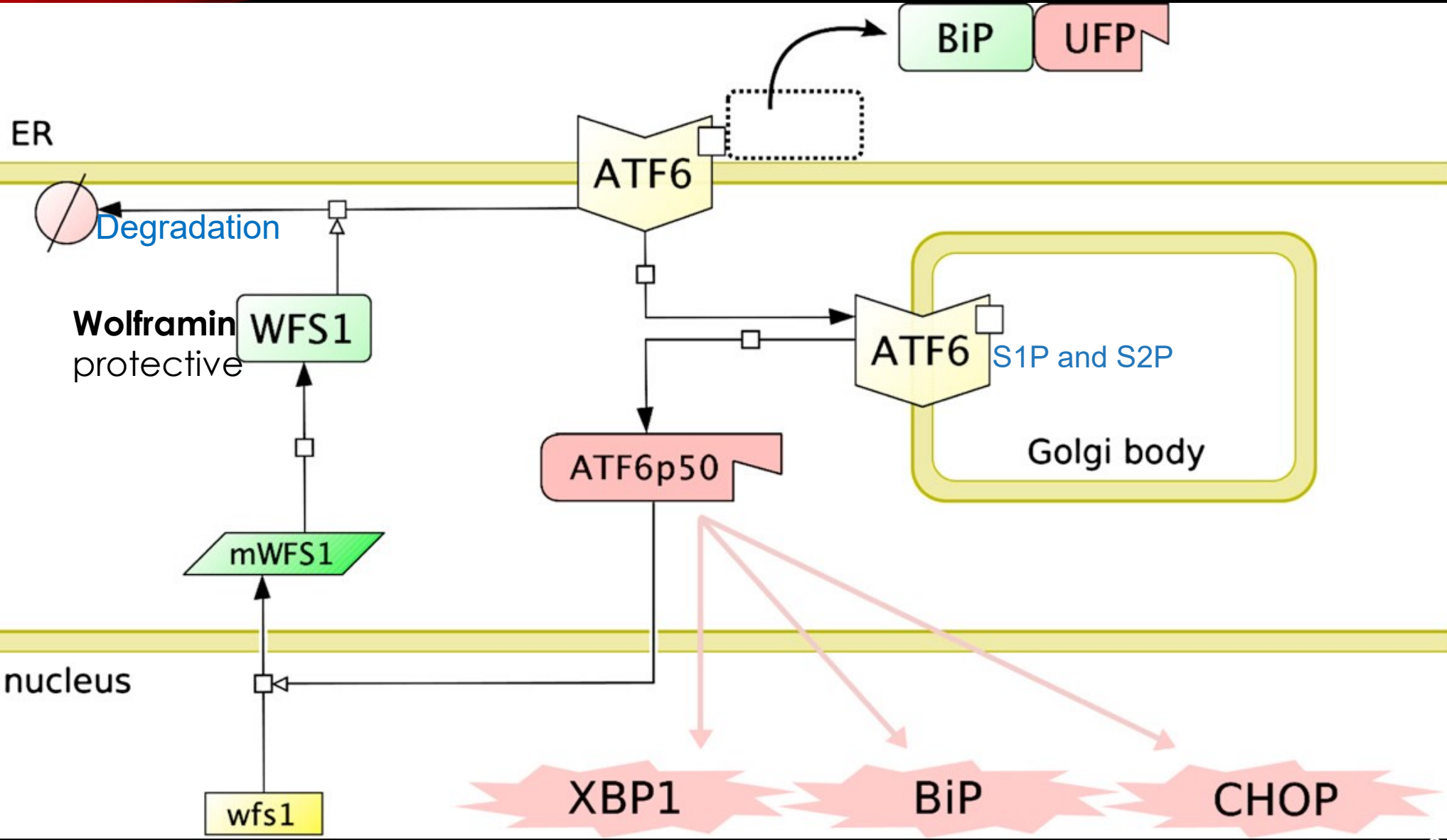

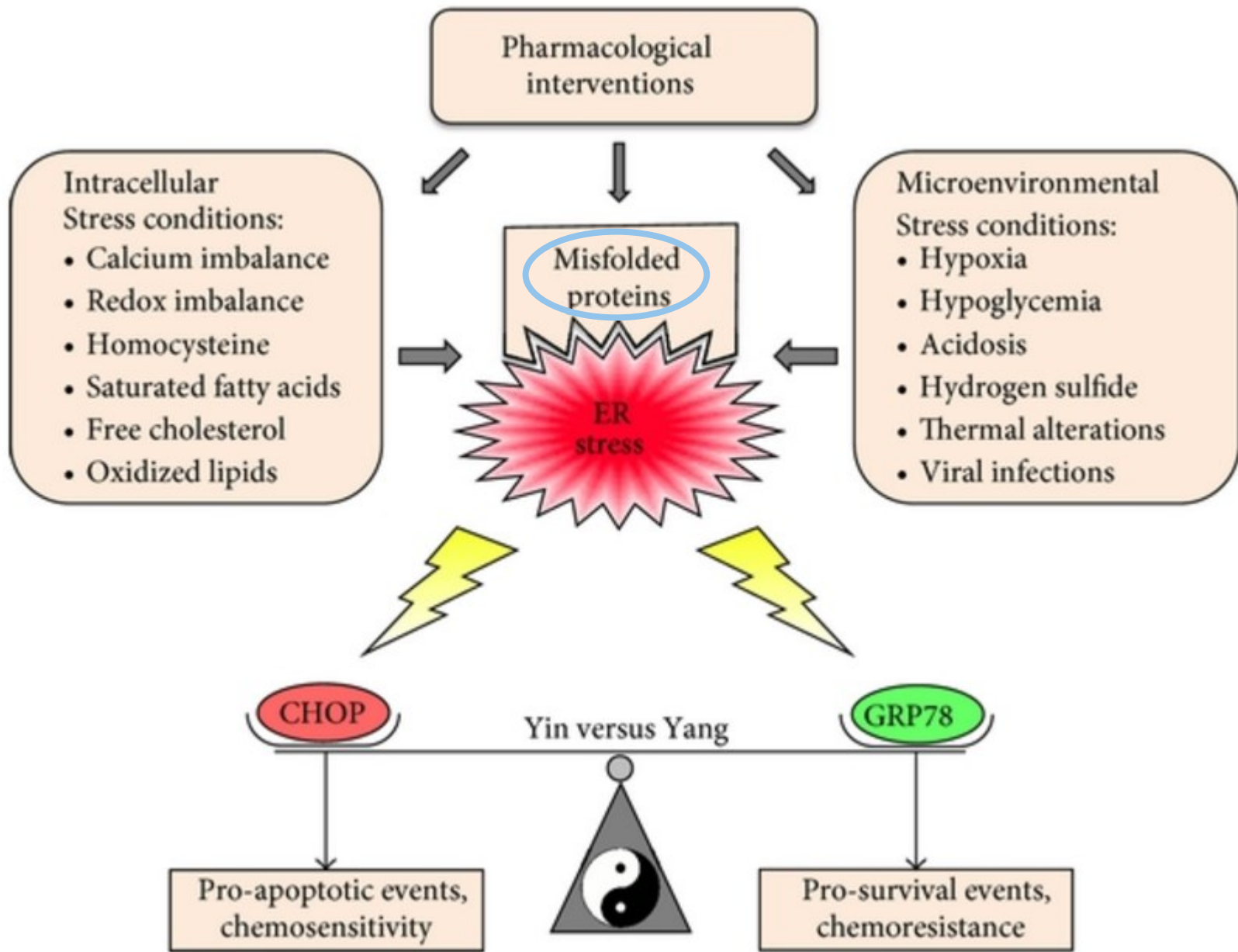

IL RECETTORE KDE4

KDELR

LUMEN

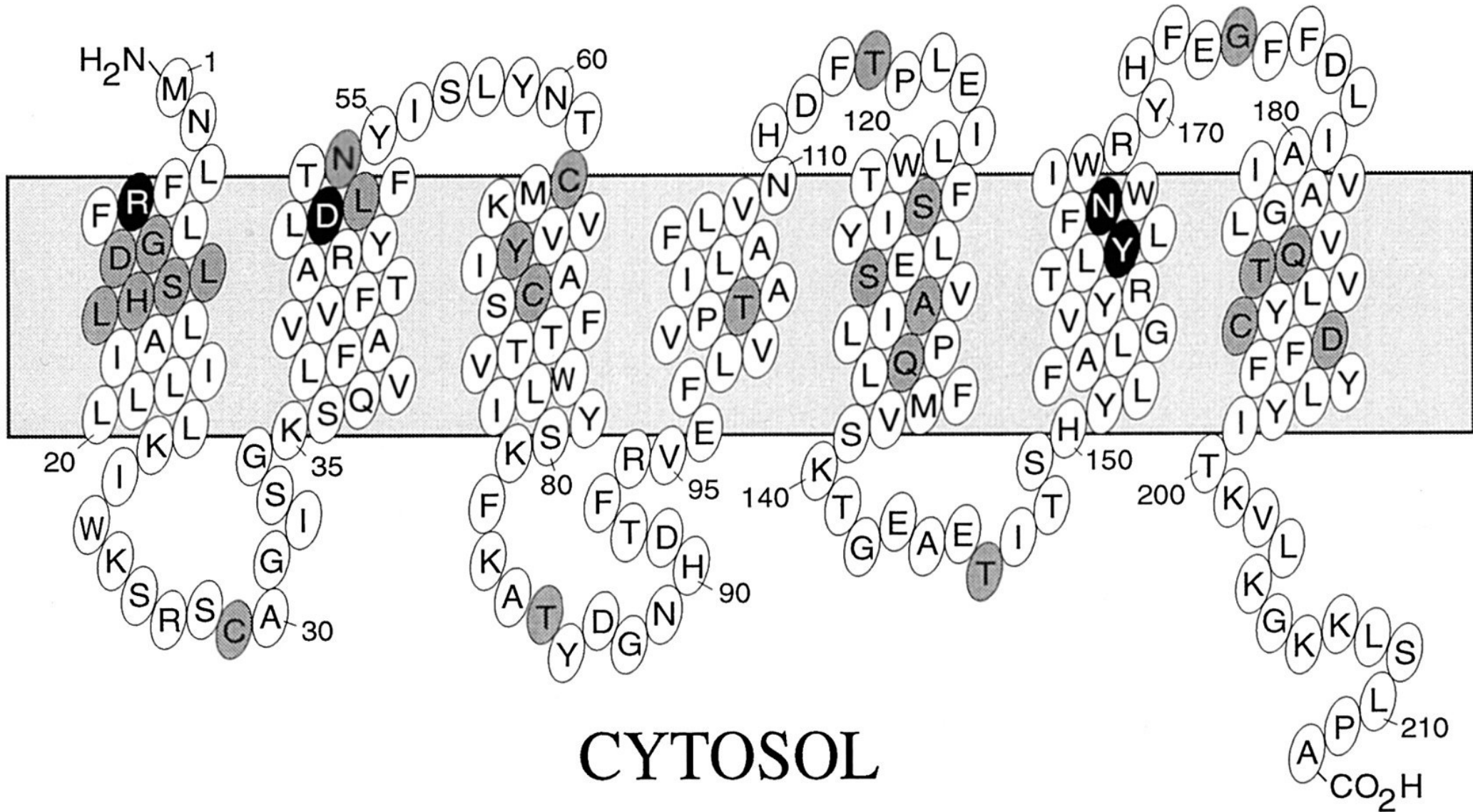

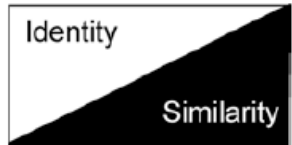

	HDEL receptor	KDEL receptor 1	KDEL receptor 2	KDEL receptor 3a	KDEL receptor 3b
HDEL receptor (Ac. No. CAA84860)		50,2% 70,3%	49,5% 68,0%	47,5% 69,7%	43,9% 65,2%
KDEL receptor 1 (Ac. No. NP_006792)	50,2% 70,3%		83,5% 93,9%	72,0% 86,0%	65,5% 79,5%
KDEL receptor 2 (Ac. No. NP_006845)	49,5% 68,0%	83,5% 93,9%		75,7% 87,9%	69,1% 81,4%
KDEL receptor 3a (Ac. No. NP_006846)	47,5% 69,7%	72,0% 86,0%	75,7% 87,9%		91,4% 92,3%
KDEL receptor 3b (Ac. No. NP_057839)	43,9% 65,2%	65,5% 79,5%	69,1% 81,4%	91,4% 92,3%	

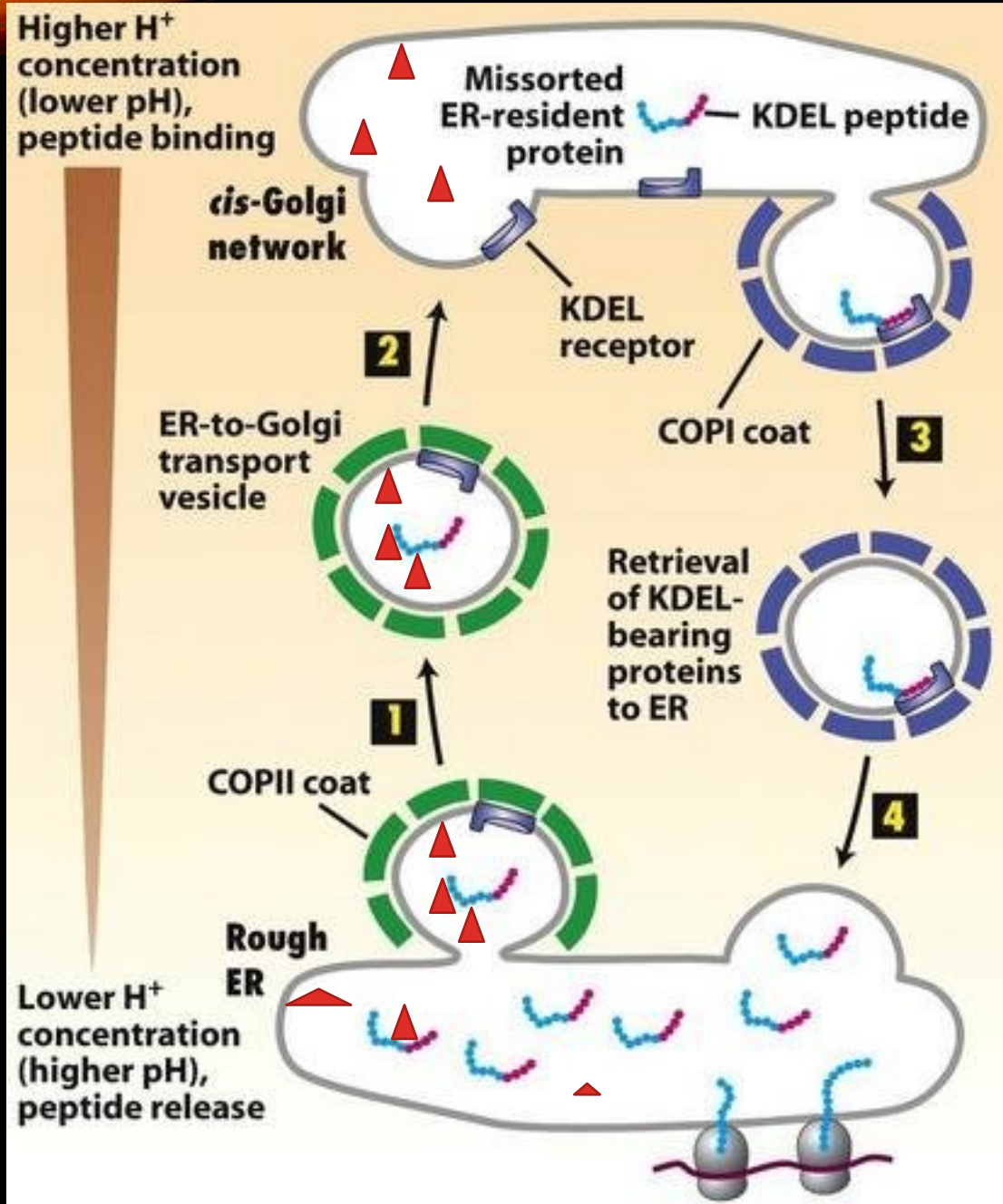

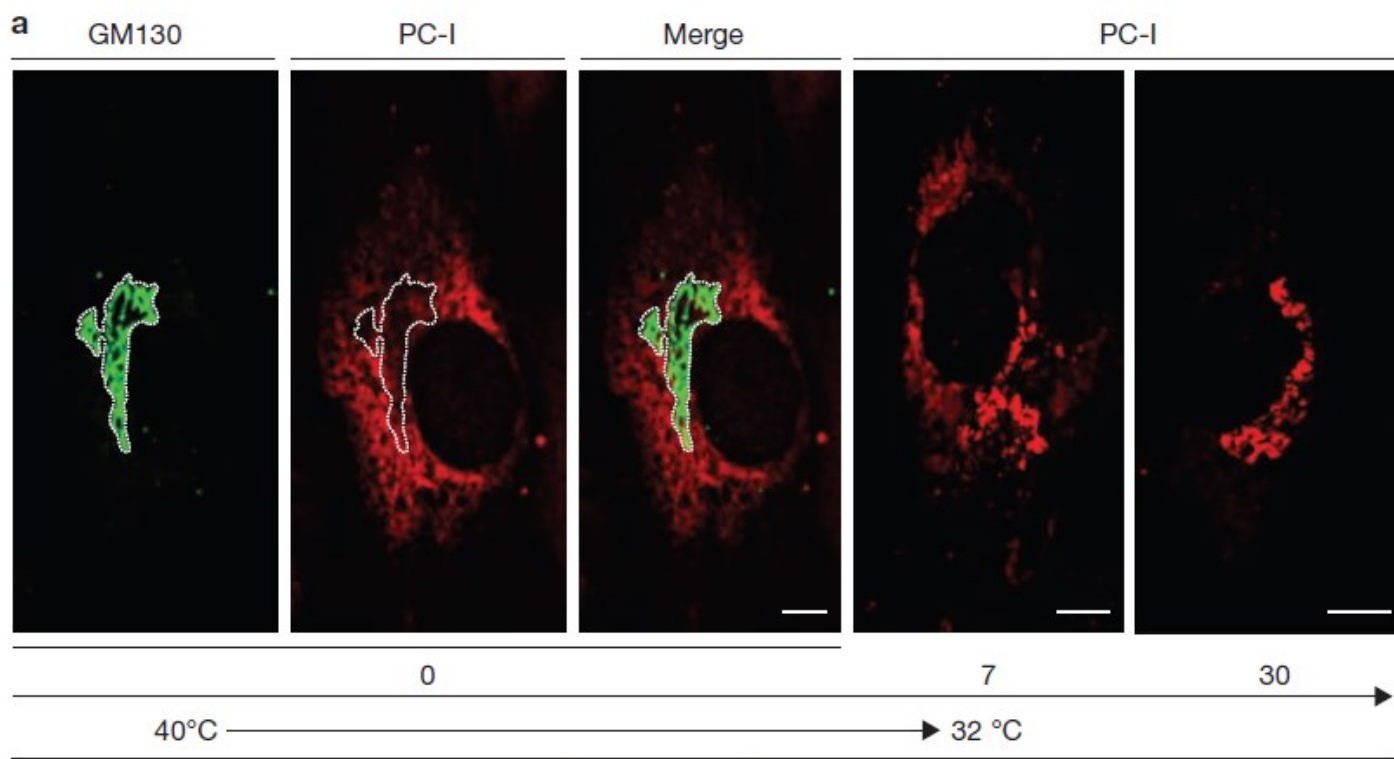

Time at 32 °C (min)

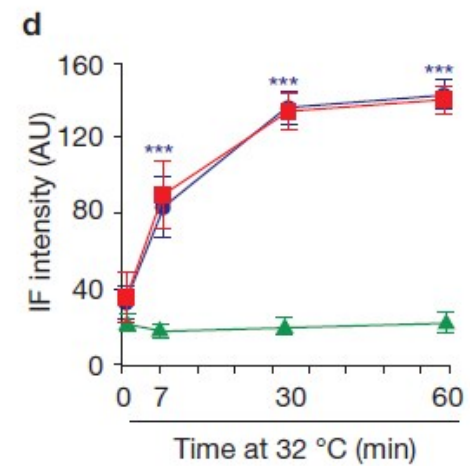
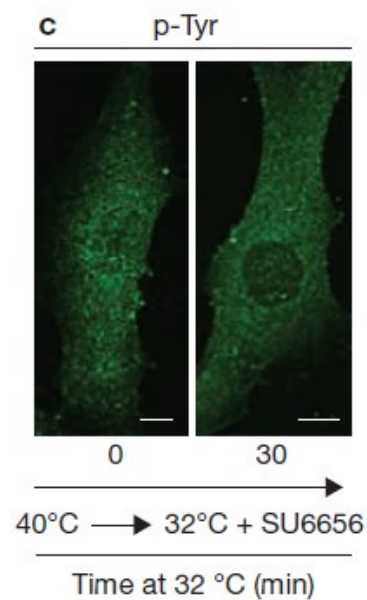
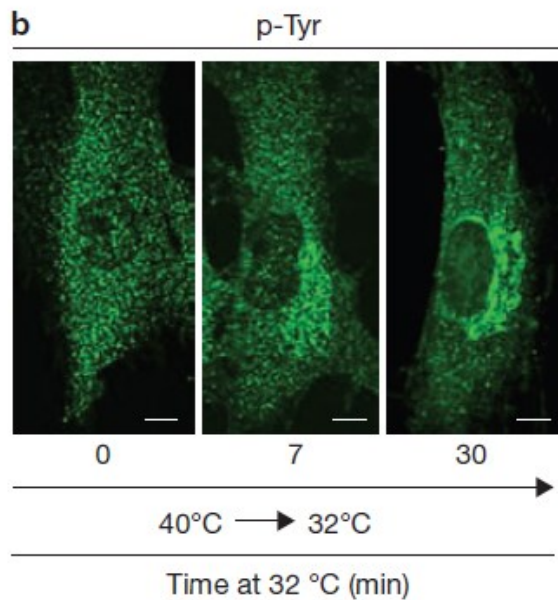

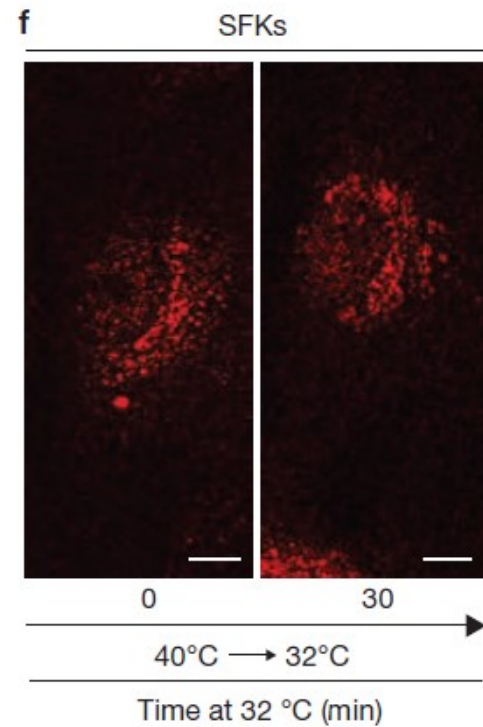
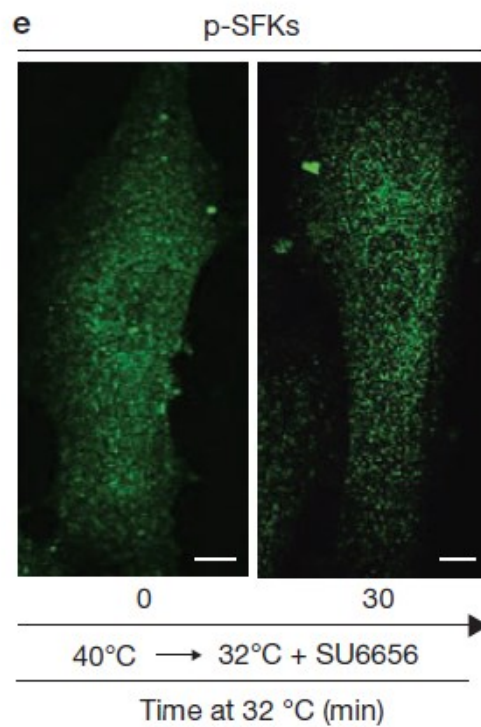
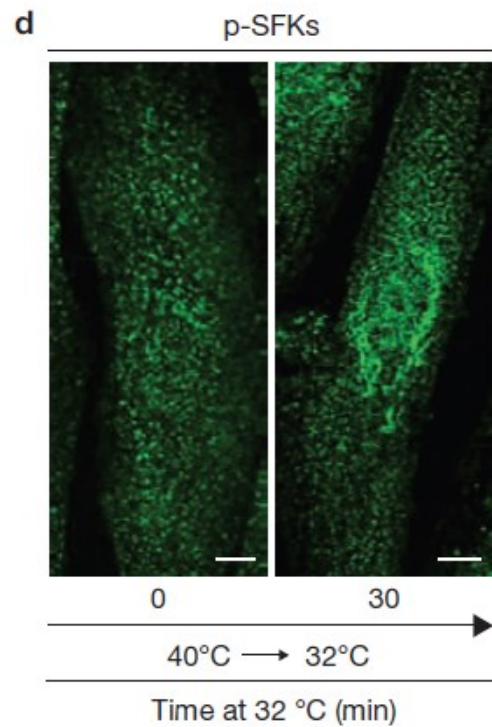
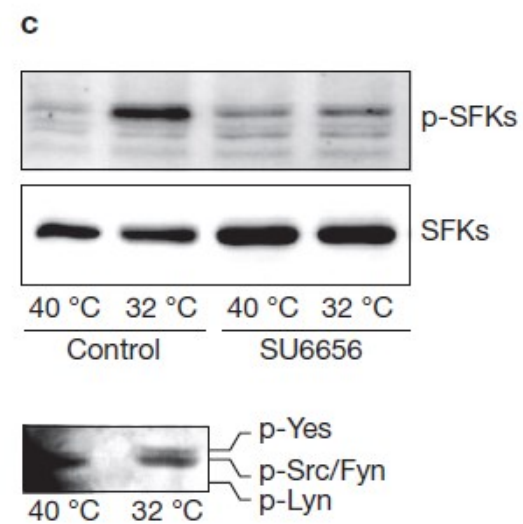
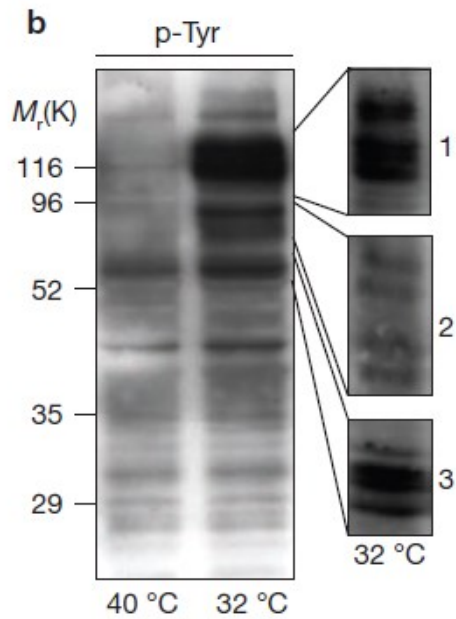
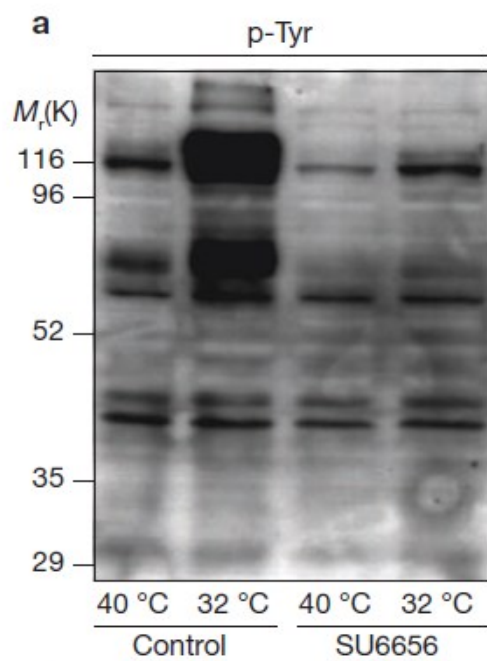

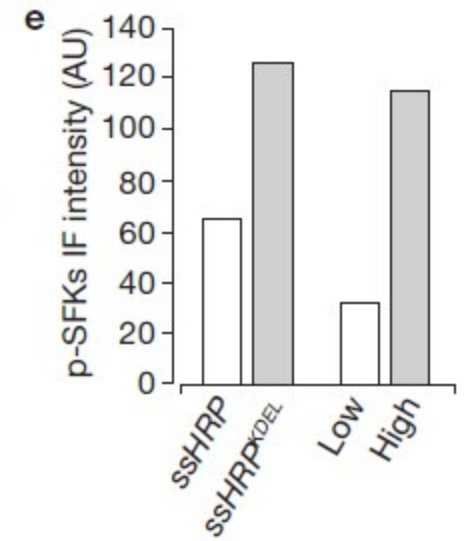
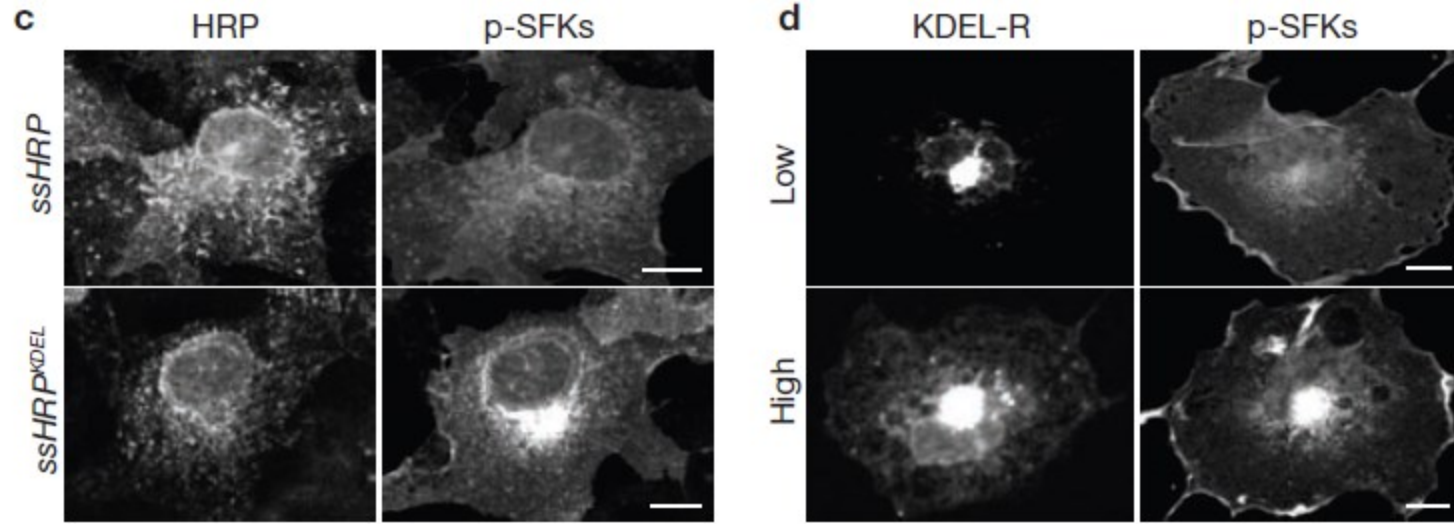

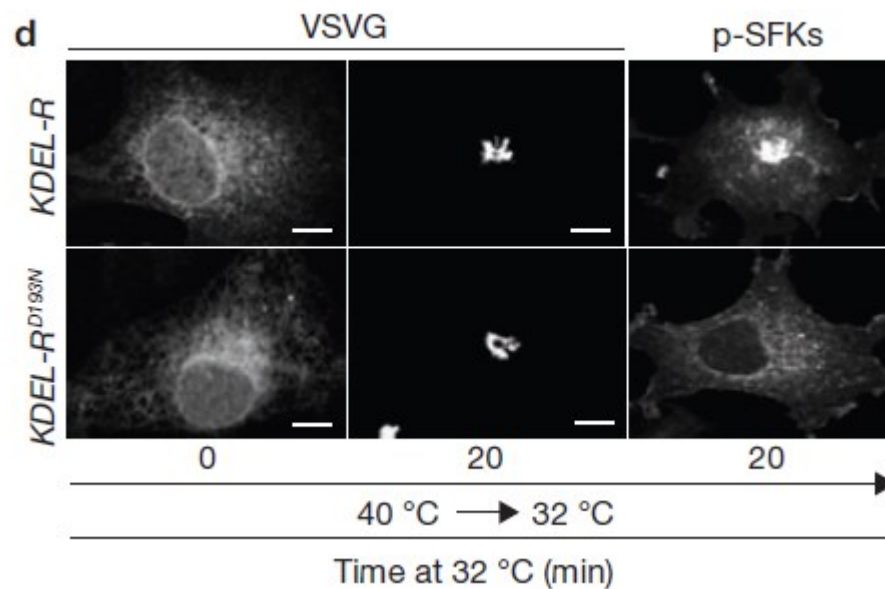
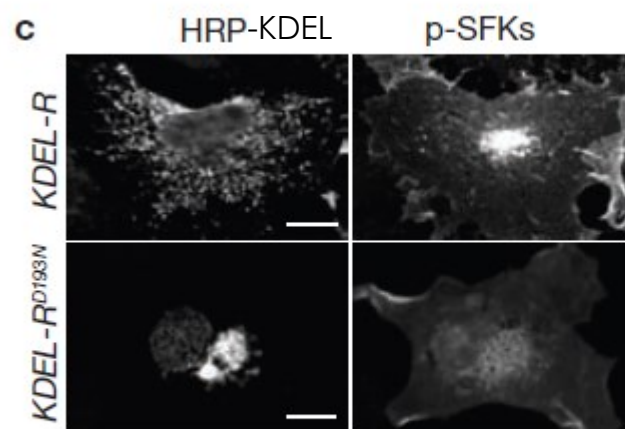
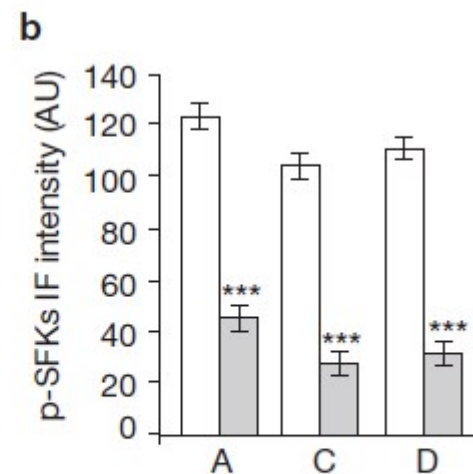
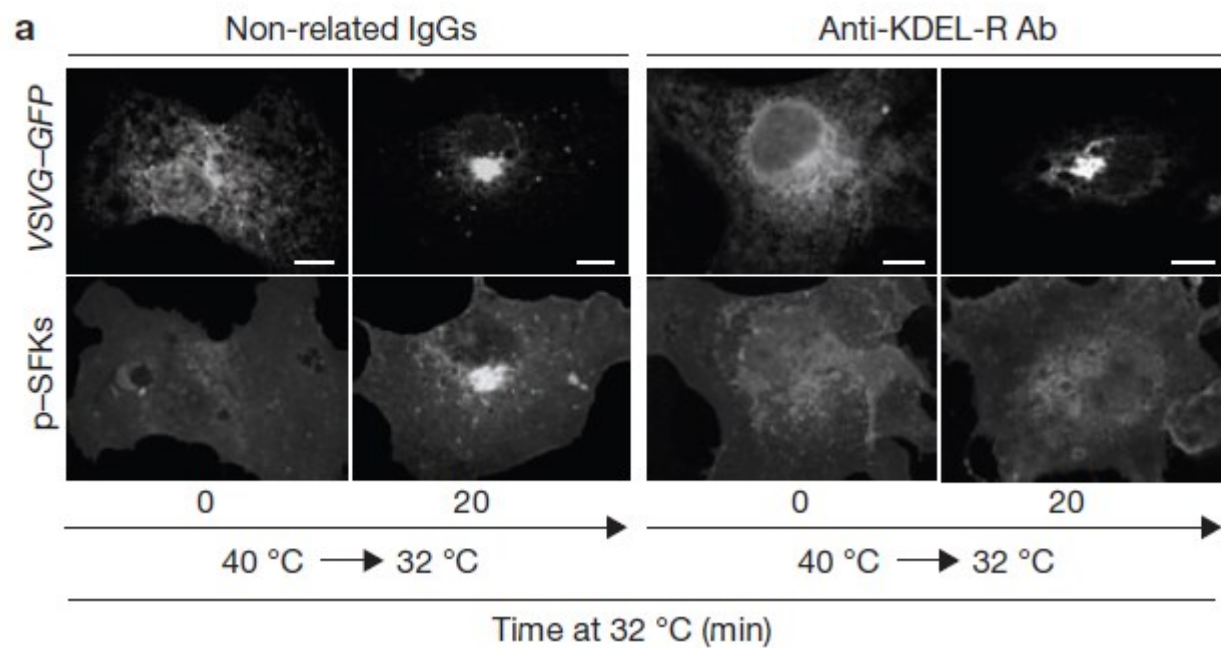

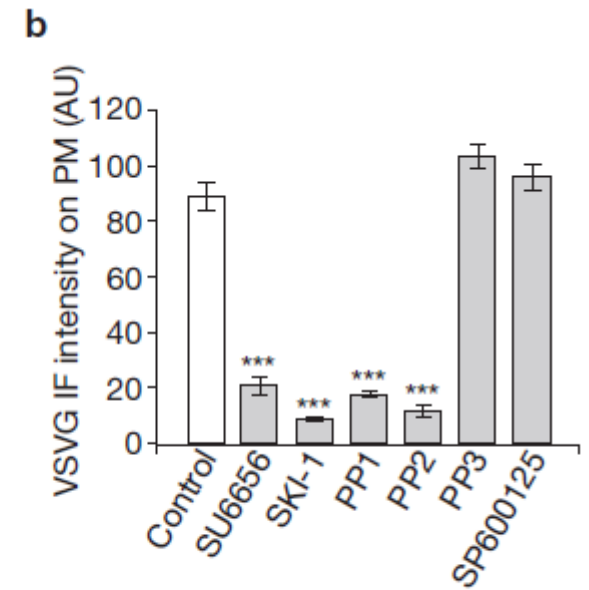
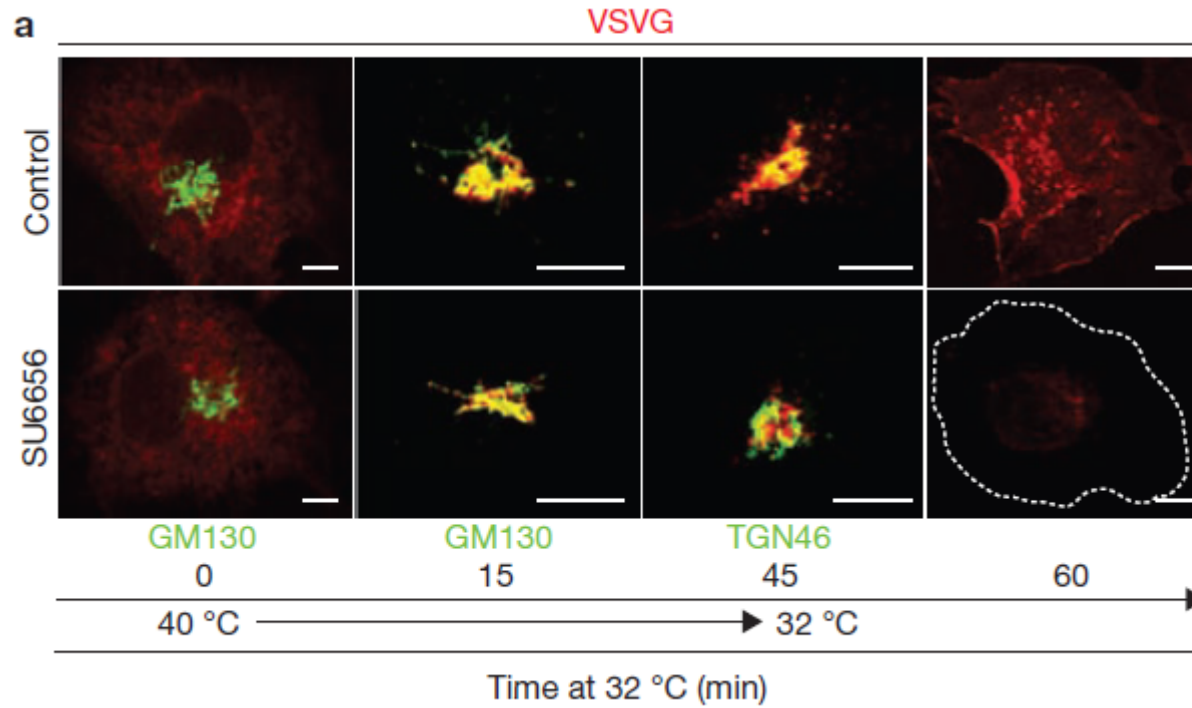

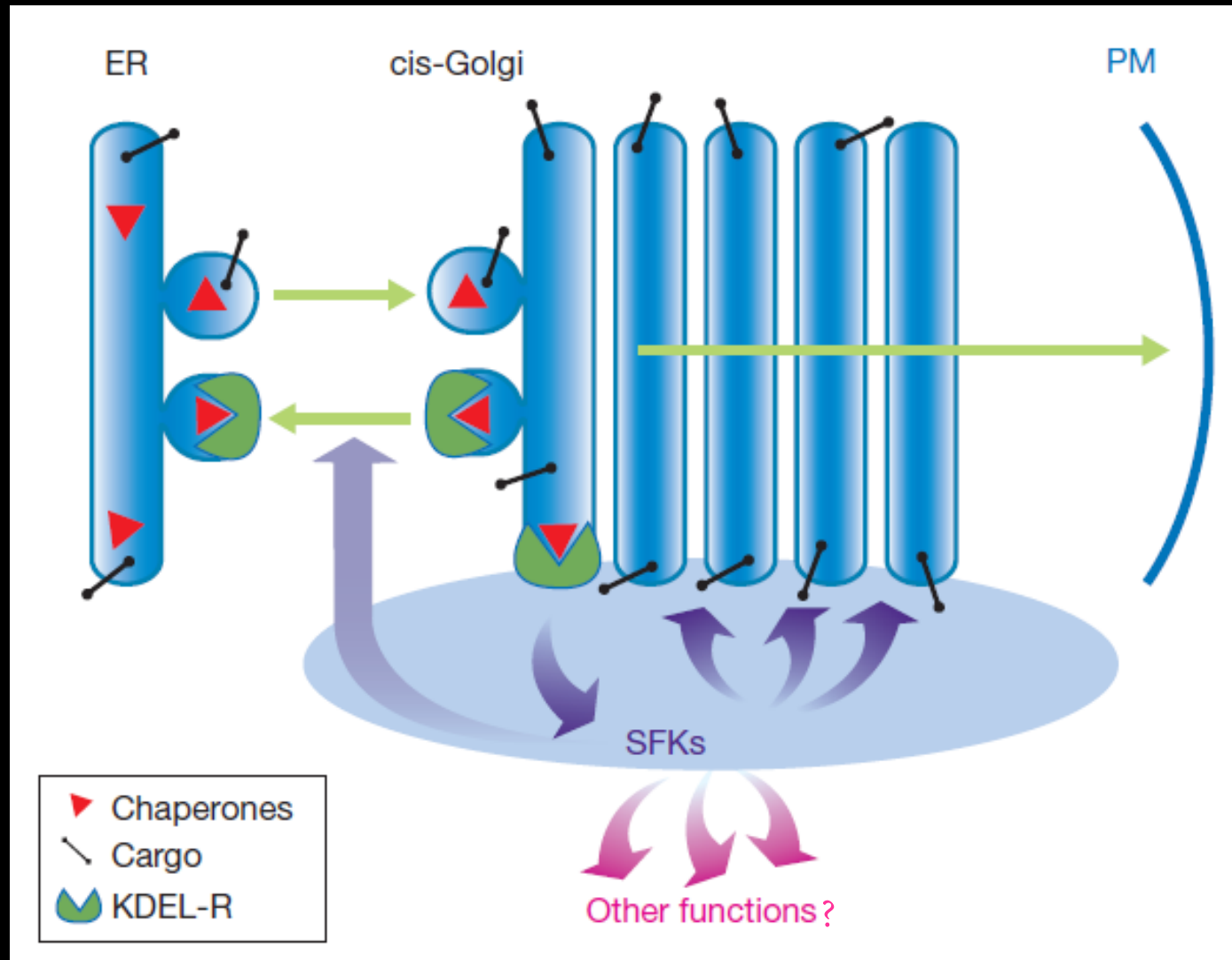

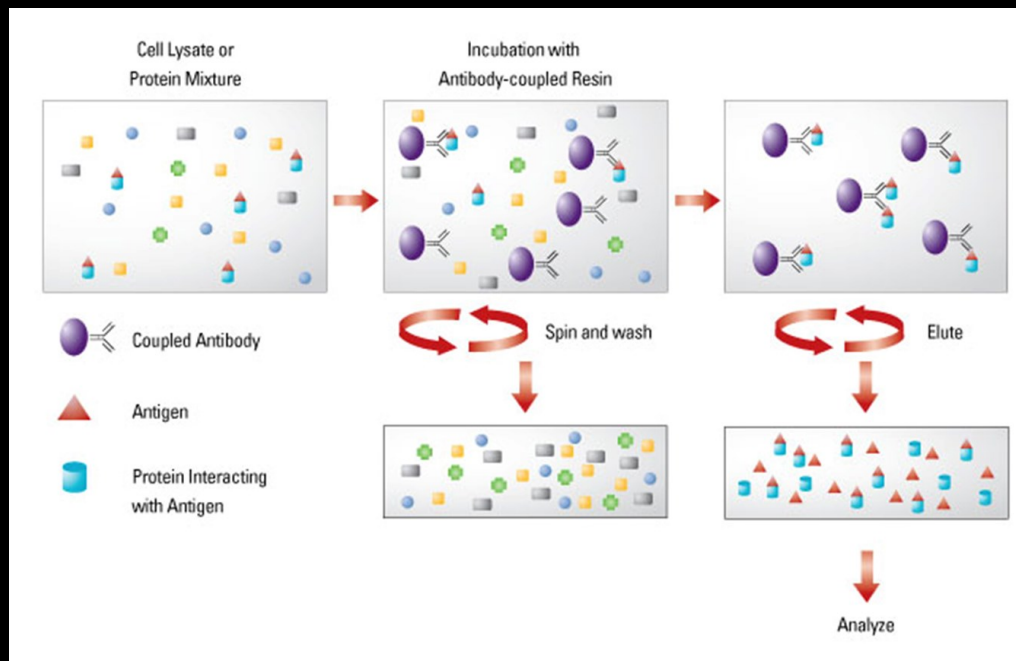
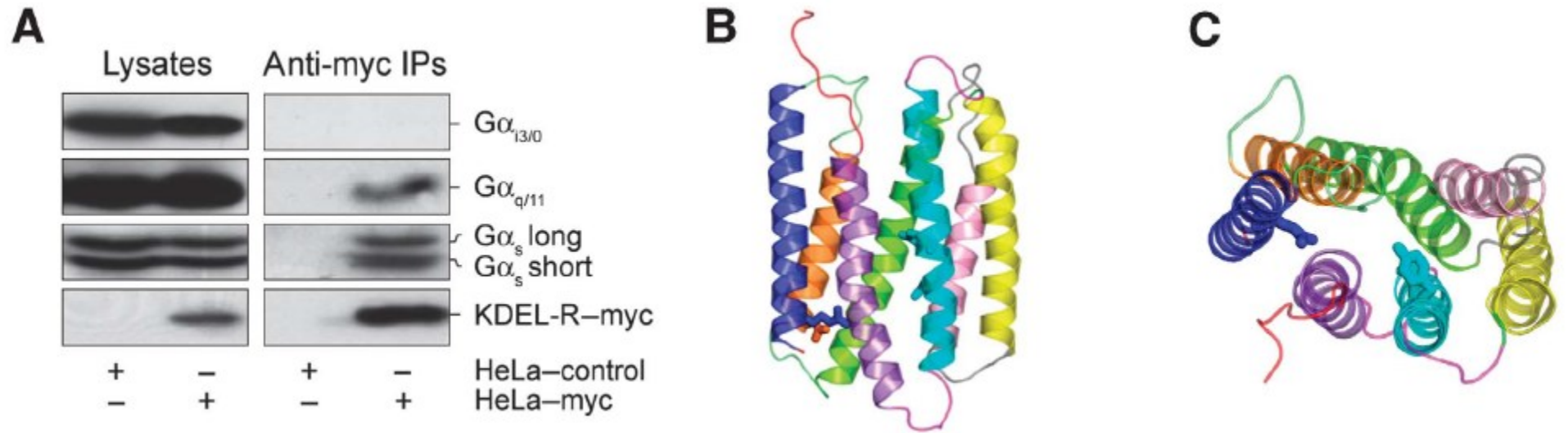

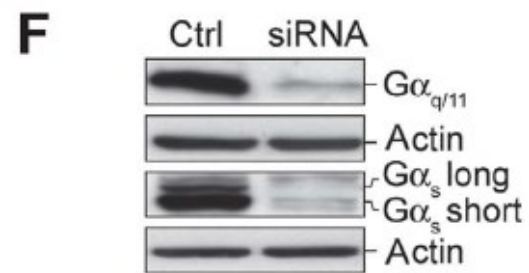
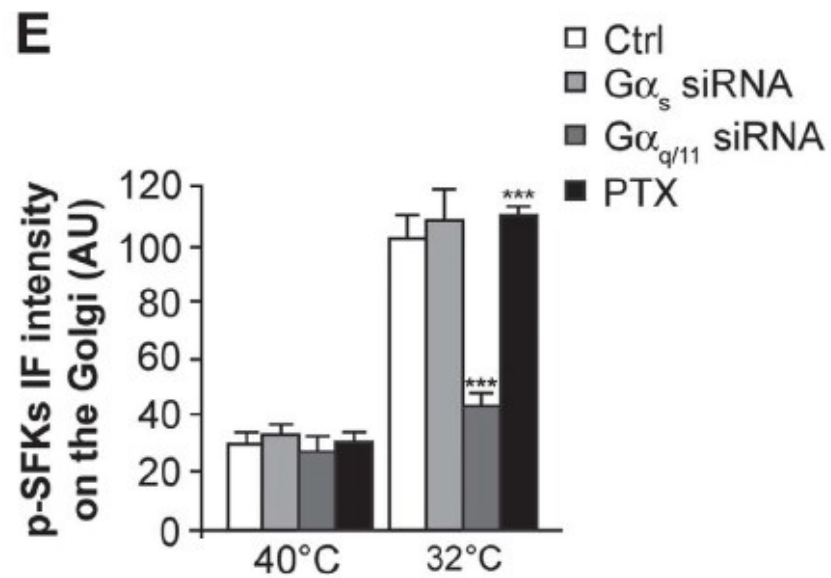
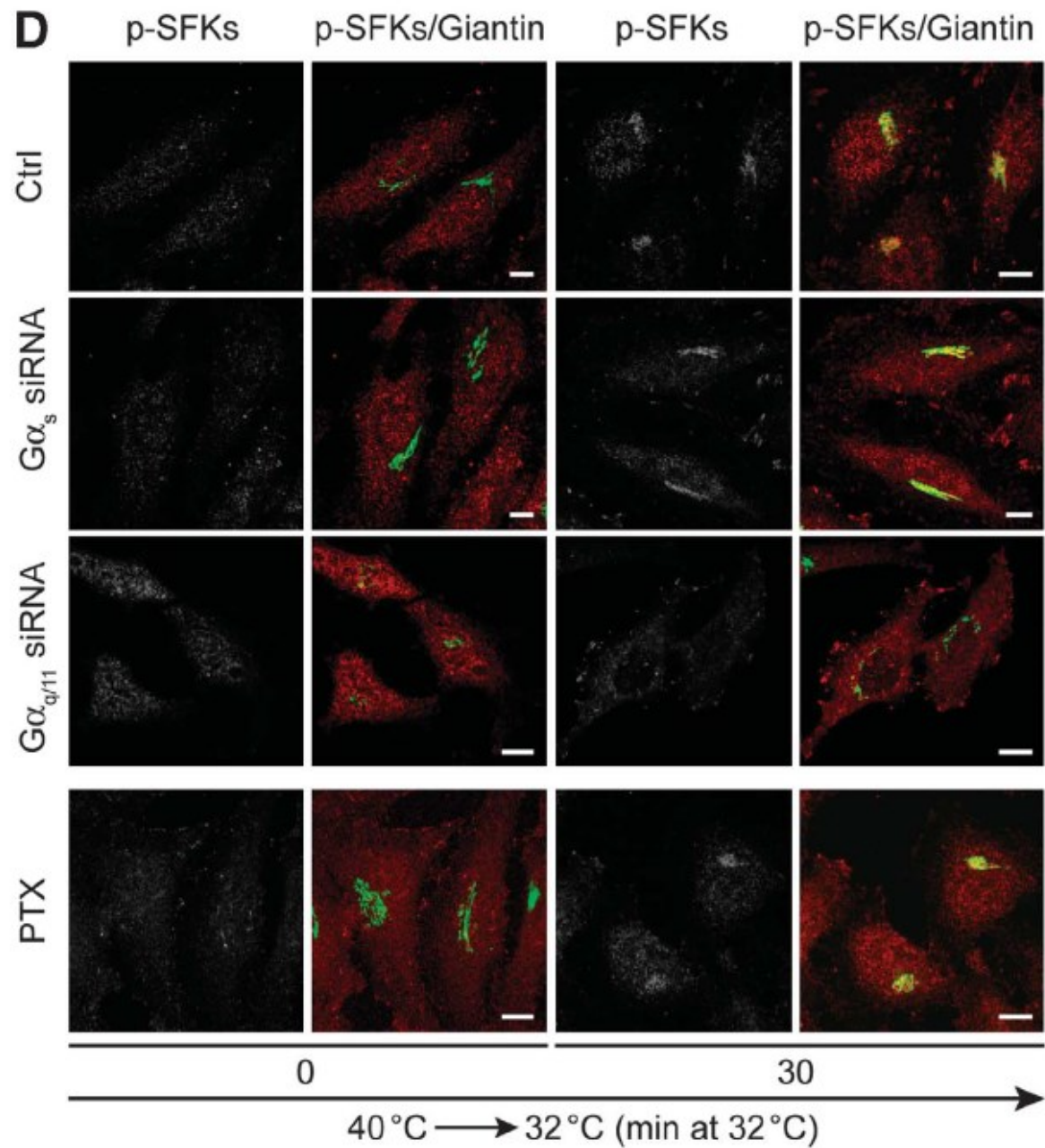

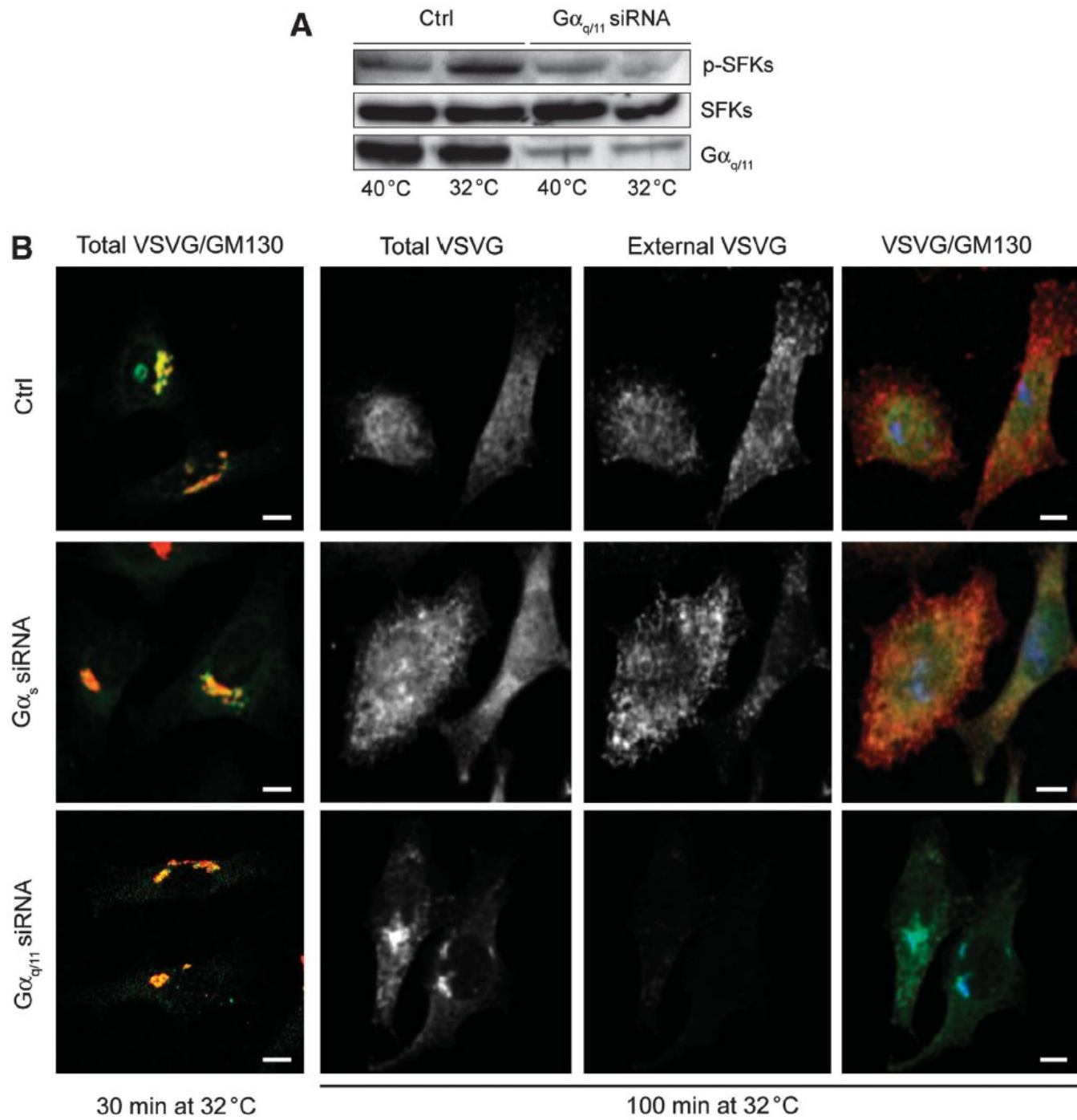

A

GRK2-RGS-GFP

GRK2-RGS-GFP/GM130

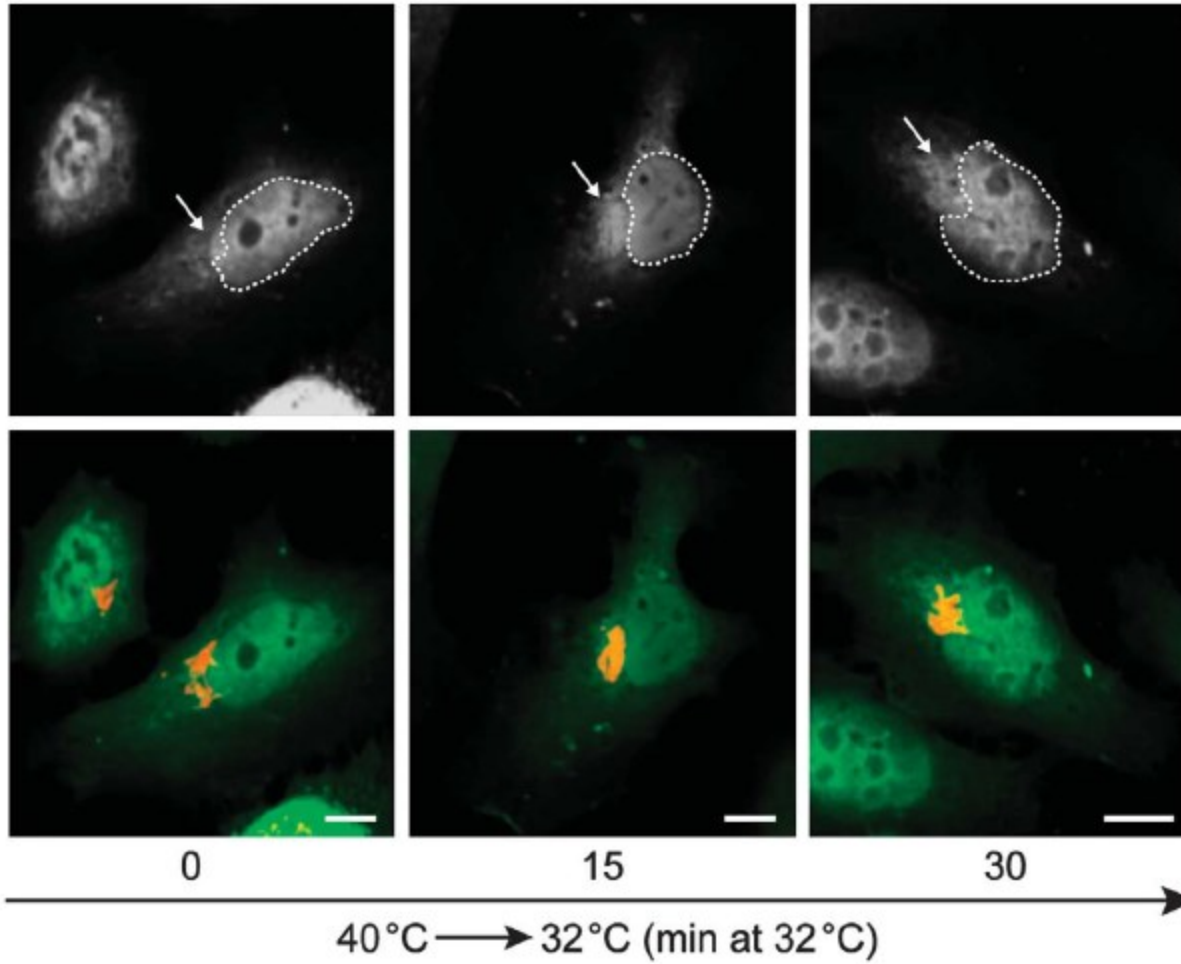
**B**

Relative intensity
(IF GRK2-RGS-GFP [Golgi/cytosol])

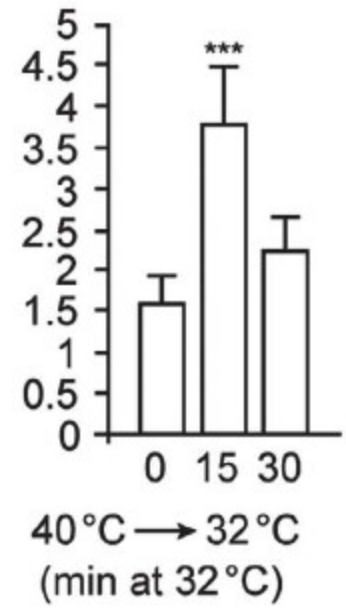

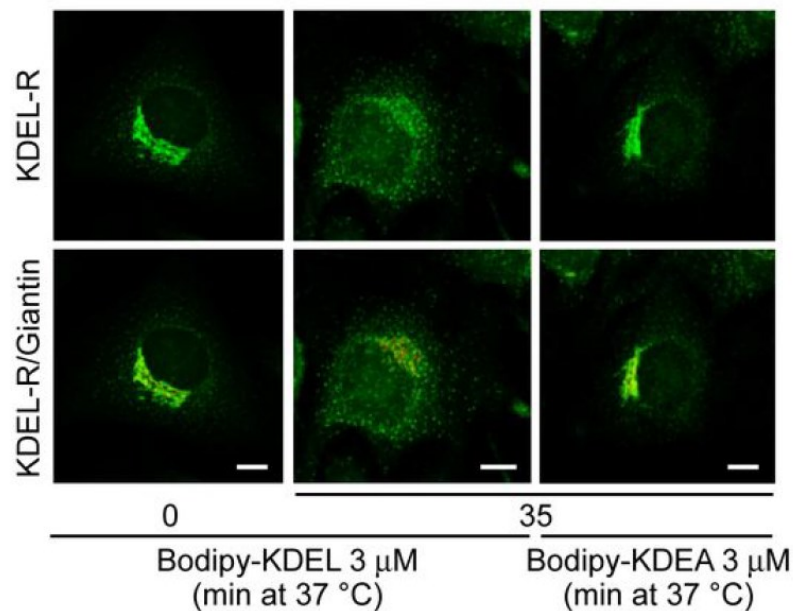
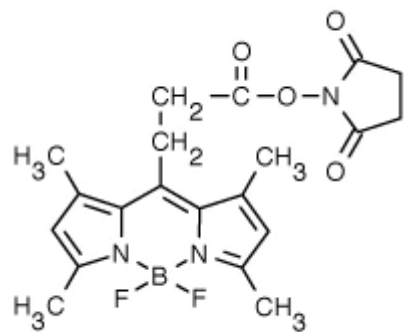

B

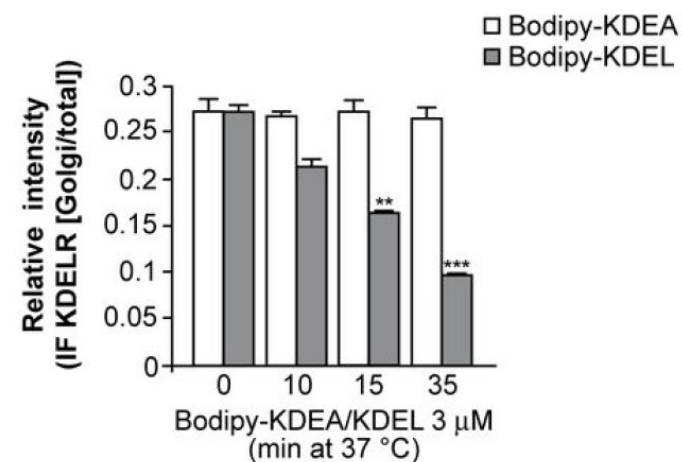

C

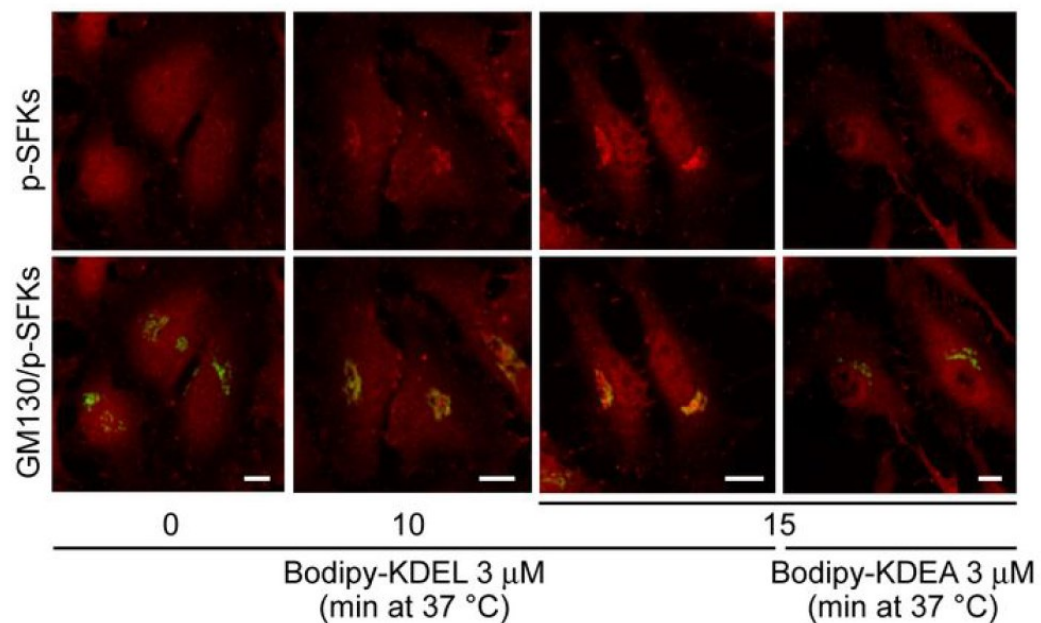

D

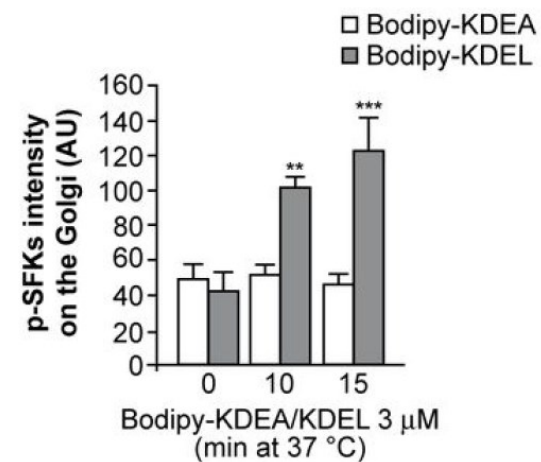

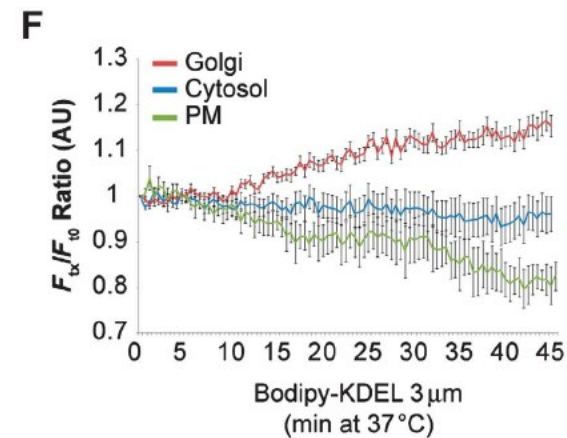
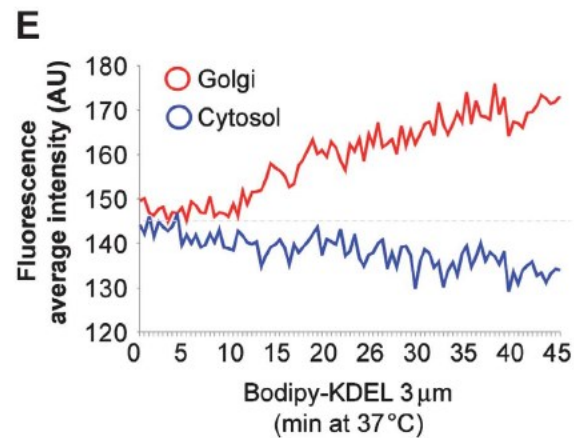
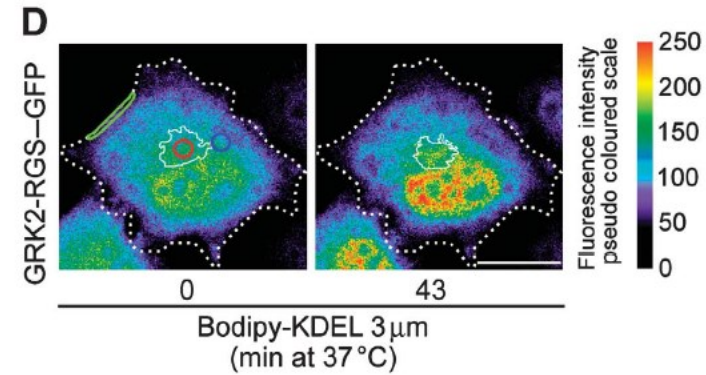
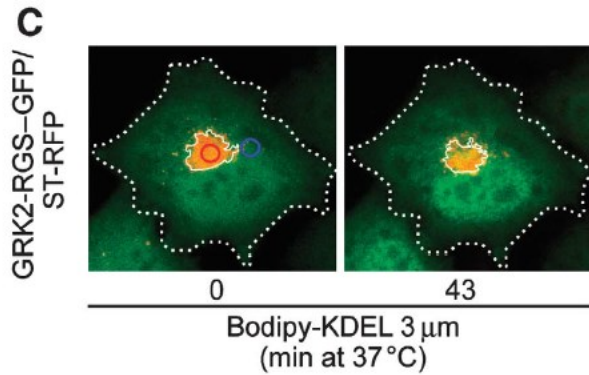
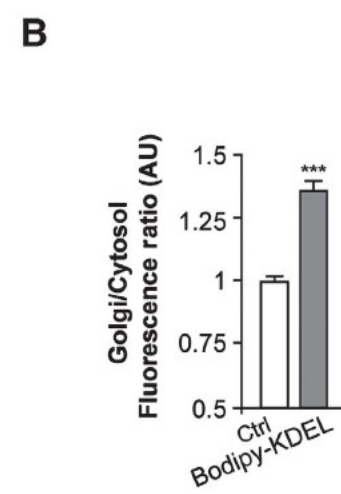
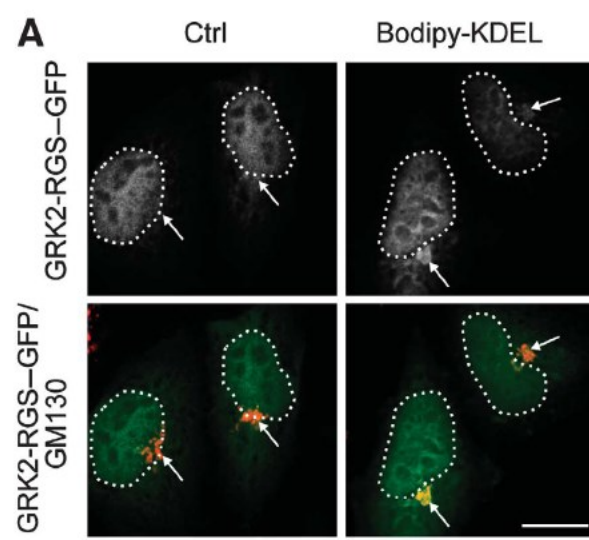

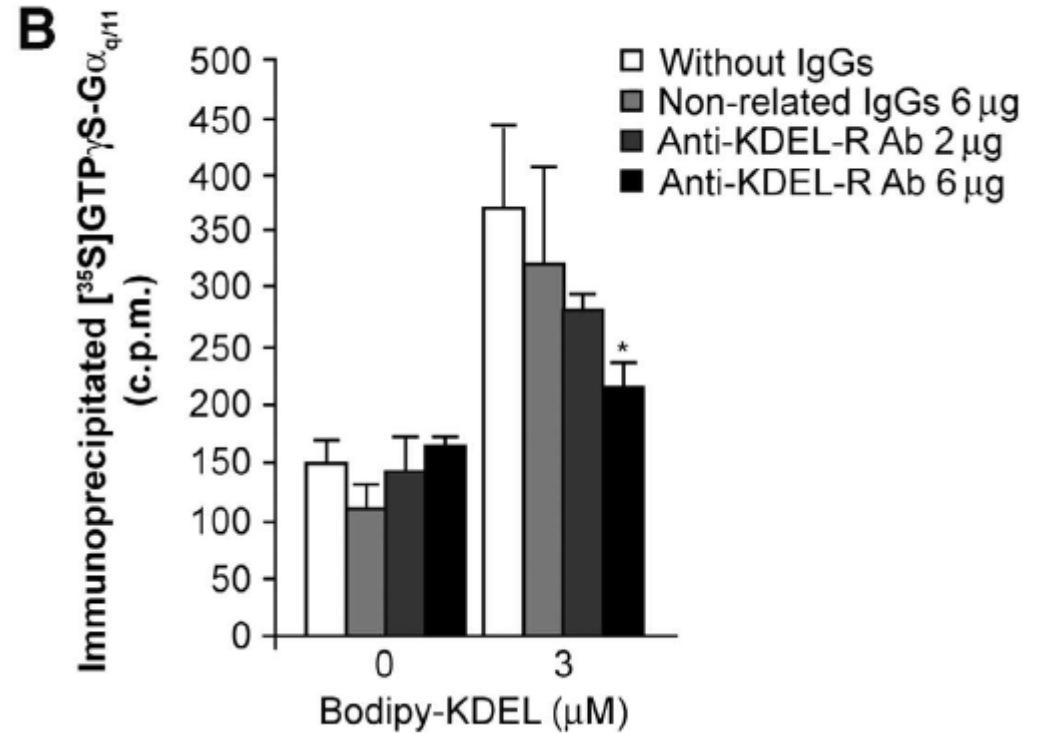
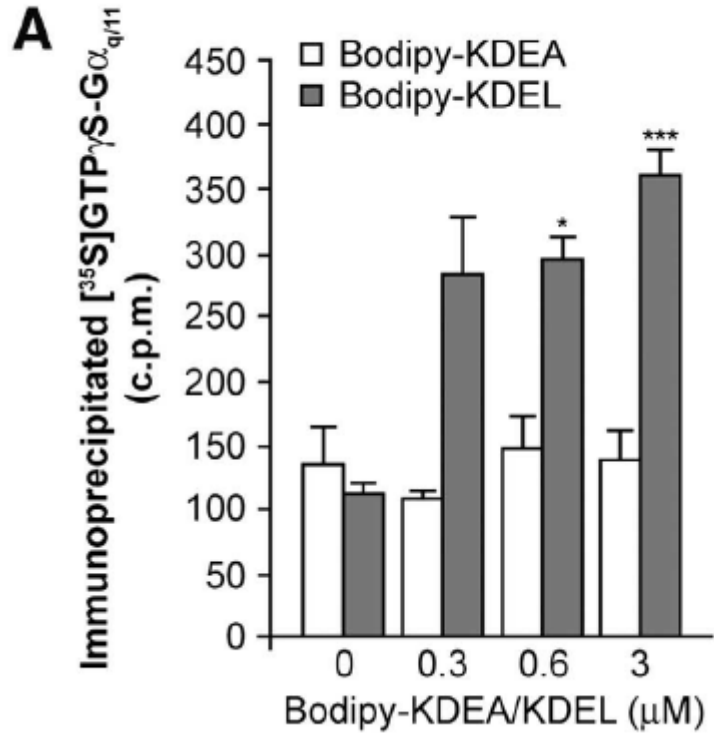

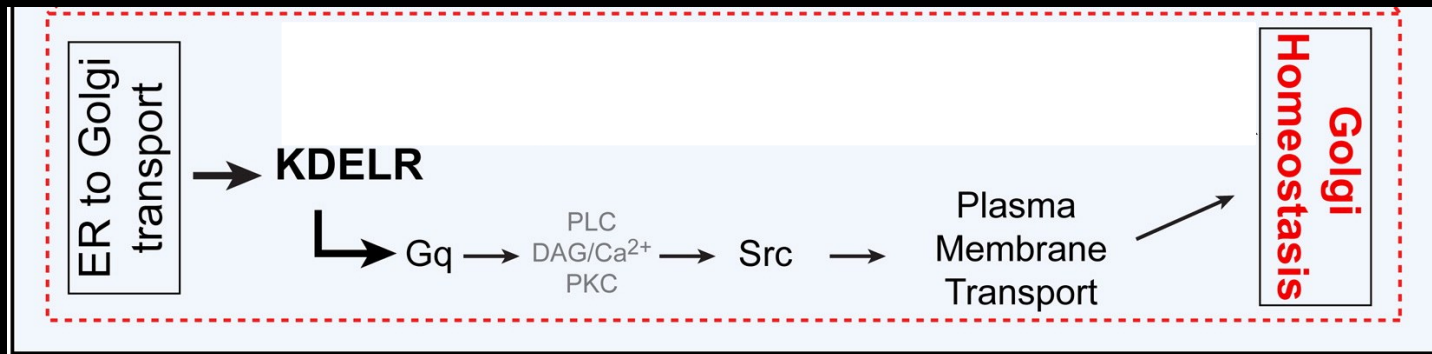

A

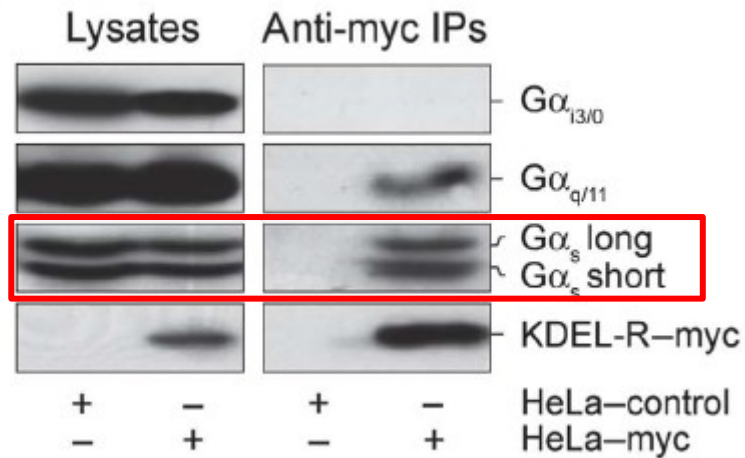

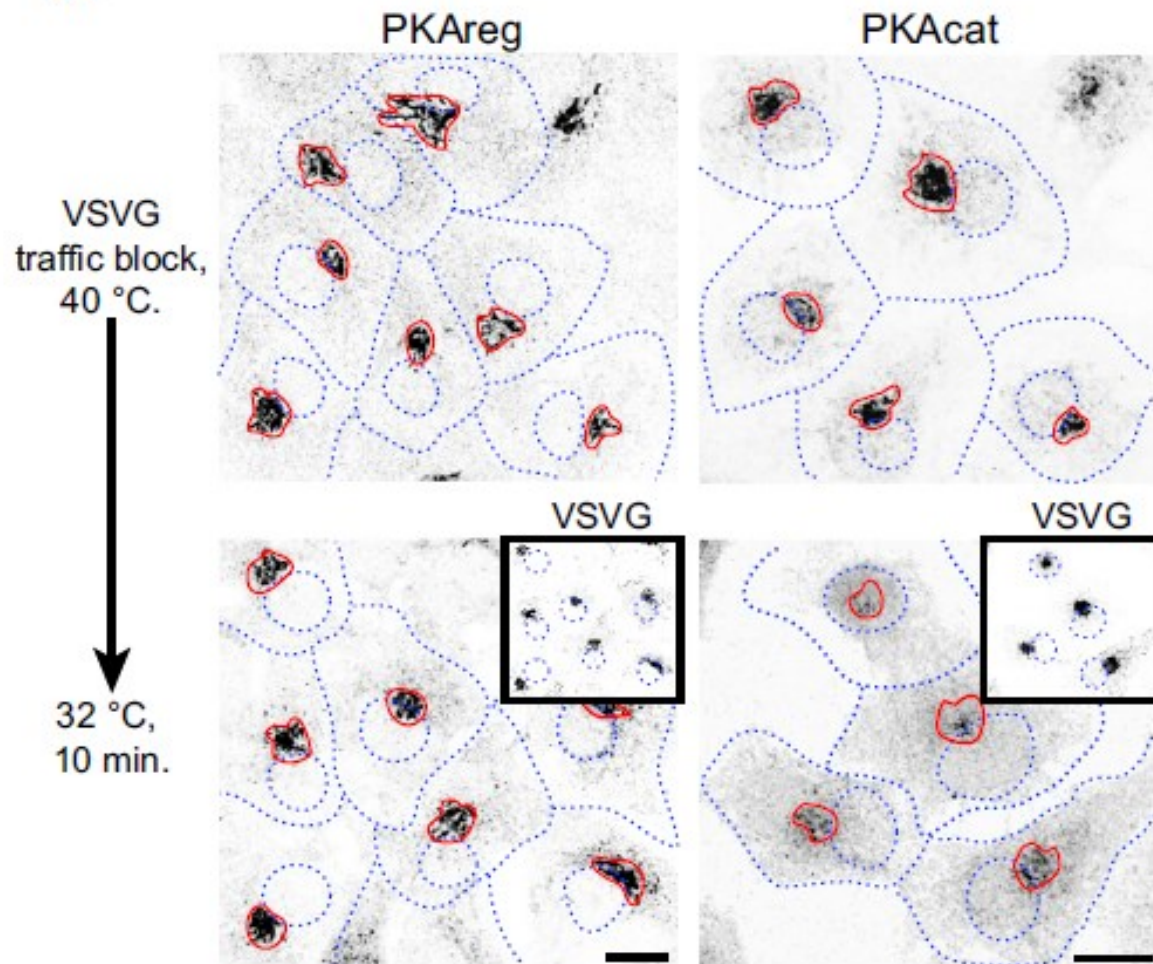
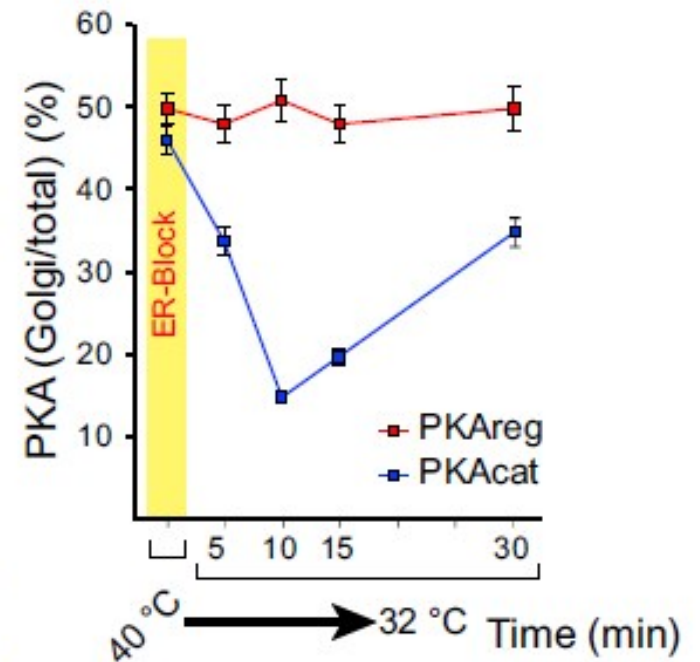
A**B**

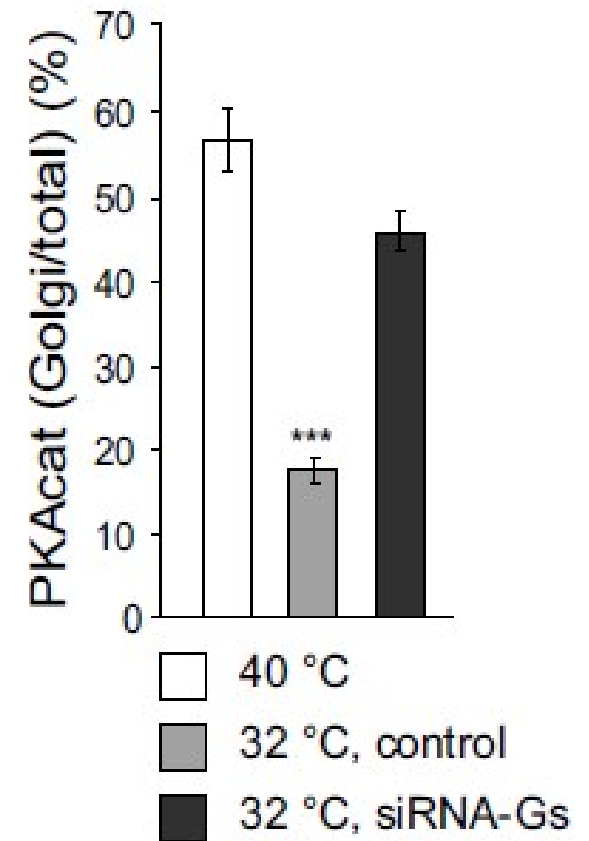
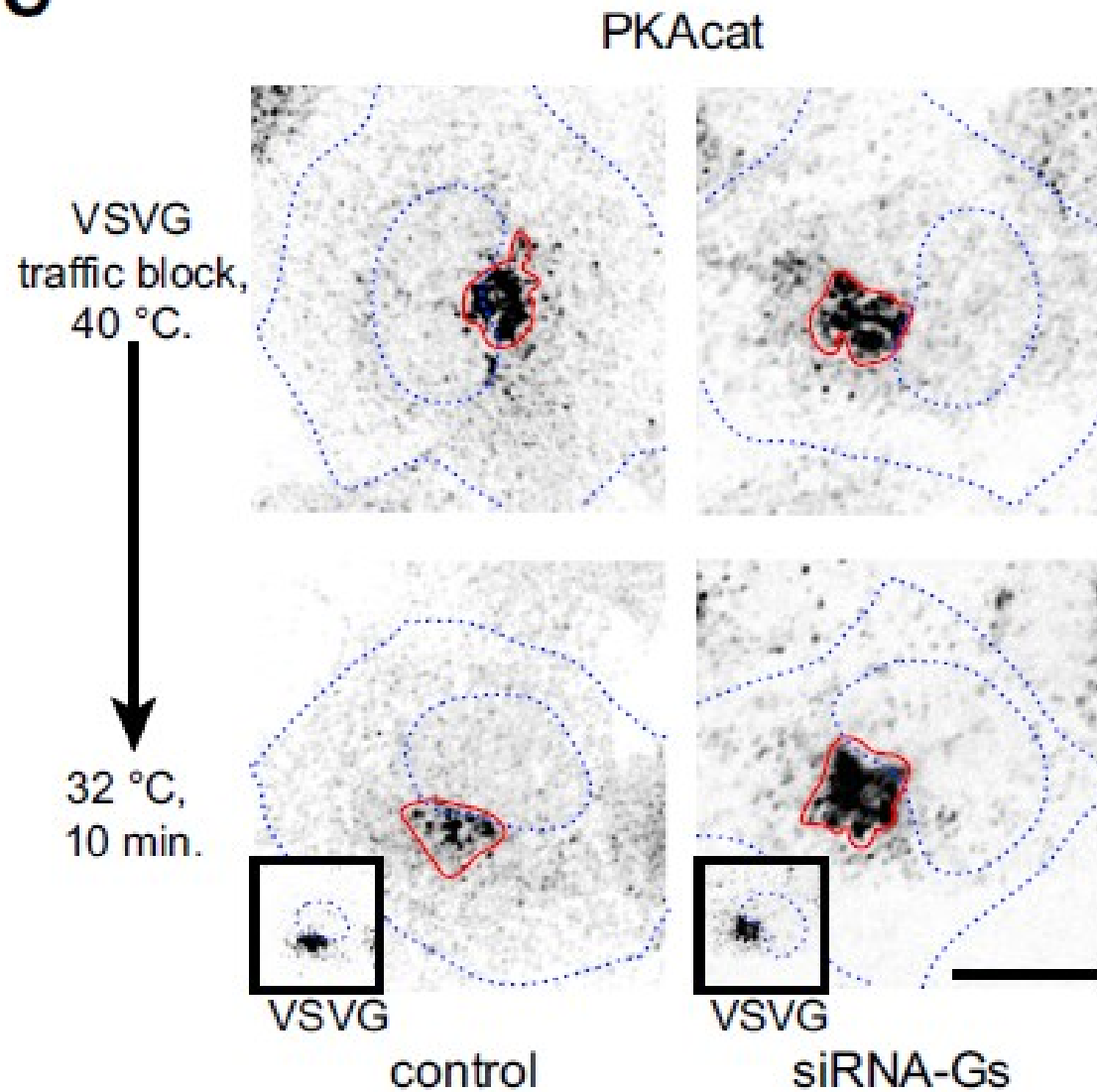
C

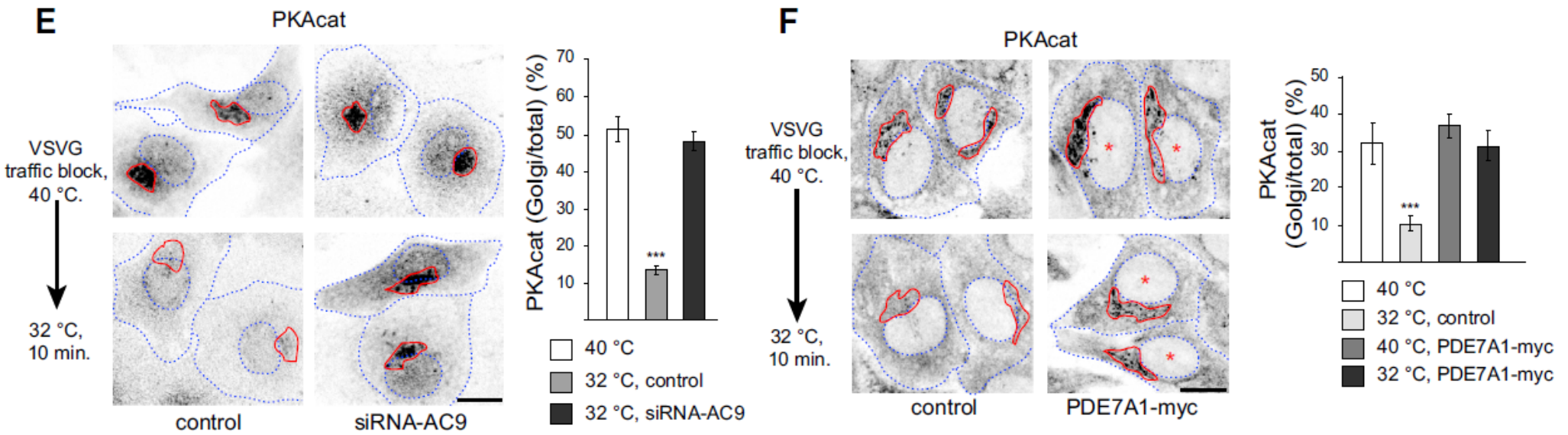

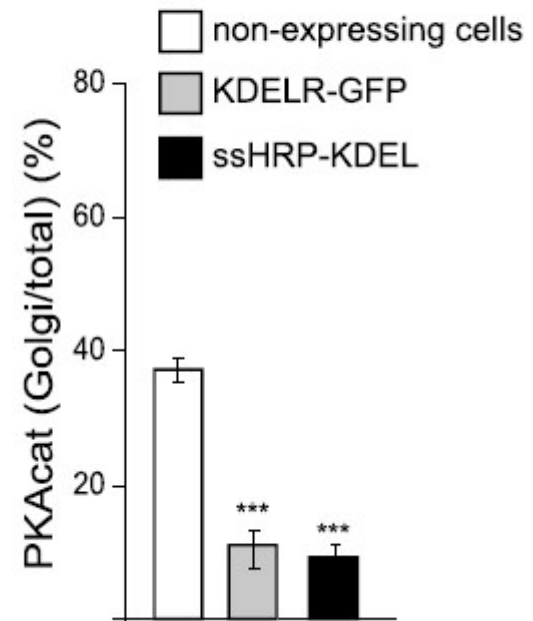
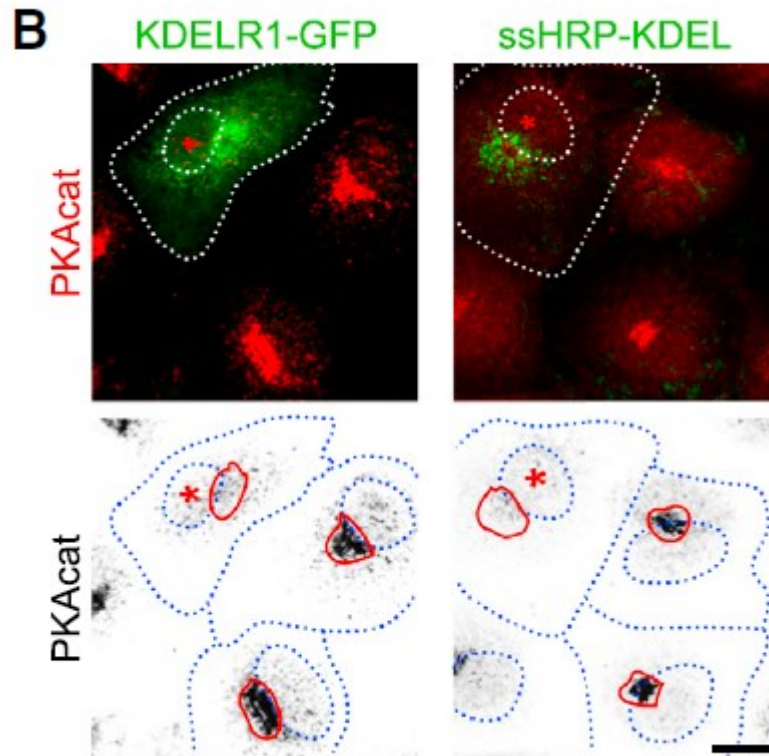

C

PKAcac

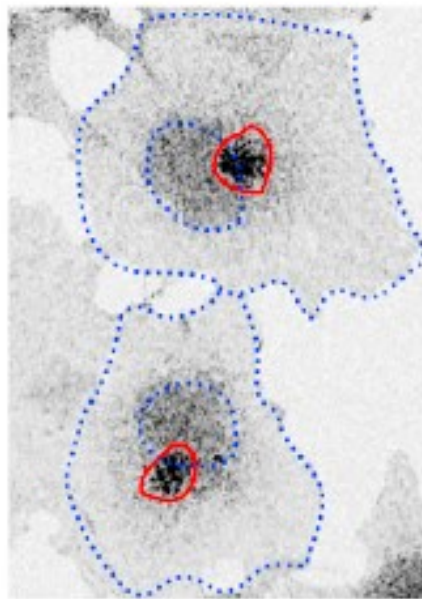

Control

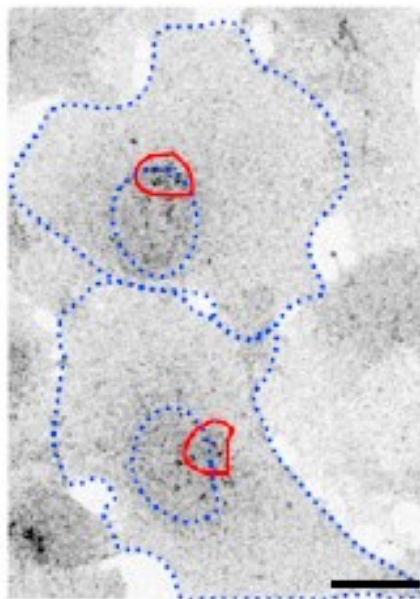
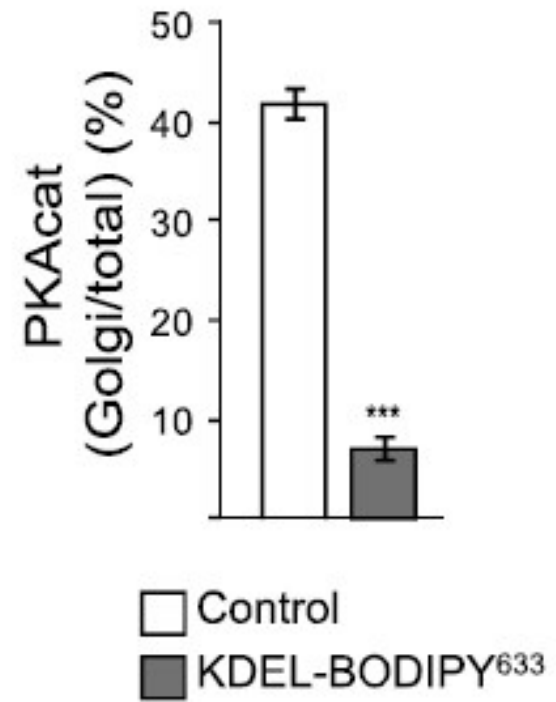
KDEL-BODIPY⁶³³
1 μ M

D

□ KDEA-BODIPY⁵⁶⁸
■ KDEL-BODIPY⁵⁶⁸

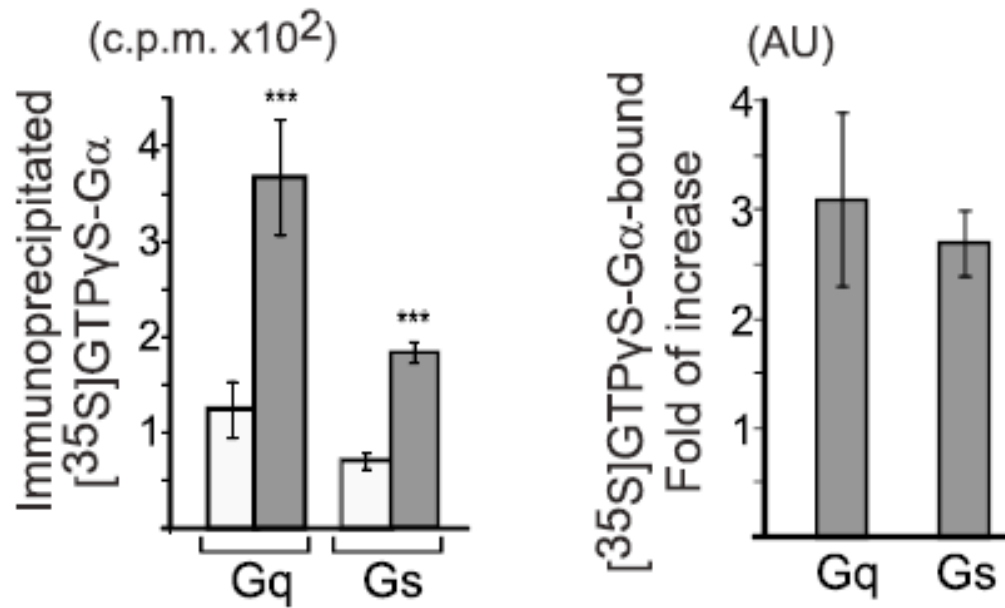



RUOLO DEL SIGNALING KDELR-G_{αS}

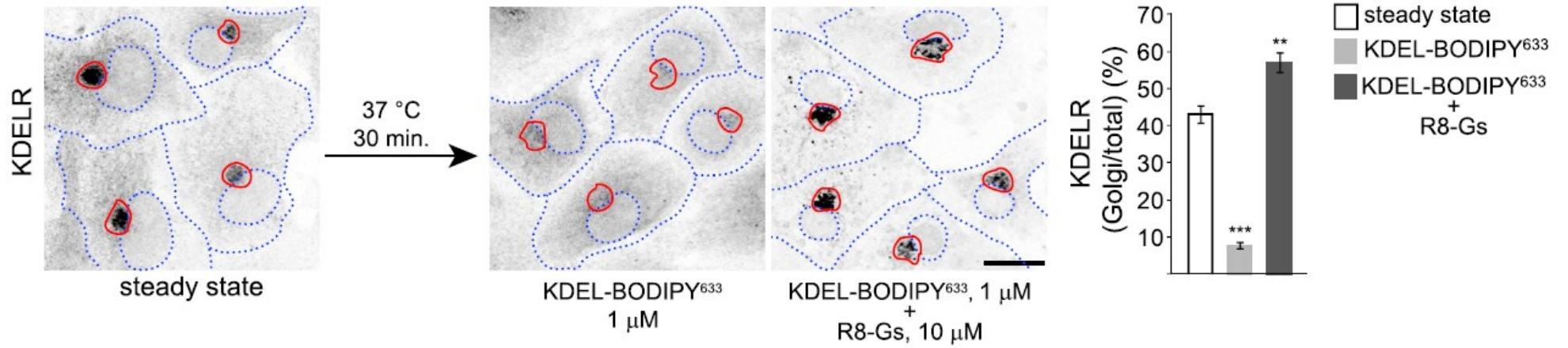

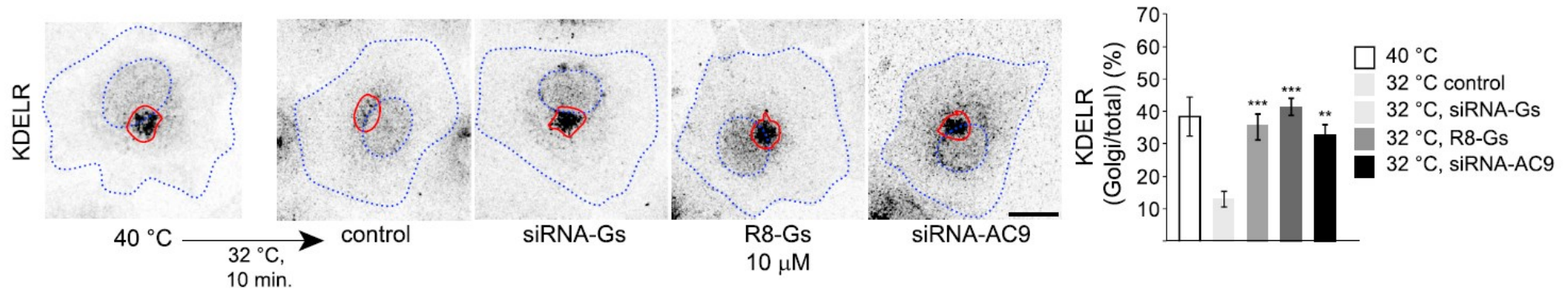

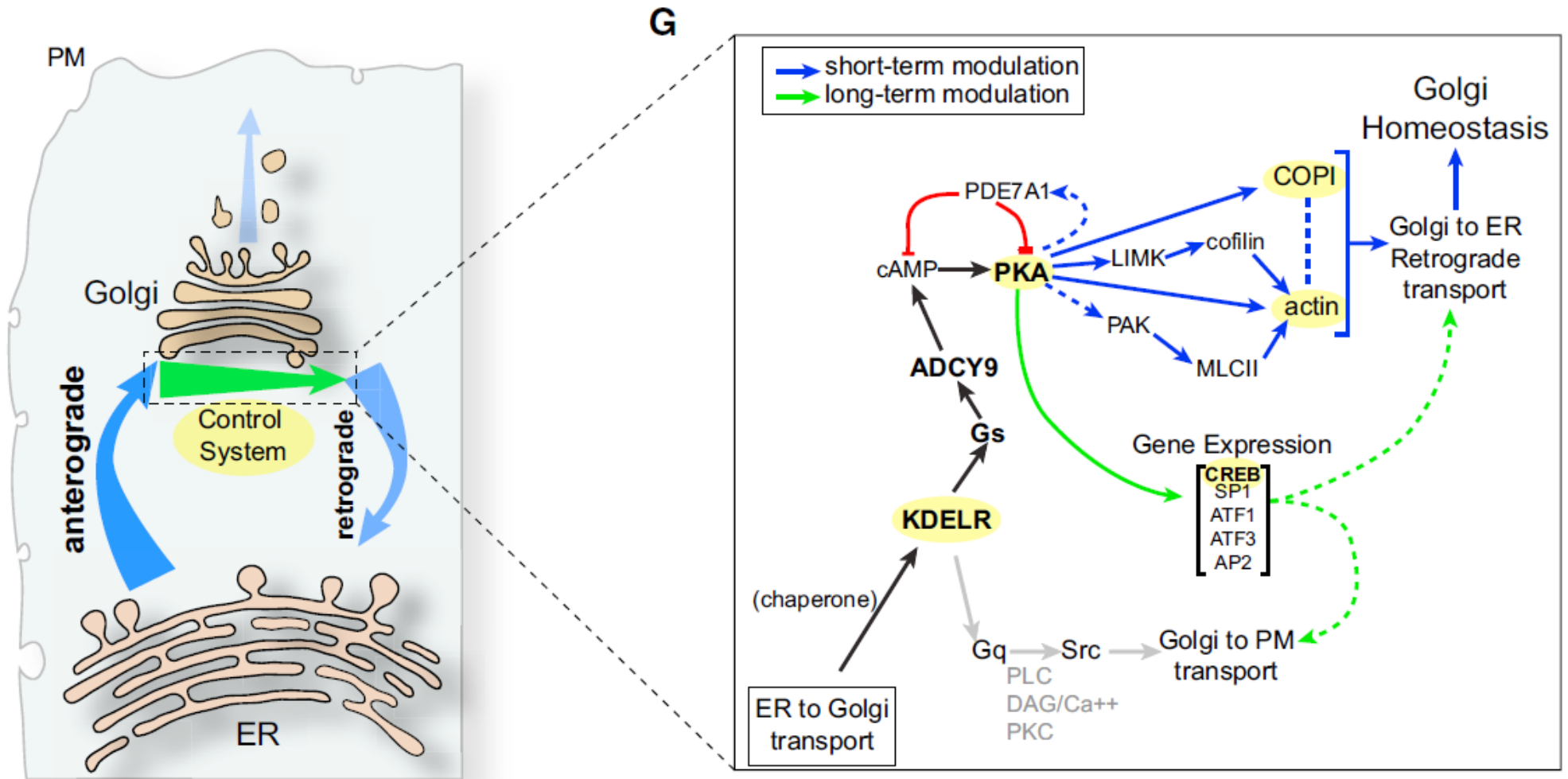



Grazie per l'attenzione