

# CROMATOGRAFIA E SPETTROMETRIA DI MASSA

Prof. Manuel Sergi

[msergi@unite.it](mailto:msergi@unite.it)

# TECNICHE CROMATOGRAFICHE

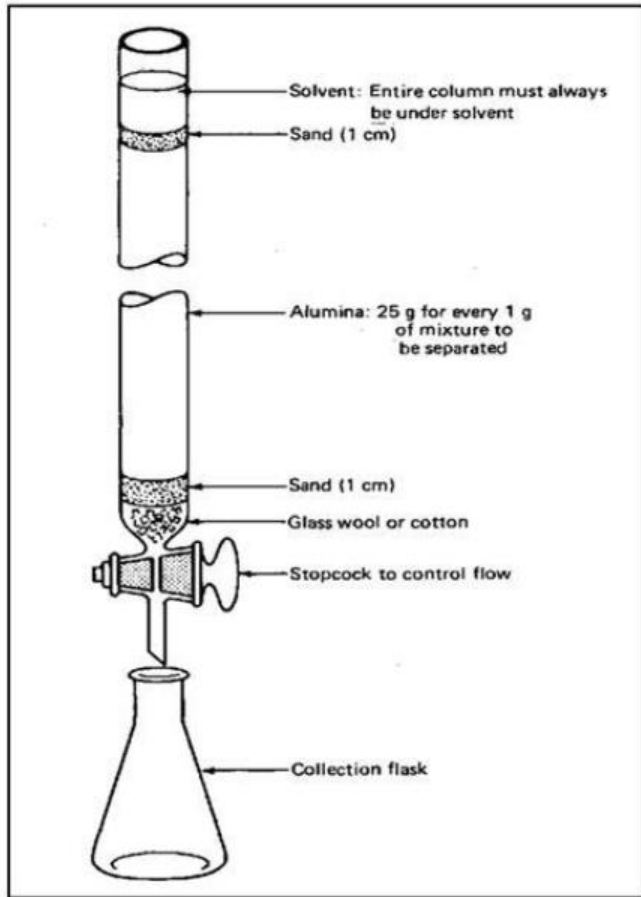

## SEMPLICI

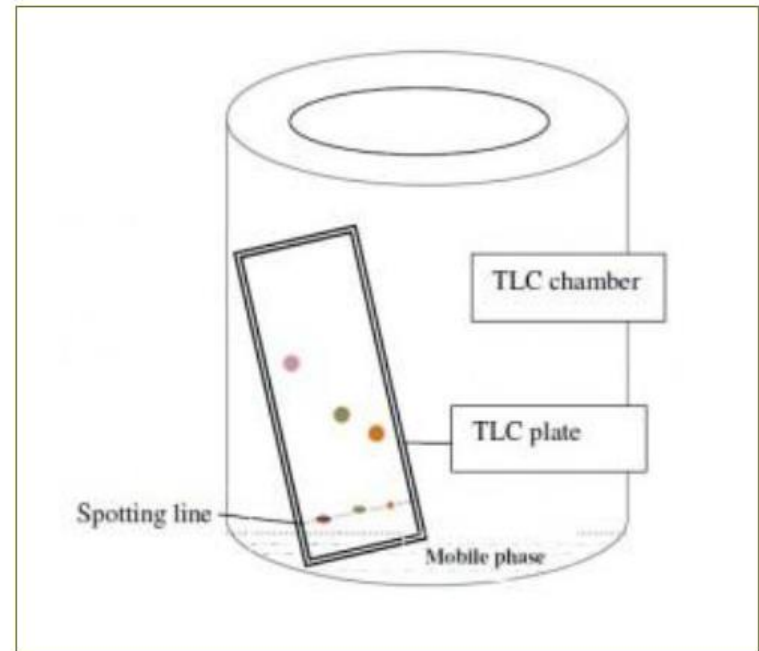

# TECNICHE CROMATOGRAFICHE

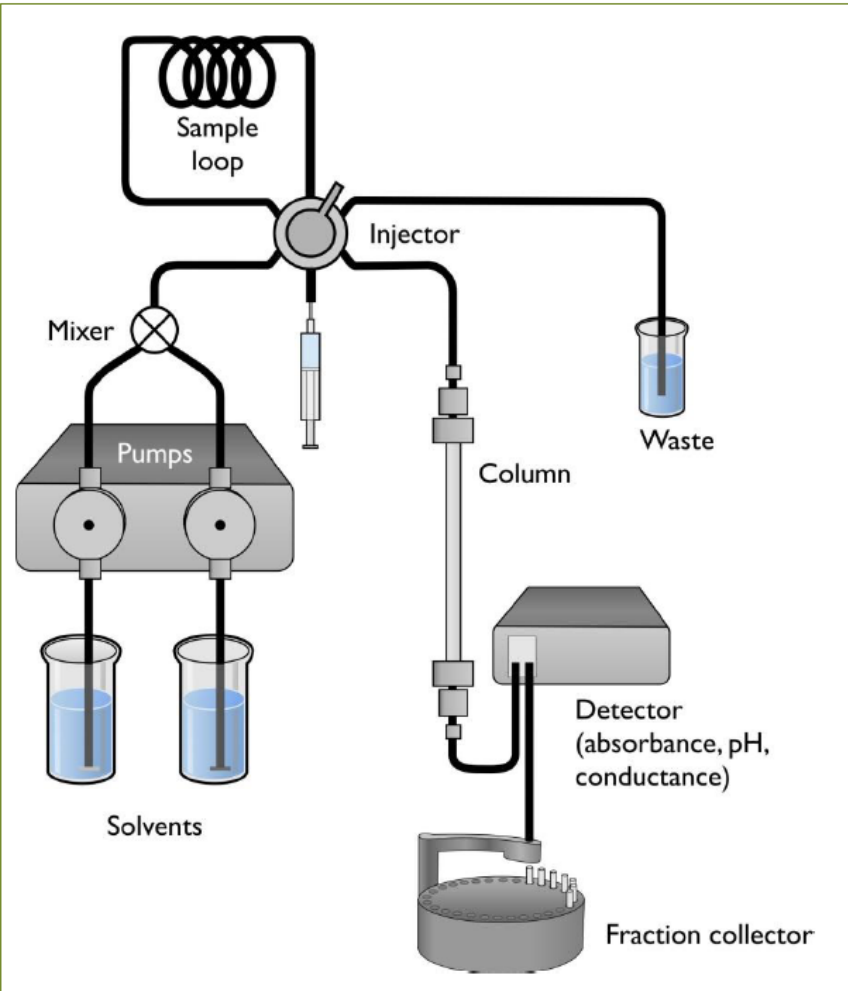

## AVANZATE

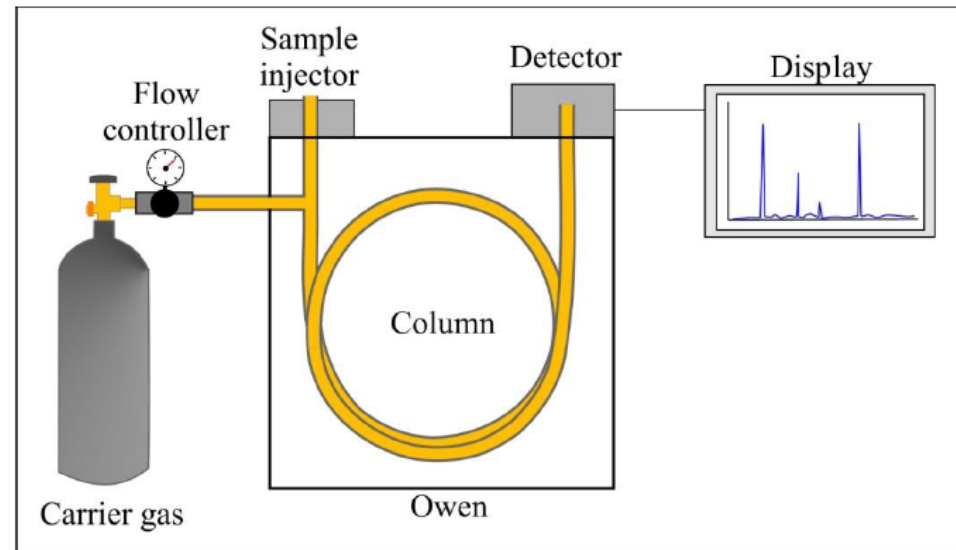
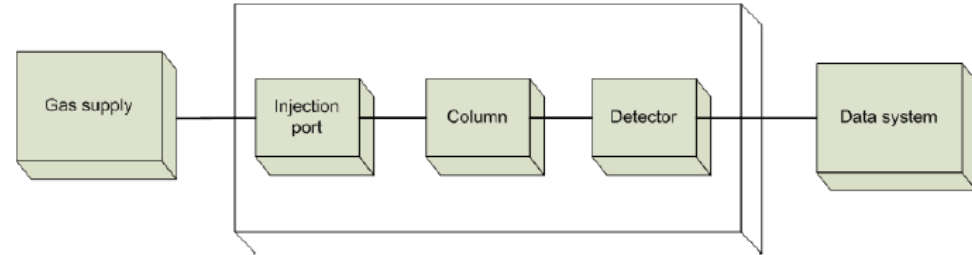

# CROMATOGRAFIA

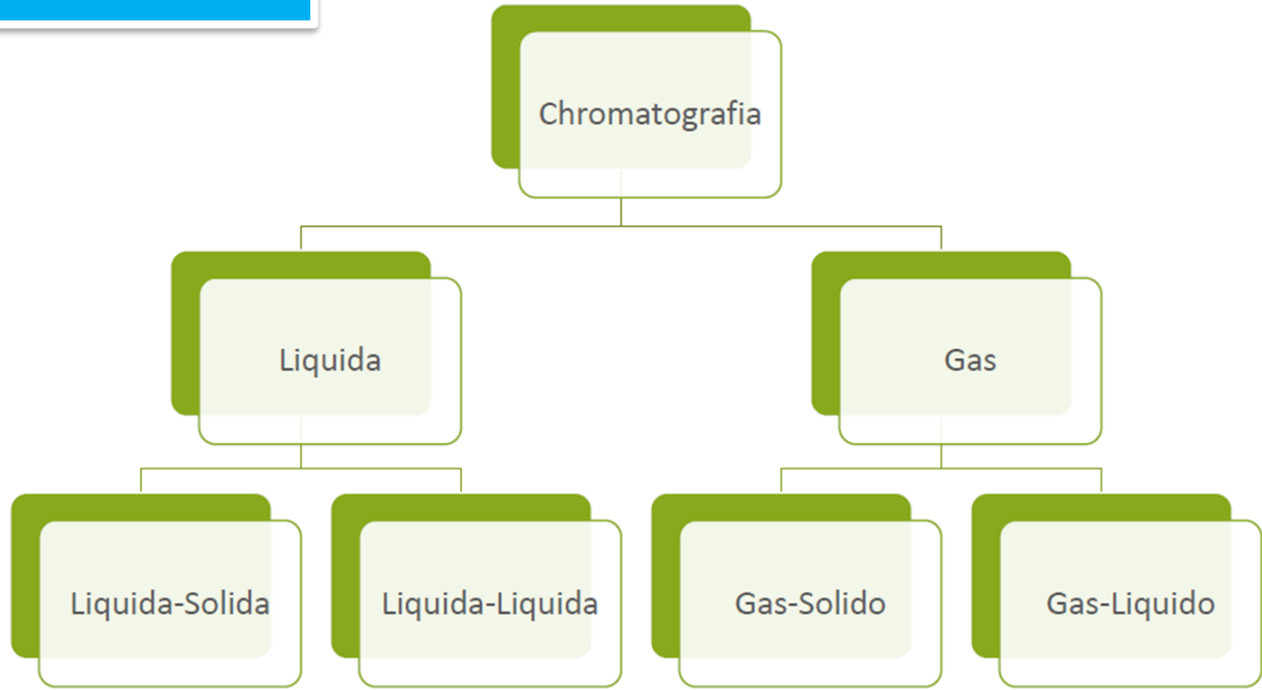

Il termine **cromatografia** indica un insieme di tecniche che hanno lo scopo di separare una miscela nei suoi componenti, per permetterne il riconoscimento qualitativo e quantitativo.

# Cromatografia GASSOSA (GC)



- Fase stazionaria: Film di fase inerte depositato in una colonna GC
- Fase mobile: un gas che fluisce attraverso la fase stazionaria e rappresenta la fase mobile (carrier gas).

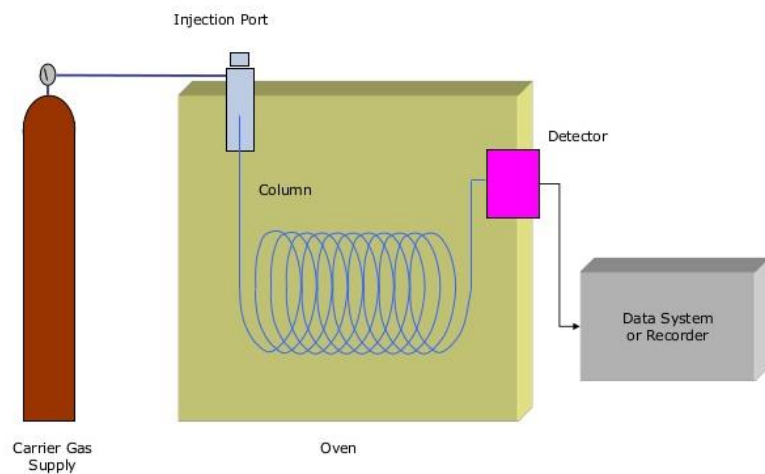

# Cromatografia LIQUIDA (LC)



- Fase stazionaria: silice o silice funzionalizzata
- Fase mobile: Solvente (o miscele di solventi)

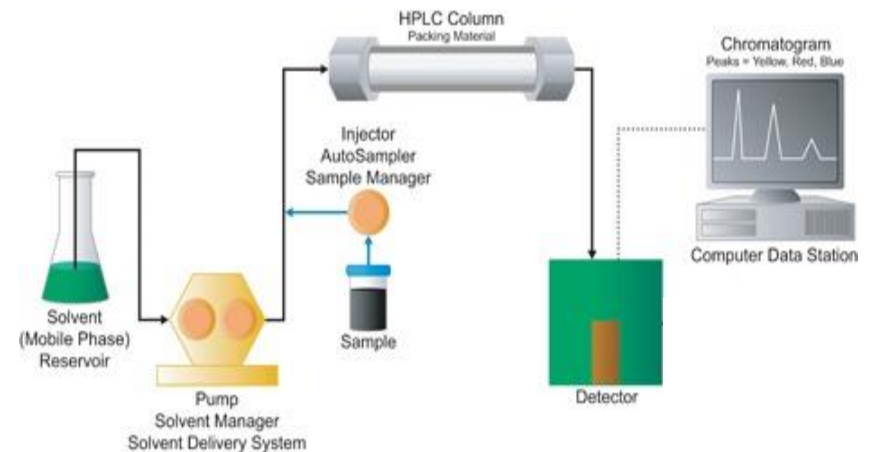

GC

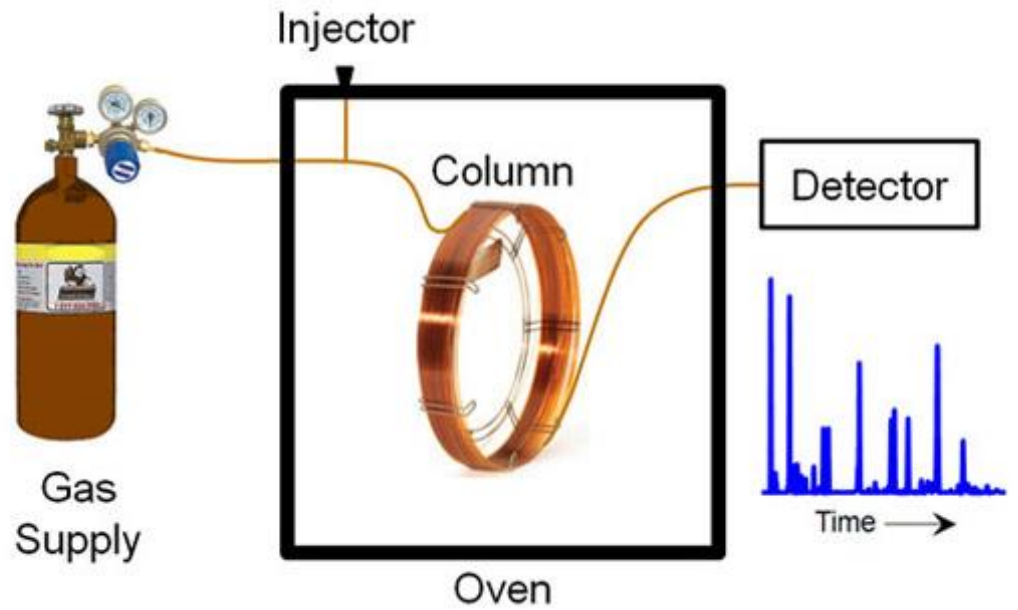

HPLC



## COLONNE CAPILLARI PER GC

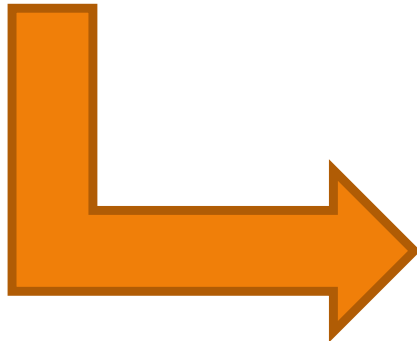

### GC COLUMN

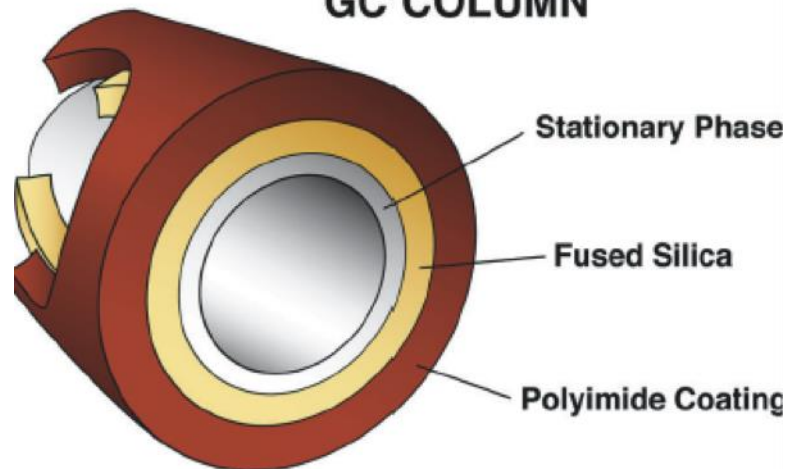

# COLONNE IMPACCATE PER HPLC

## Standart column hardware

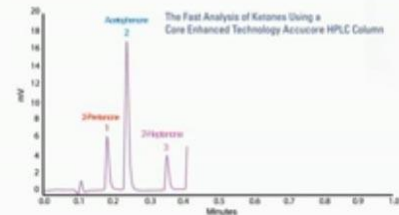
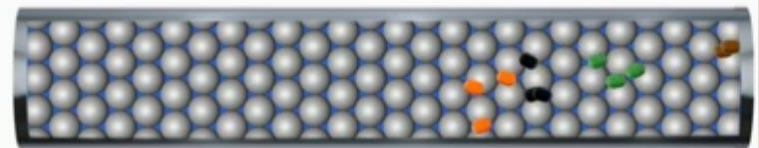
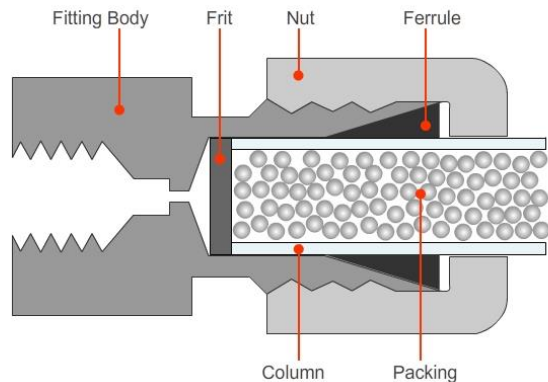
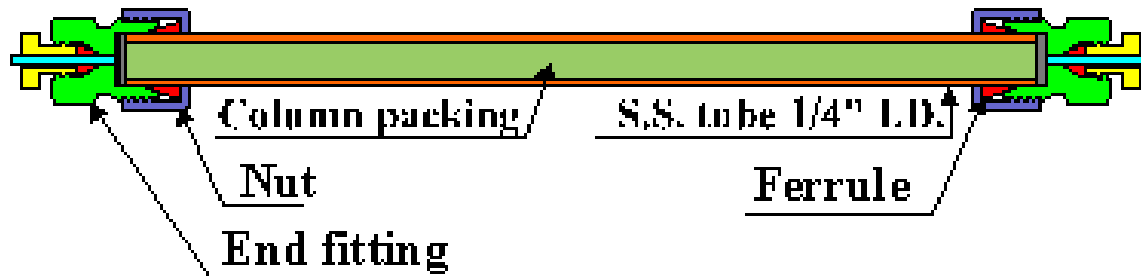

Retention Time	Compound
0.18 mins	2-Pentanone
0.24 mins	Acetophenone
0.35 mins	2-Heptanone
0.39.19 mins	Butyrophenone
0.39.19 mins	Hexanophenone
0.39.19 mins	Octanophenone
0.39.19 mins	Decanophenone



# Schema di un GC

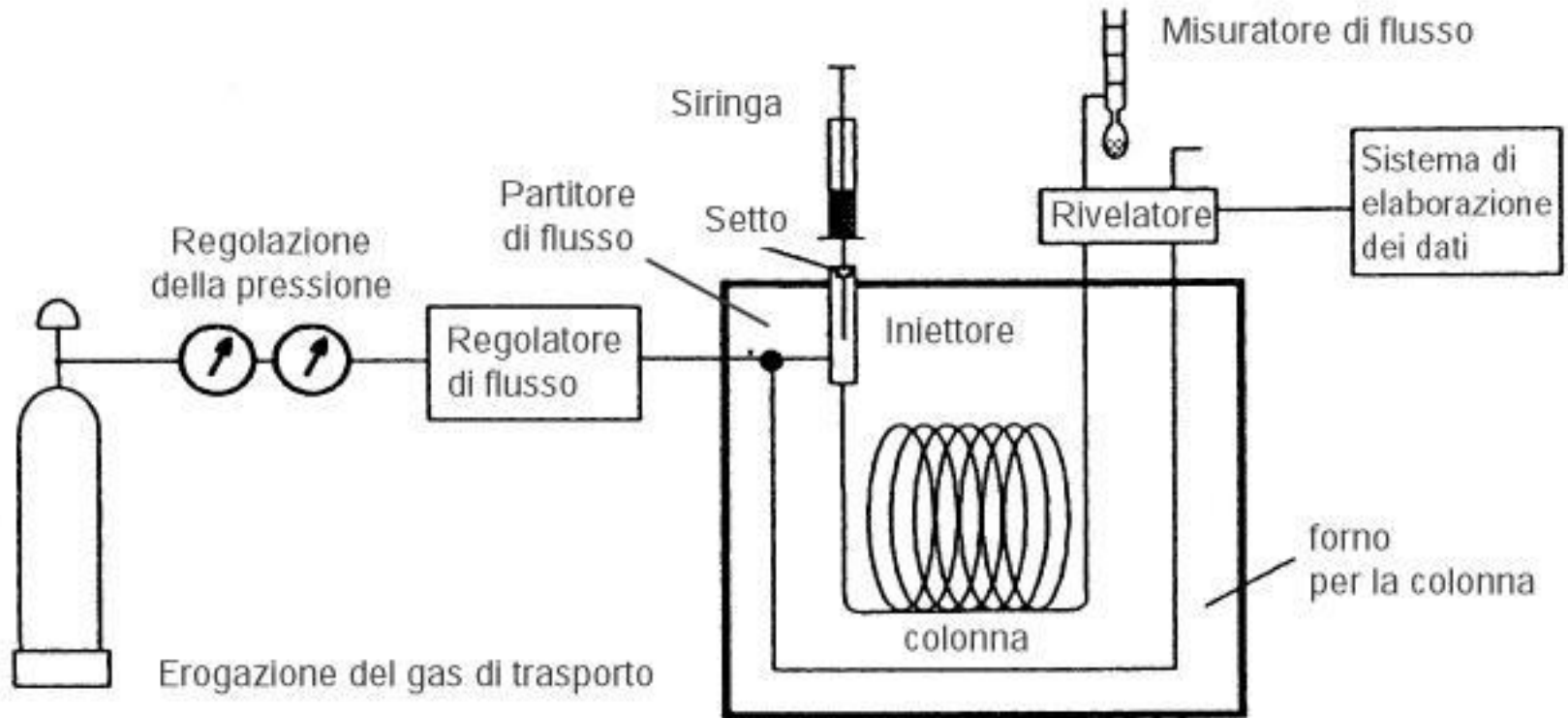

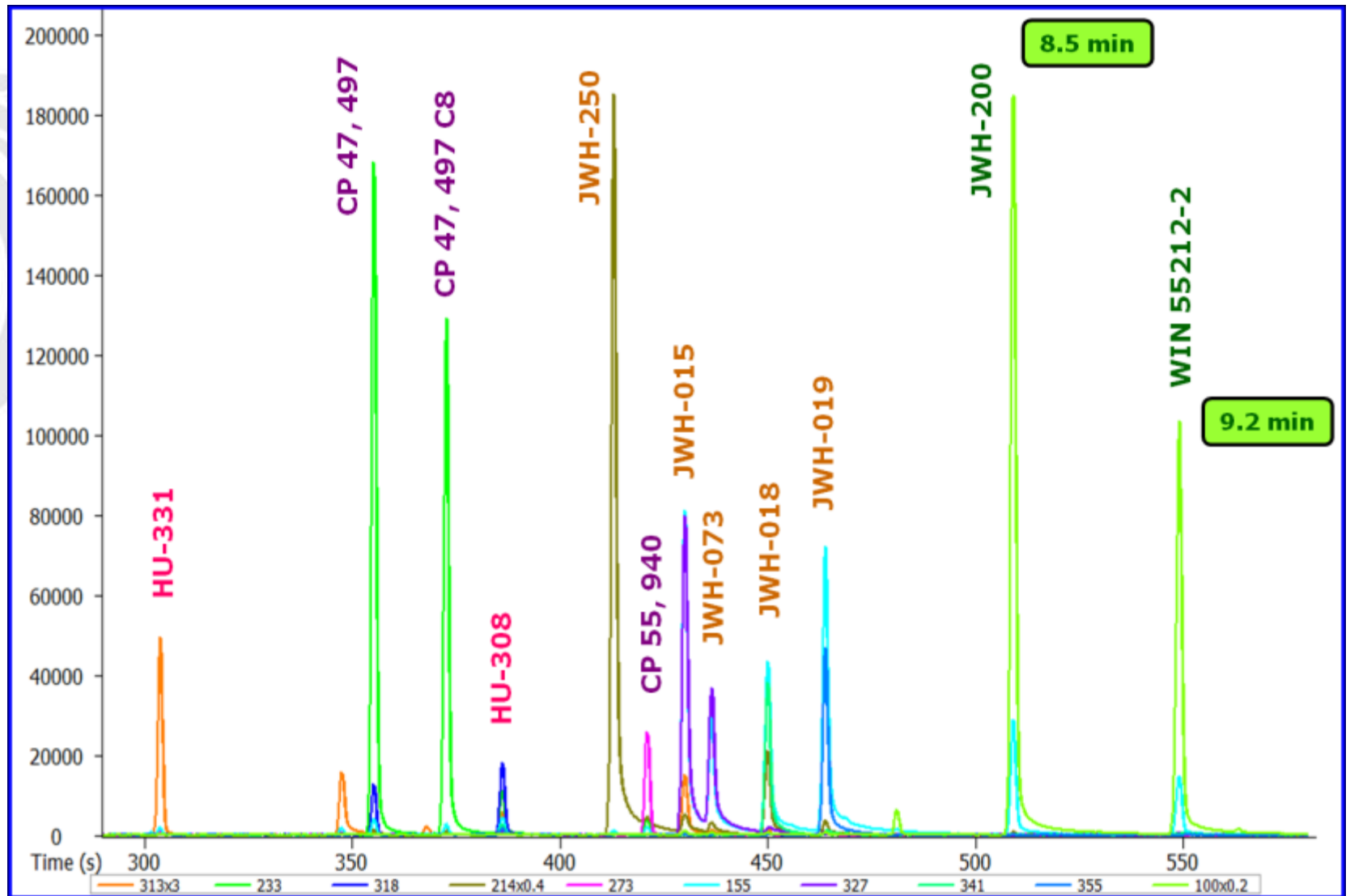

# Schema di un GC-MS

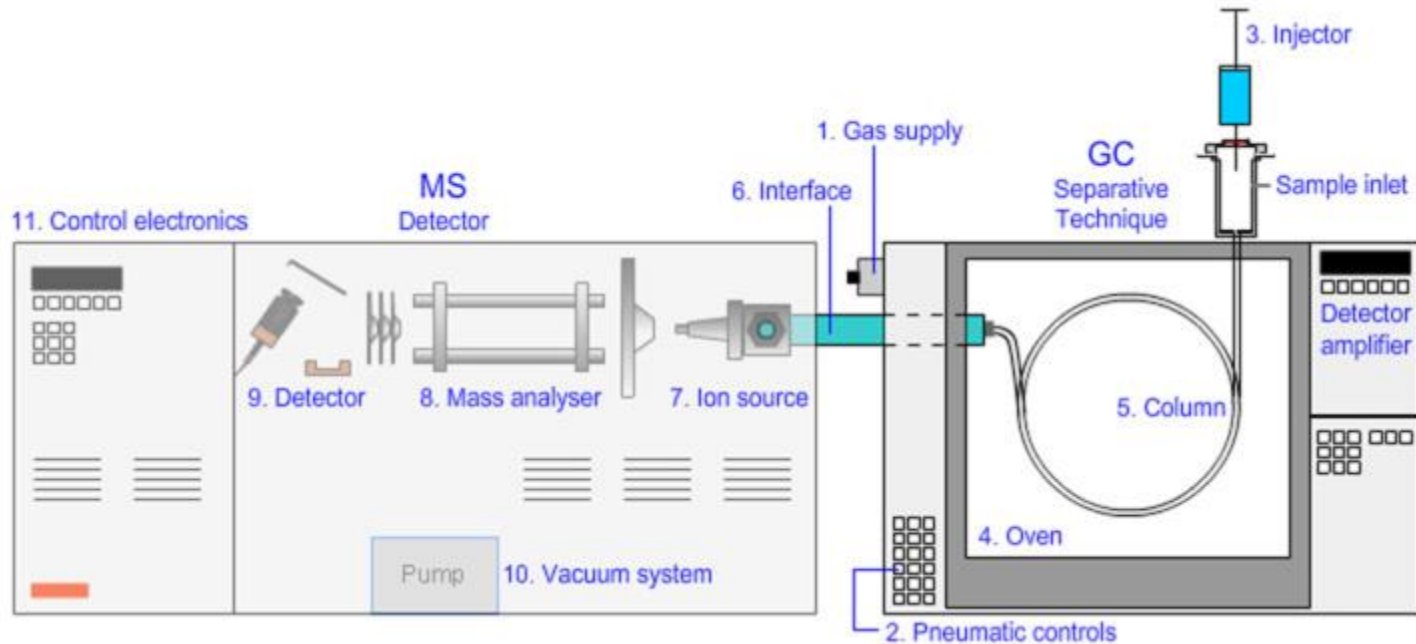

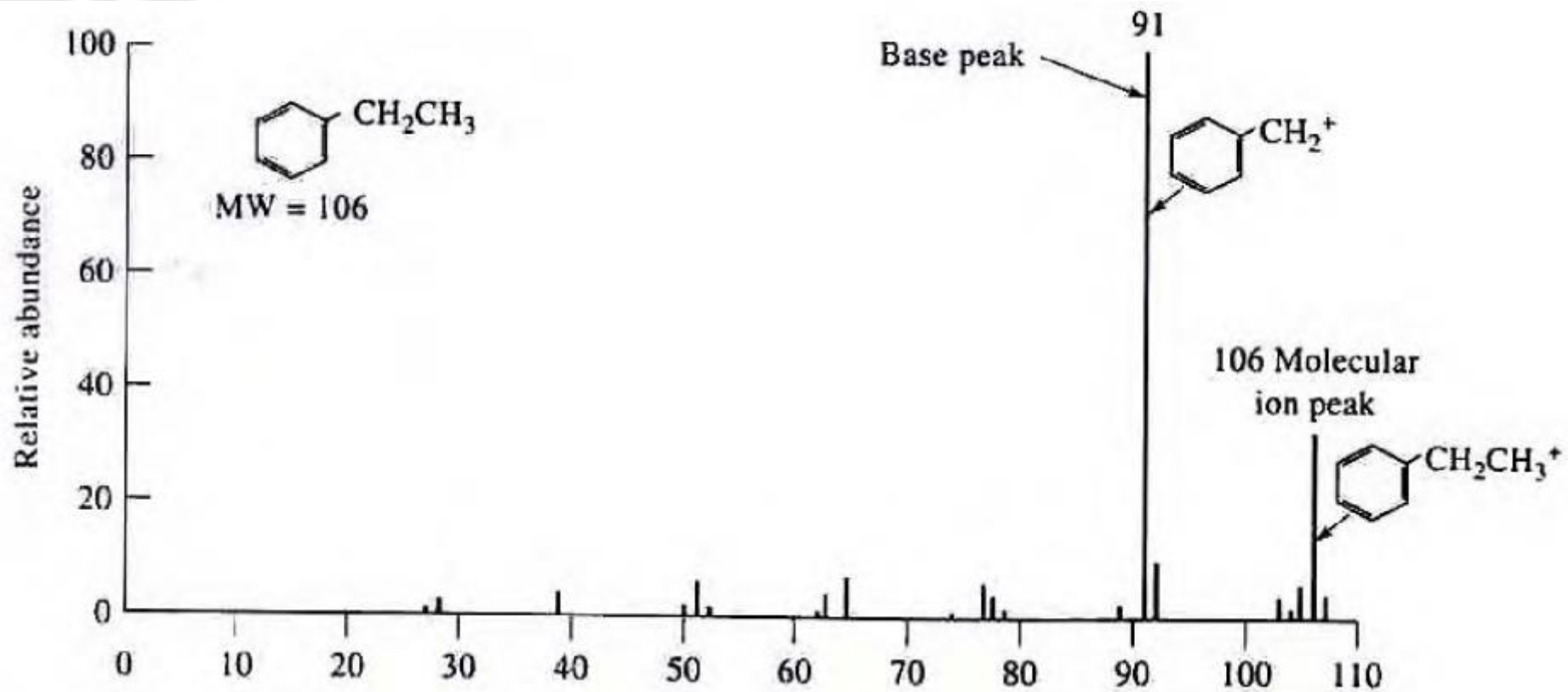

# Cromatografia Liquida

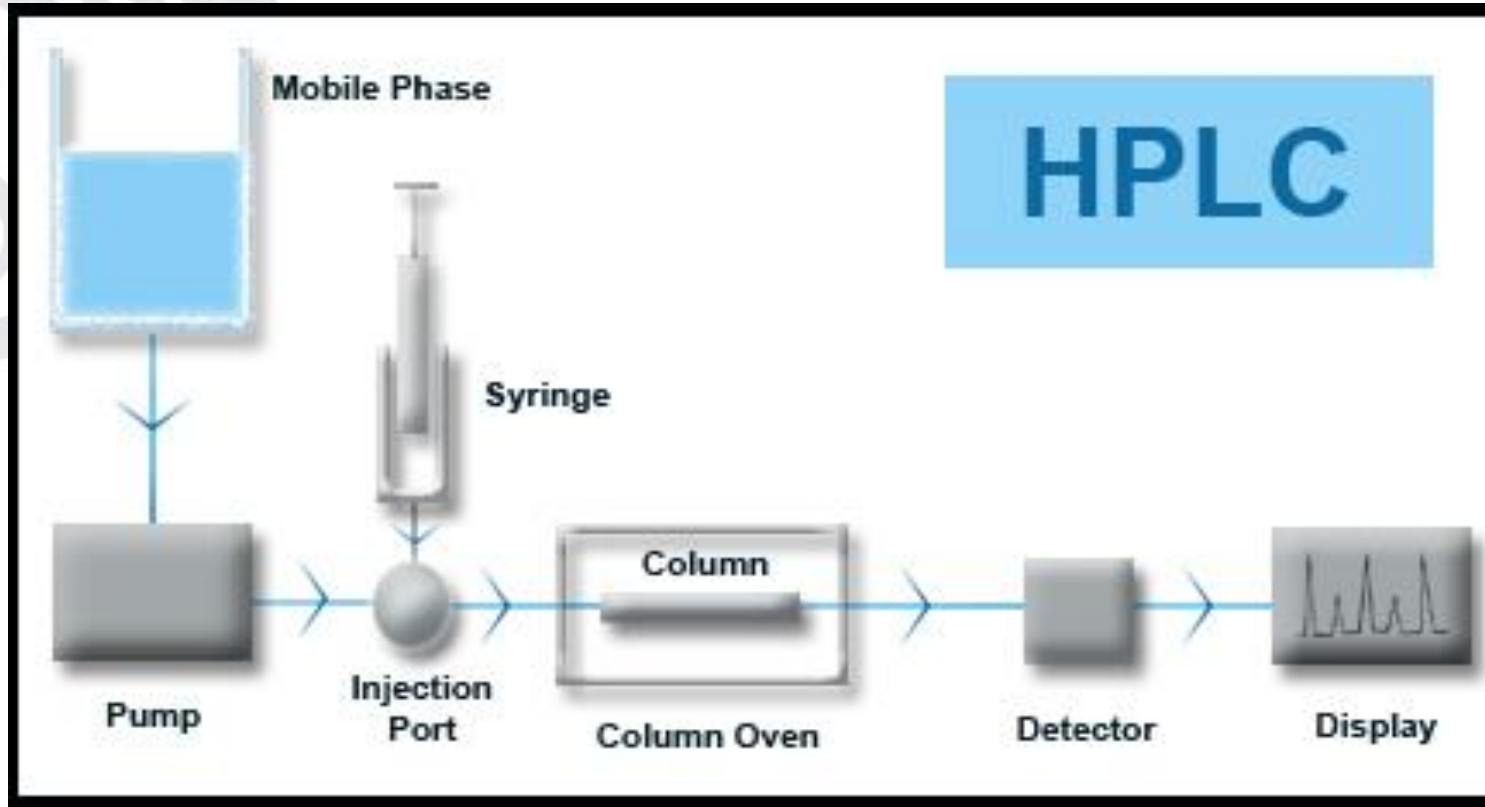

# INIEZIONE DEL CAMPIONE

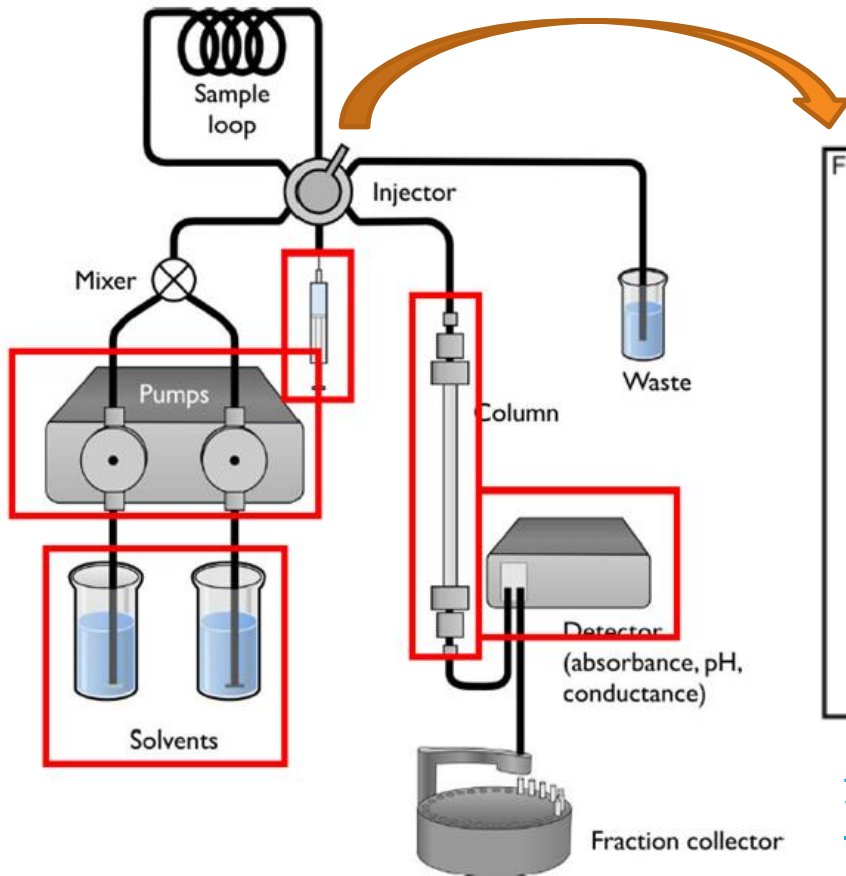

Valvola a 6 vie: 2 posizioni

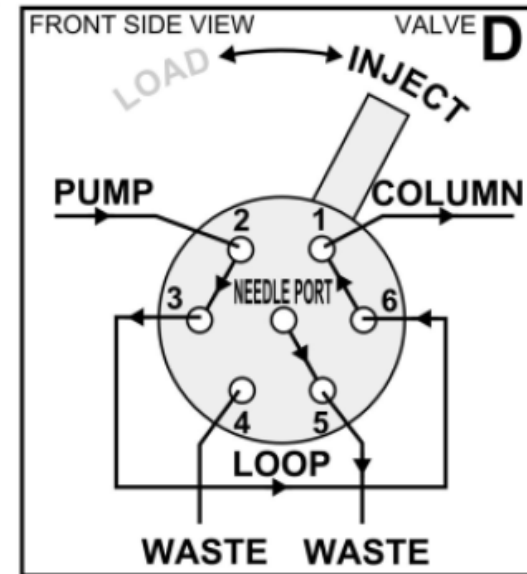
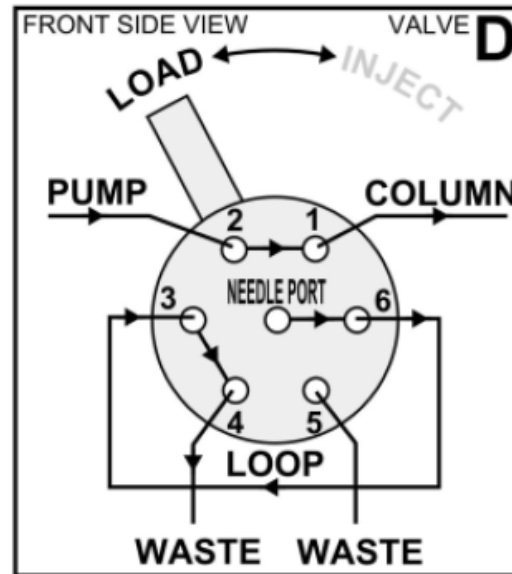

[www.CHROMacademy.com](https://www.CHROMacademy.com) - YouTube

# Adsorption Chromatography

Competition between solvent and solutes for the active sites on the stationary phase

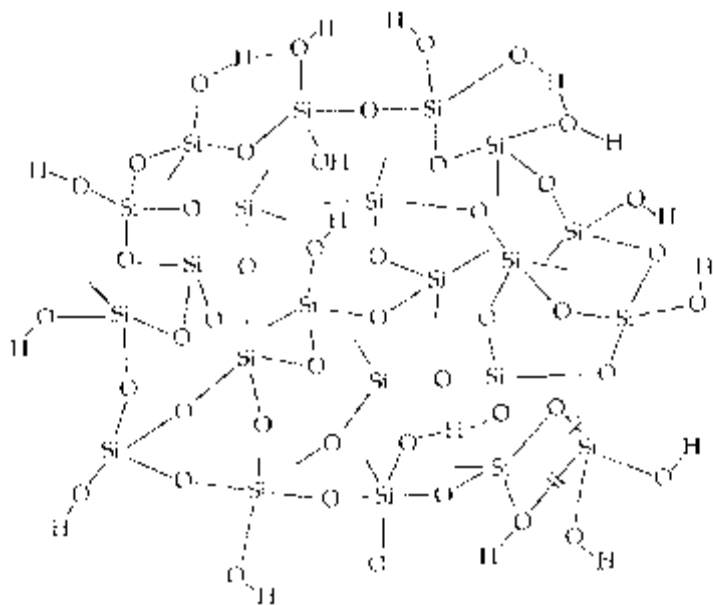

# Partition Chromatography

The silanolic groups are derivatized modifying the surface properties for specific applications

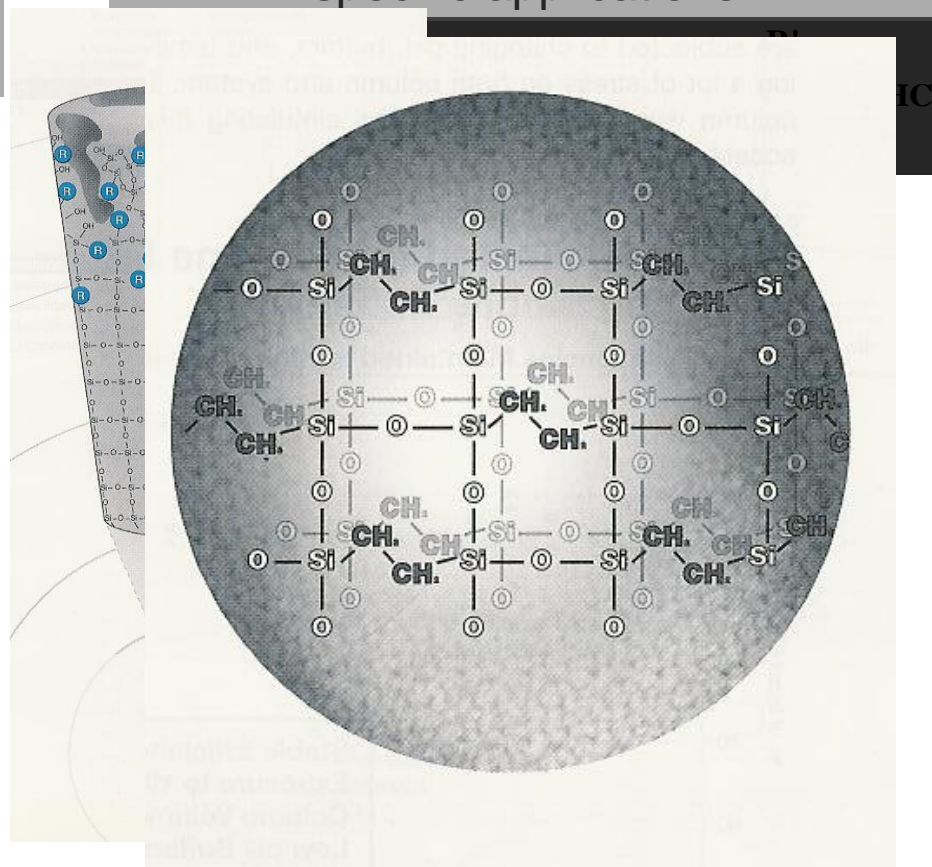

# REVERSED PHASE CHROMATOGRAPHY

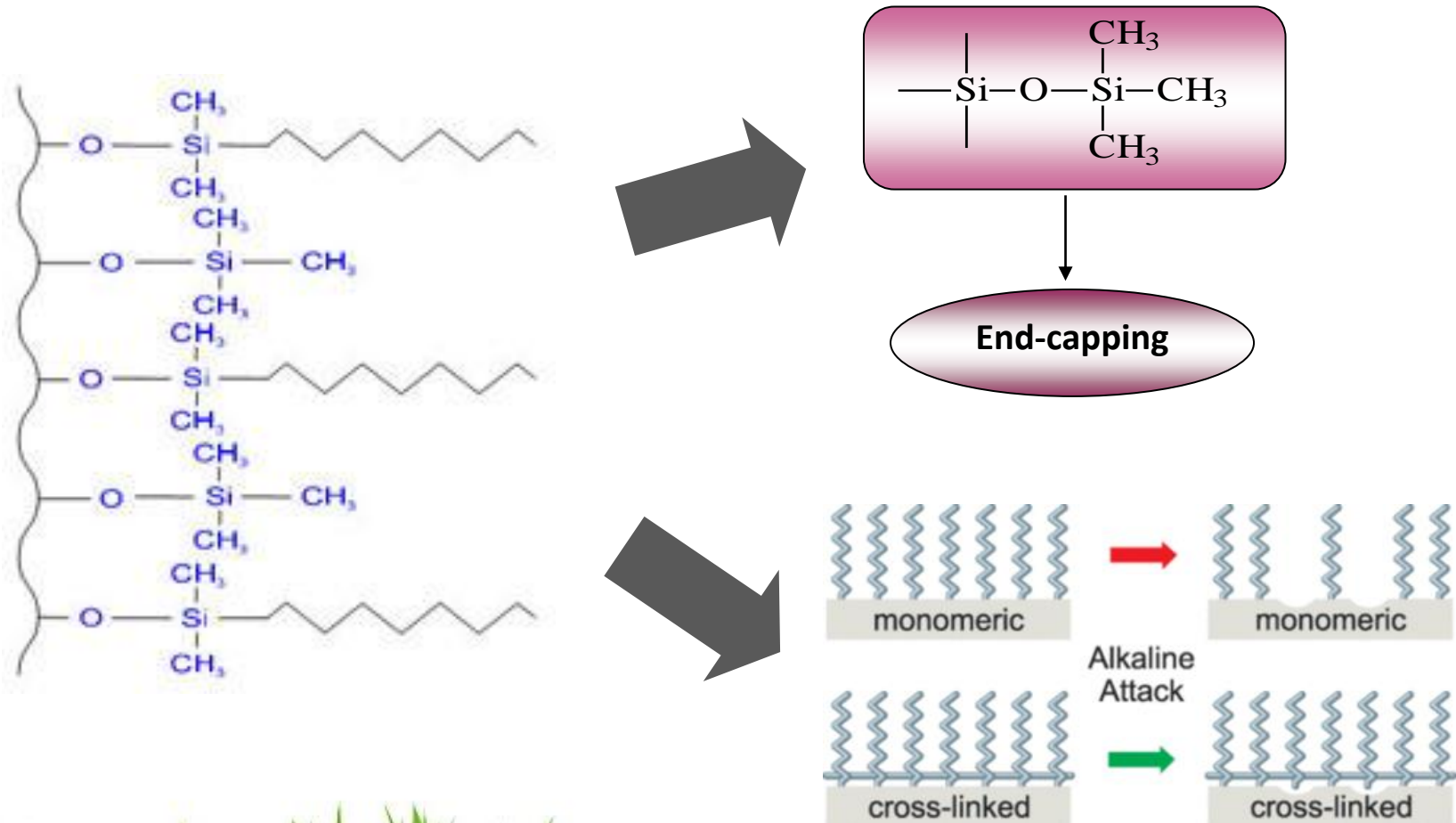



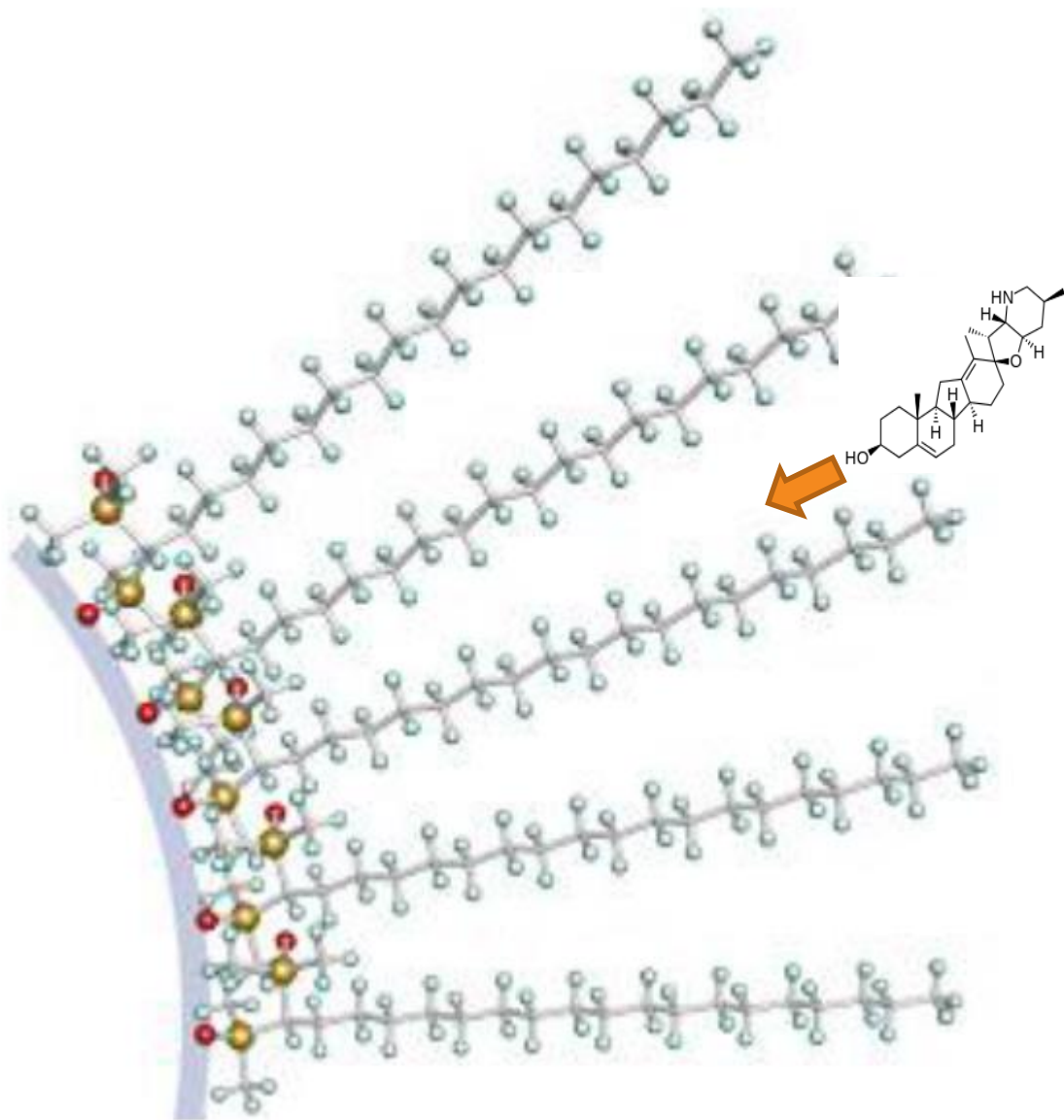

## H: altezza Equivalente di un Piatto Teorico (HEPT)

$$H = L/N = L/16 (W / t_{Ri})$$

### Equazione di van Deemter: $H = A + B/u + Cu$

A= diffusione vorticosa (è inutile per GC).

B= diffusione longitudinale

C= trasferimento di massa (cinetica di adsorbimento/desorbimento)

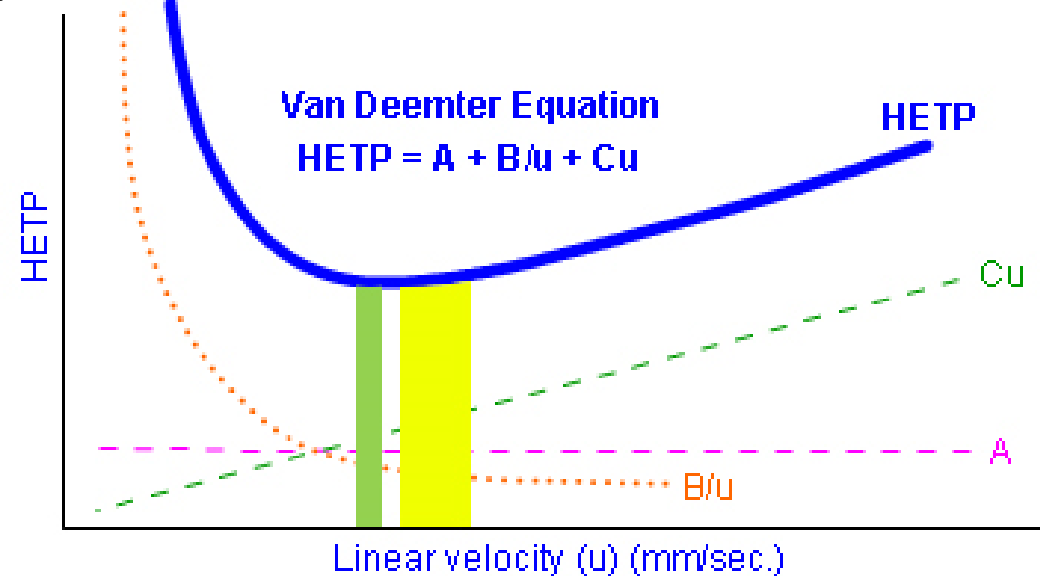

 Theoretical Optimum

 Practical Optimum

# HIGH EFFICIENCY HPLC

New particles feature a high-capacity, porous silica layer fused to a solid silica core

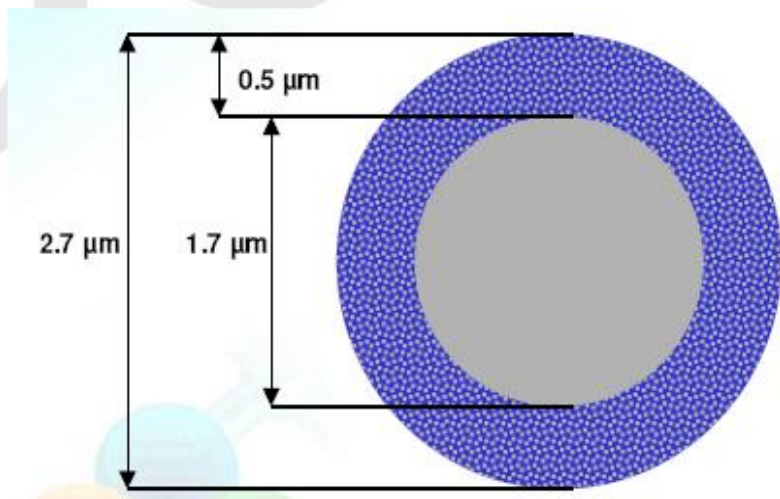

**Shorter diffusion path for Fused-Core improves peak resolution, resulting in efficiency similar to that of a 3 μm particle.**

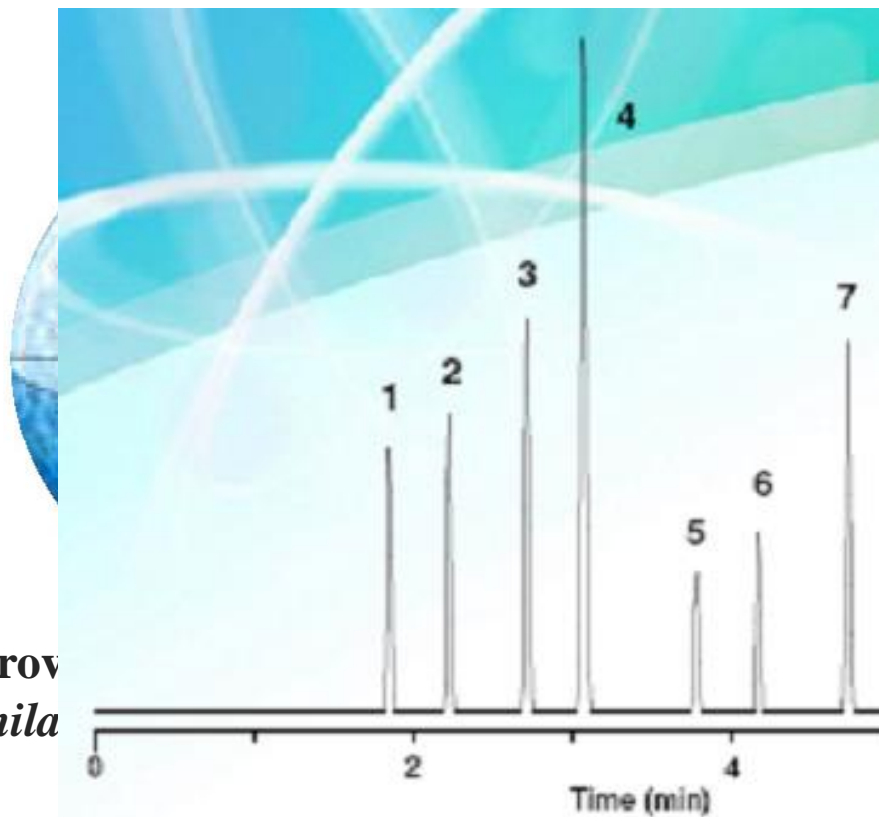

# UHPLC

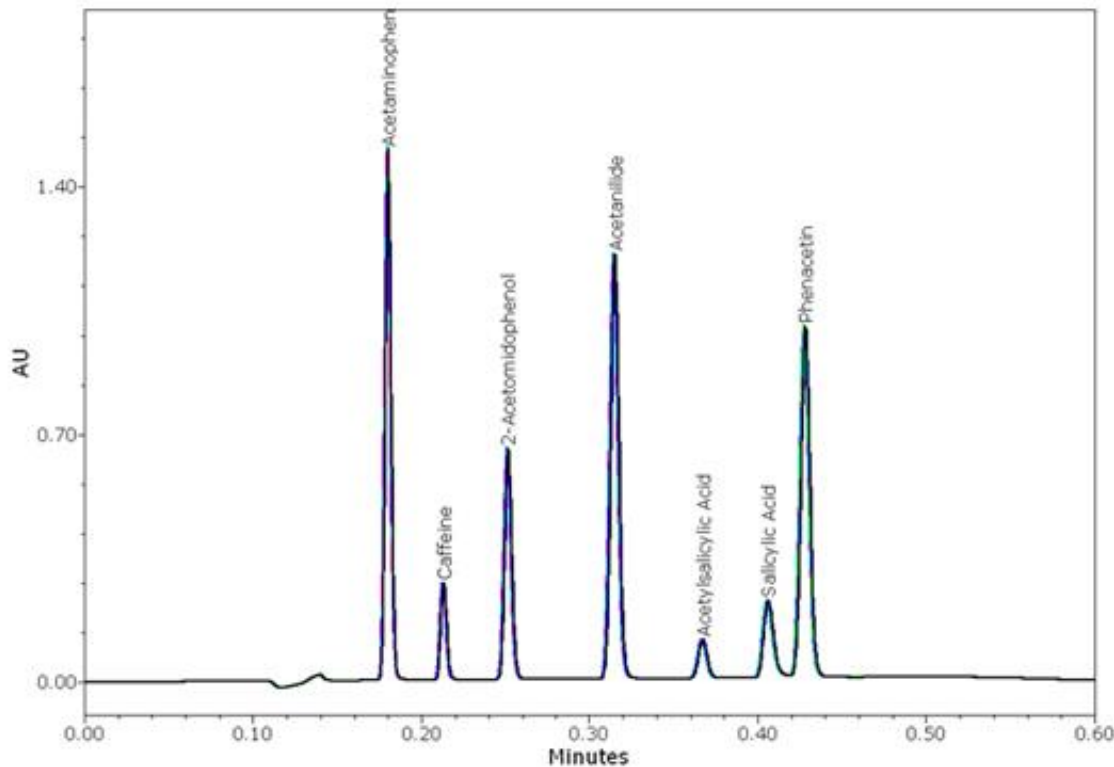

Colonne contenenti una fase stazionaria con diametro delle particelle molto minore oltre a pompe e parti meccaniche in grado di operare a pressioni di esercizio ancora più elevate.

La tecnica UHPLC permette di ottenere una separazione delle sostanze eluite caratterizzata da una maggiore efficienza e in tempi notevolmente ridotti, utilizzando come fase stazionaria particelle dal diametro solitamente inferiore a 2  $\mu\text{m}$  e pressioni che possono superare i 1000 bar.

# UHPLC: PARTICLE SIZE

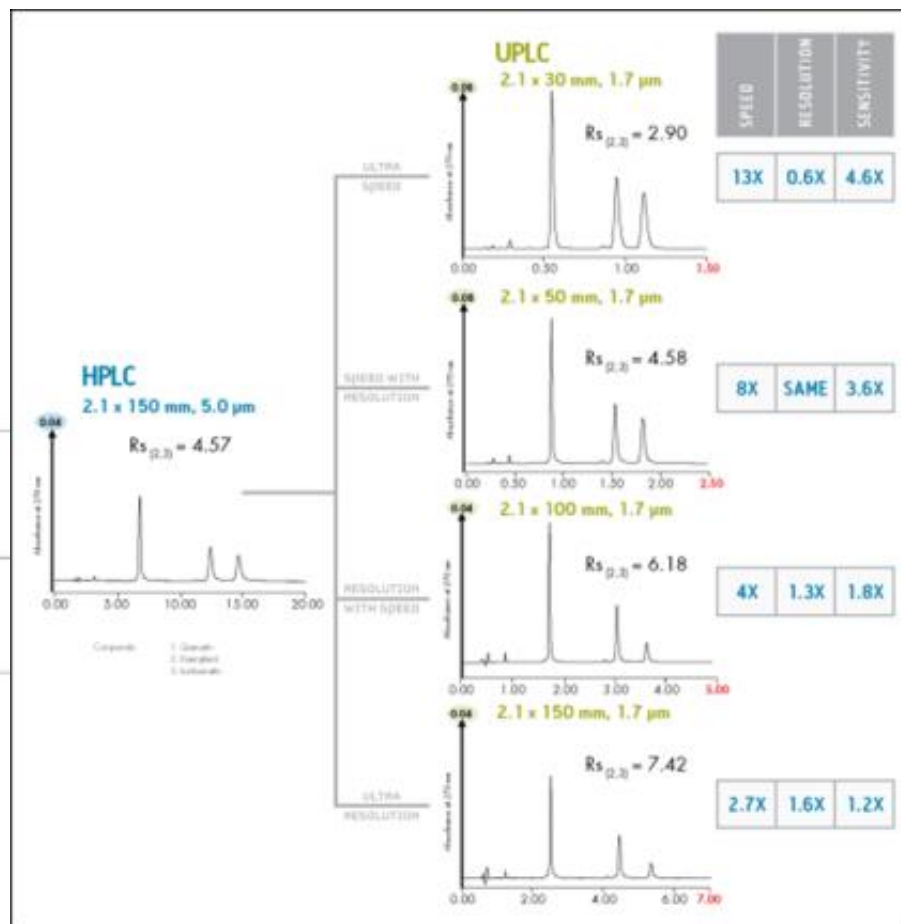

# Particle diameter vs HETP

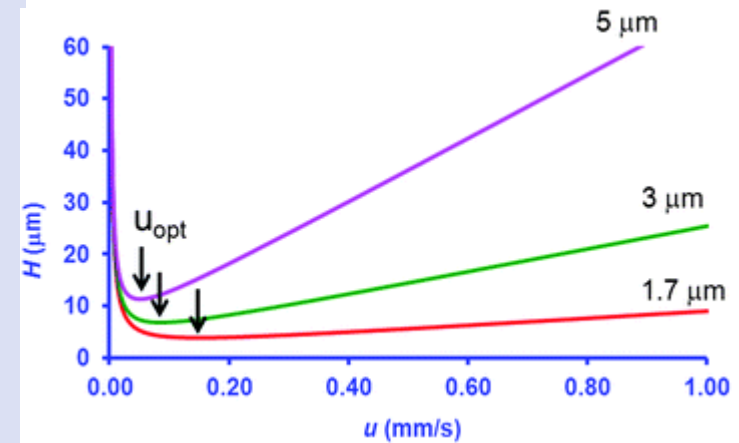
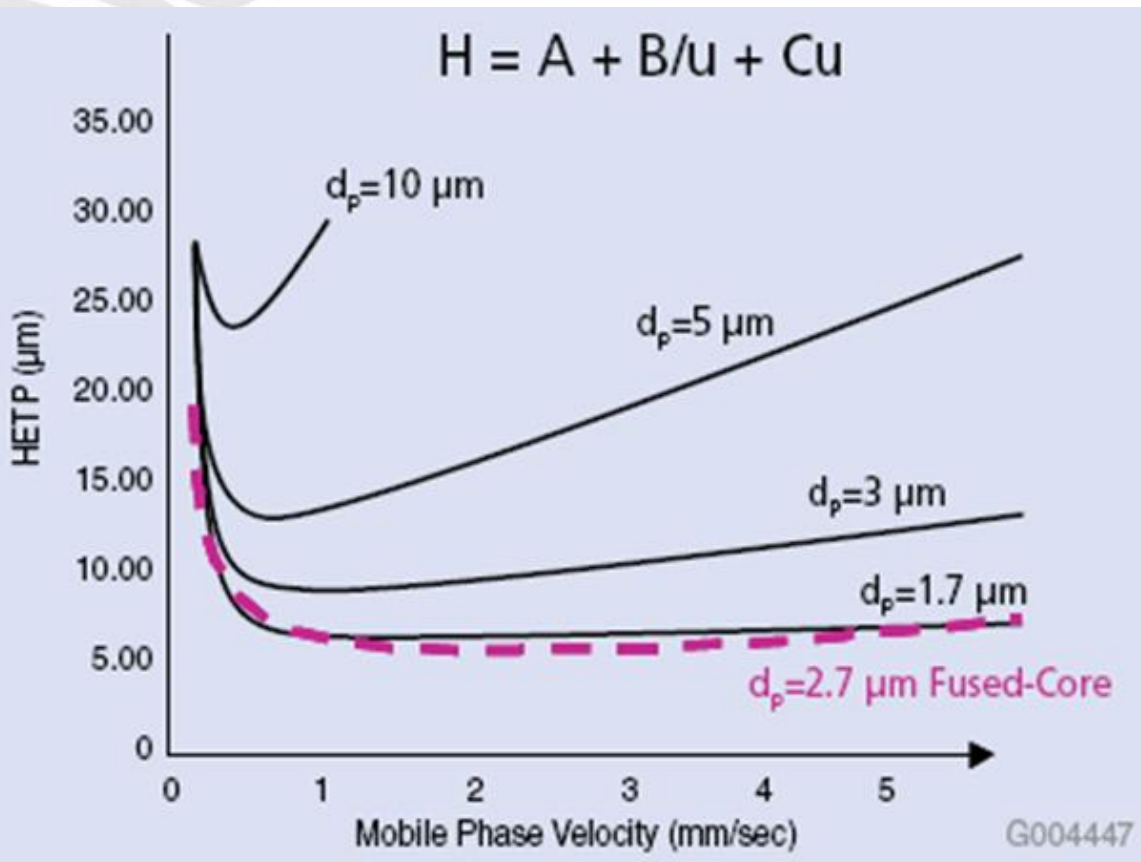

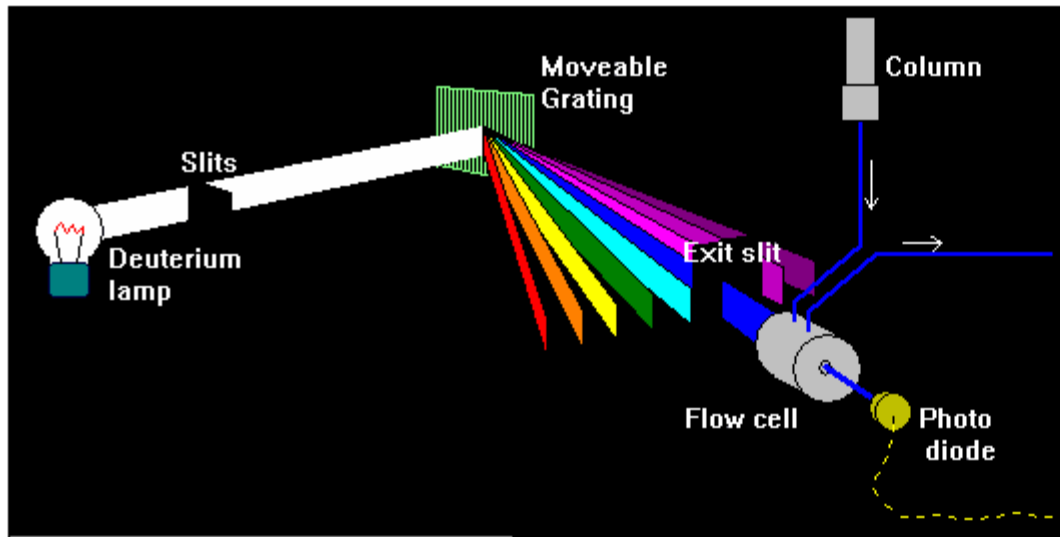

# UV DETECTOR

# DIODE ARRAY DETECTOR

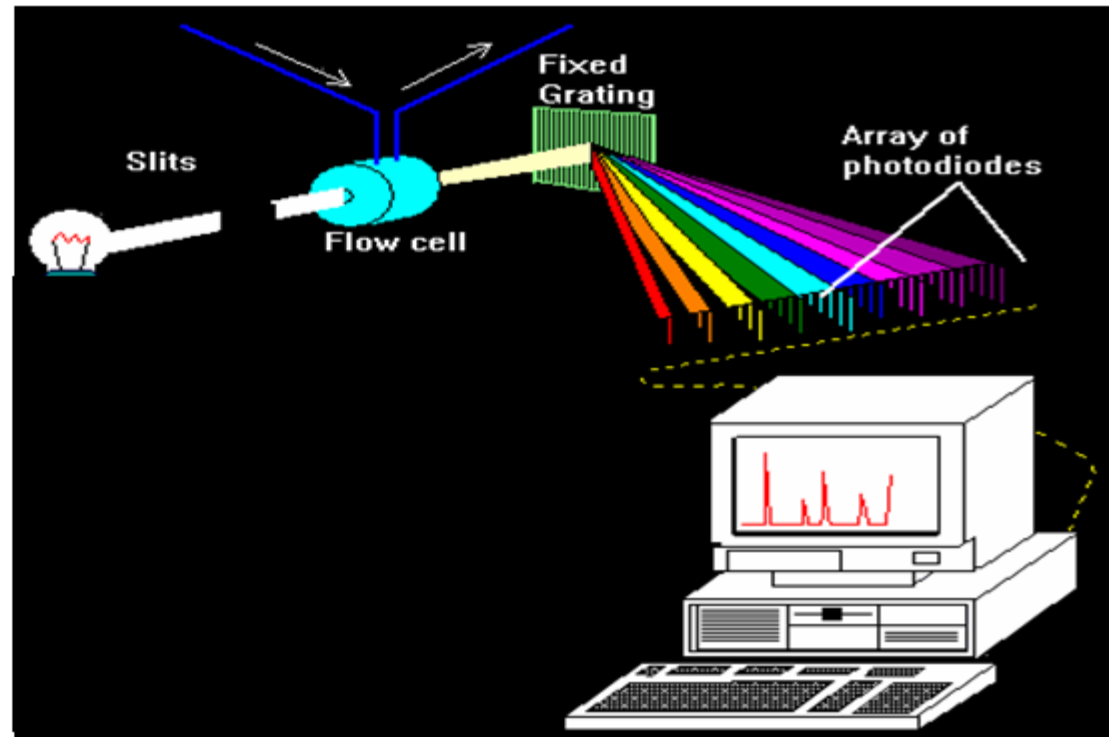

# CROMATOGRAMMA

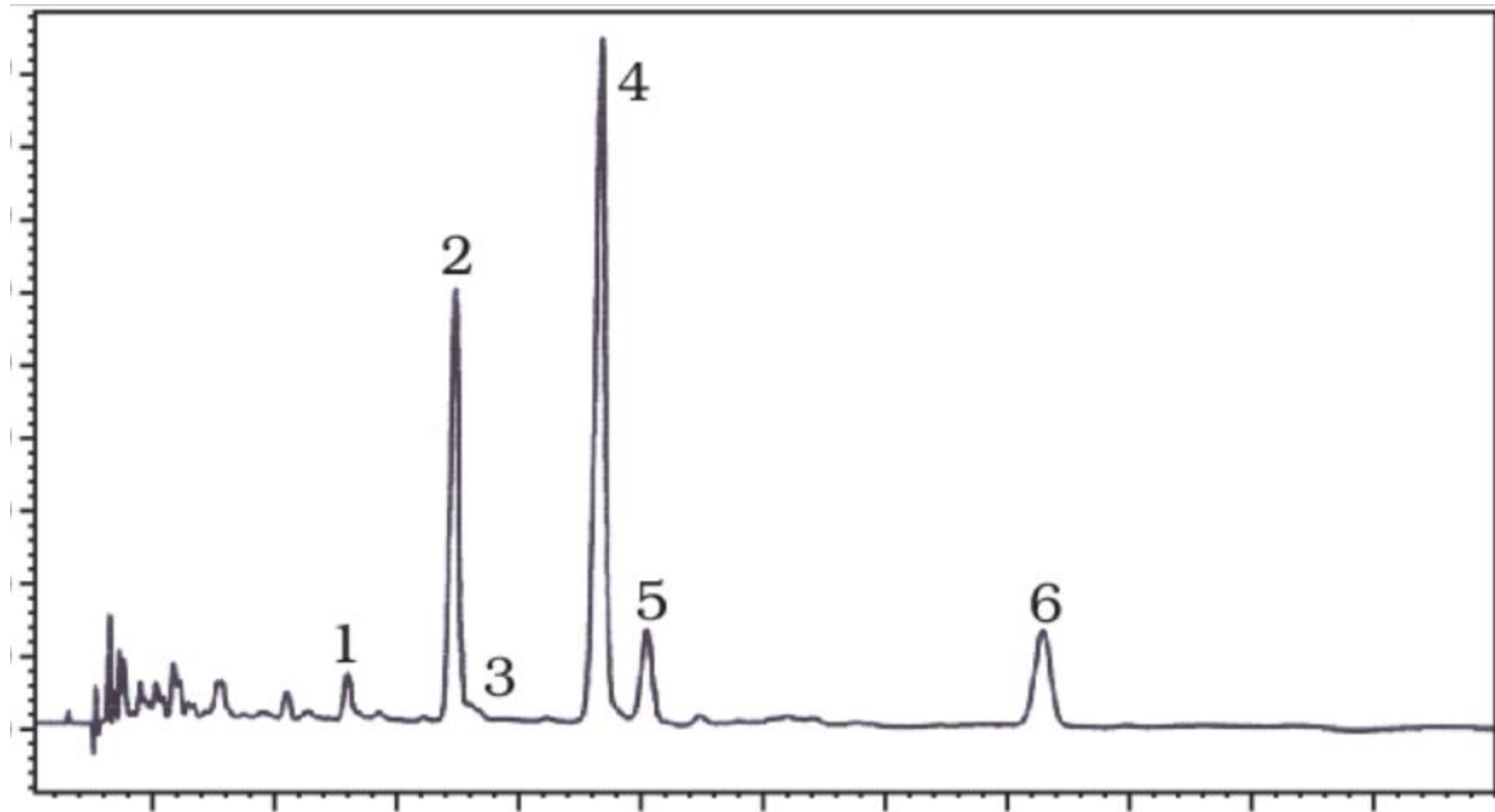



# CROMATOGRAMMA HPLC (o GC)-MS

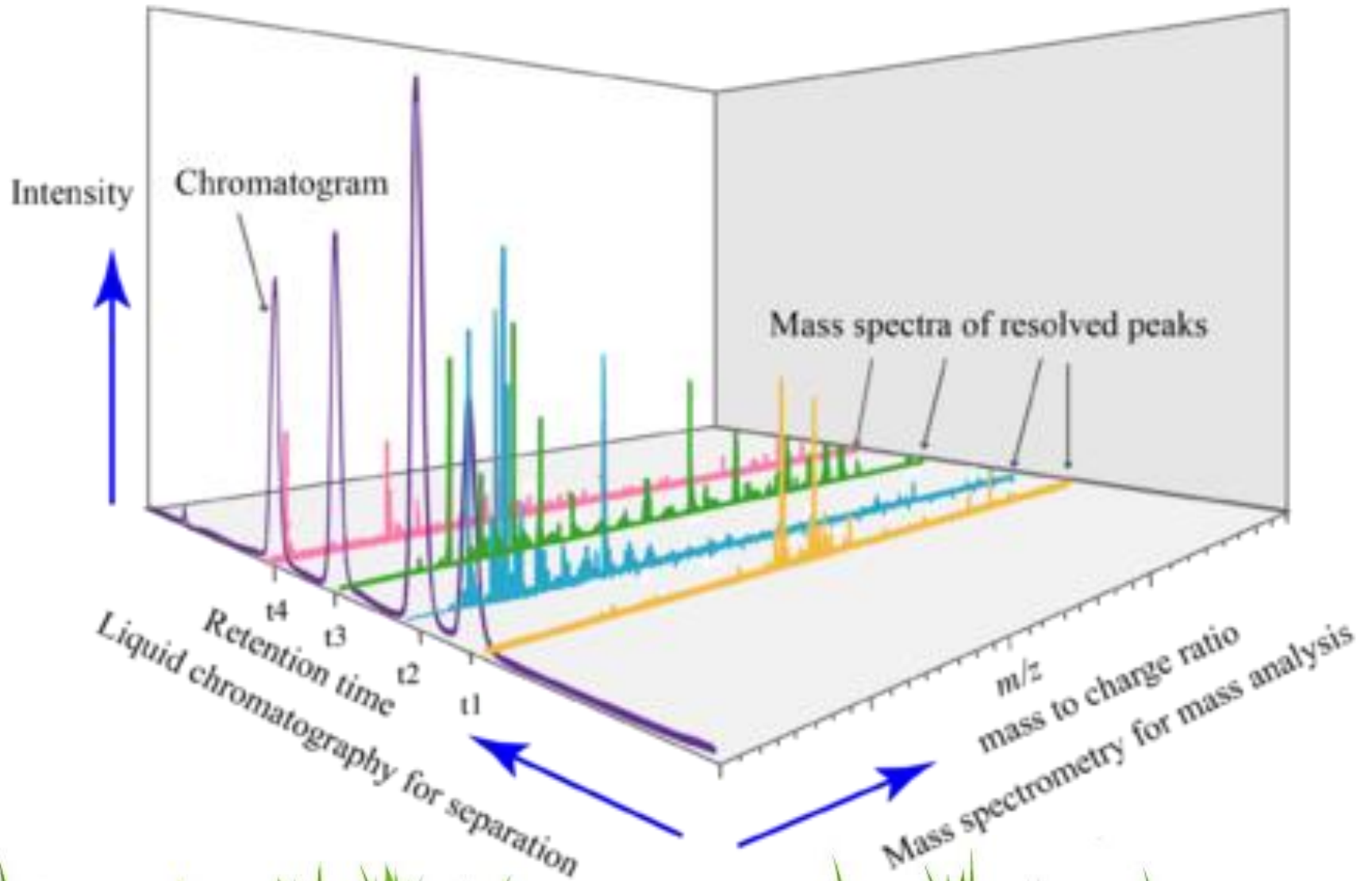

# Cromatografia e Spettrometria di Massa

La **spettrometria di massa** è una tecnica analitica basata sulla ionizzazione di atomi e/o molecole e la successiva rivelazione dei generati ioni gassosi in base al rapporto massa/carica ( $m/z$ ).

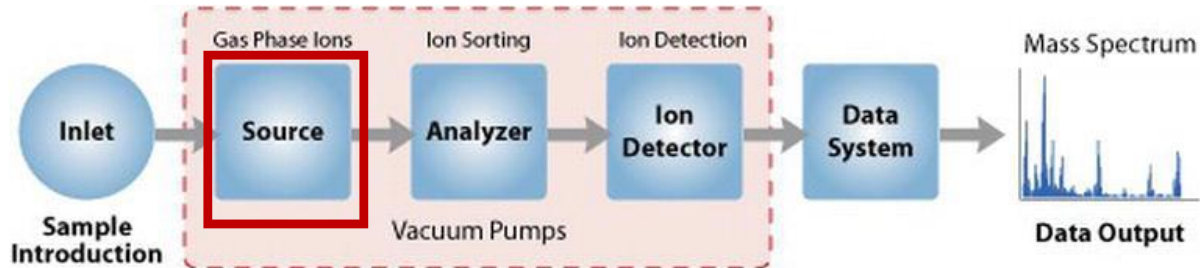
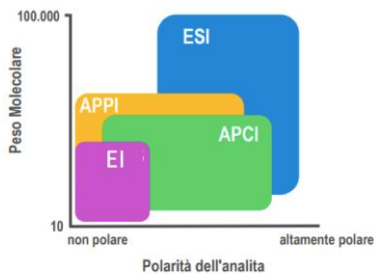

## 1. Gas Phase:

- Electron ionization (EI)
- Chemical ionization (CI)
- Field Ionization (FI)

## 2. Desorption: (Non richiedono volatilizzazione: fase condensata)

- Field Desorption (FD)
- Fast Atom Bombardment (FAB)
- Secondary Ion Mass Spectrometry (SIMS)
- Laser Desorption (LD) → MALDI
- Plasma Desorption (PD)
- Thermal Desorption (Thermospray)
- Atmospheric Pressure Chemical Ionization (APCI) and photoionization (APPI)
- Electrospray ionization (ESI)

## 3. Fase condensata a pressione ambiente

- DESI
- DART
- DAPCI
- DAPPI
- Derivati DESI

# Cromatografia e Spettrometria di Massa

Consente di misurare le masse molecolari (nominali o esatte) e di ottenere dei profili di frammentazione che sono specifici per ciascun composto quindi permette di effettuare il riconoscimento di una sostanza nota, di individuare la formula di struttura di composti incogniti, di ottenere informazioni strutturali.

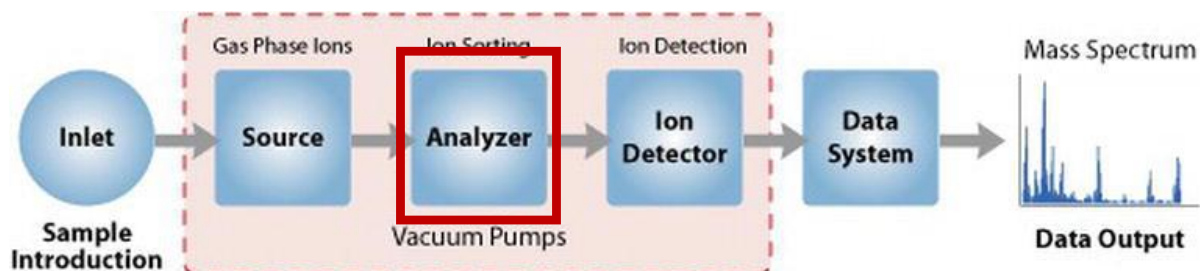

## MS

Consente di misurare le masse molecolari (nominali o esatte)

## Massa Tandem MS/MS

Si possono effettuare esperimenti di MS/MS sfruttando in serie due spettrometri di massa tra i quali si inserisce una cella di collisione

**FRAMMENTI = TRANSIZIONI IONE PRECURSORE / IONE MOLECOLARE**

Analizzatore	Simbolo	Principio di separazione
Electric sector	E or ESA	Kinetic energy
Magnetic sector	B	Momentum
Quadrupole	Q	m/z (trajectory stability)
Ion trap	IT	m/z (resonance frequency)
Time-of-flight	TOF	Velocity (flight time)
Fourier transform ion cyclotron resonance	FTICR	m/z (resonance frequency)
Fourier transform orbitrap	FT	m/z (resonance frequency)

# Gas chromatography-mass spectrometry - GC-MS



Modalità di acquisizione:

## Full scan (FS)

Ampio range m/z  
Scansione lunga  
Bassa sensibilità

## Selected Ion Monitoring (SIM)

Range di m/z ristretto (o singolo)  
Scansione breve  
Alta sensibilità

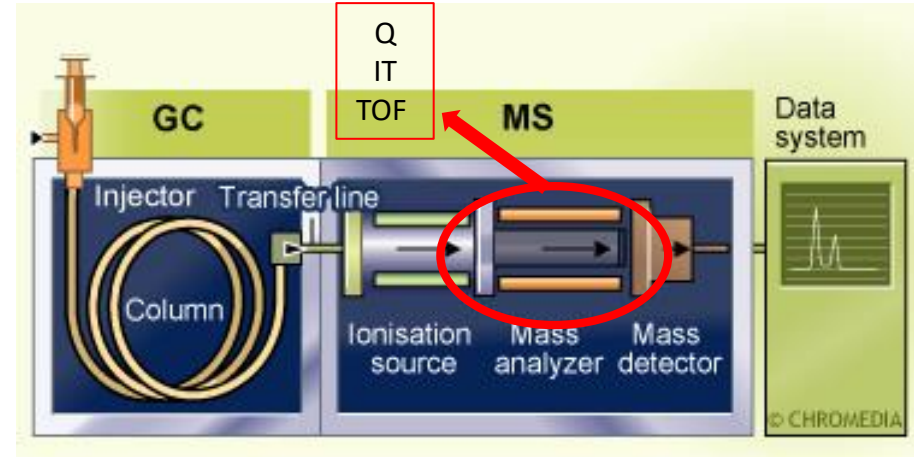
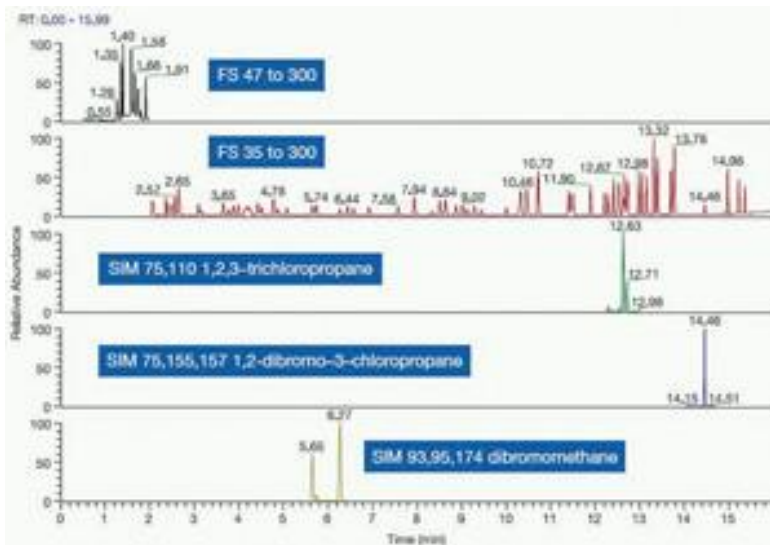

## Identificazione:

- ✓ Tempo di ritenzione
- ✓ Spettro di massa
  - Picco BASE
  - Frammenti
  - Rapporto tra i frammenti

Standard

Banca Dati

# GC-MS - Applicazioni

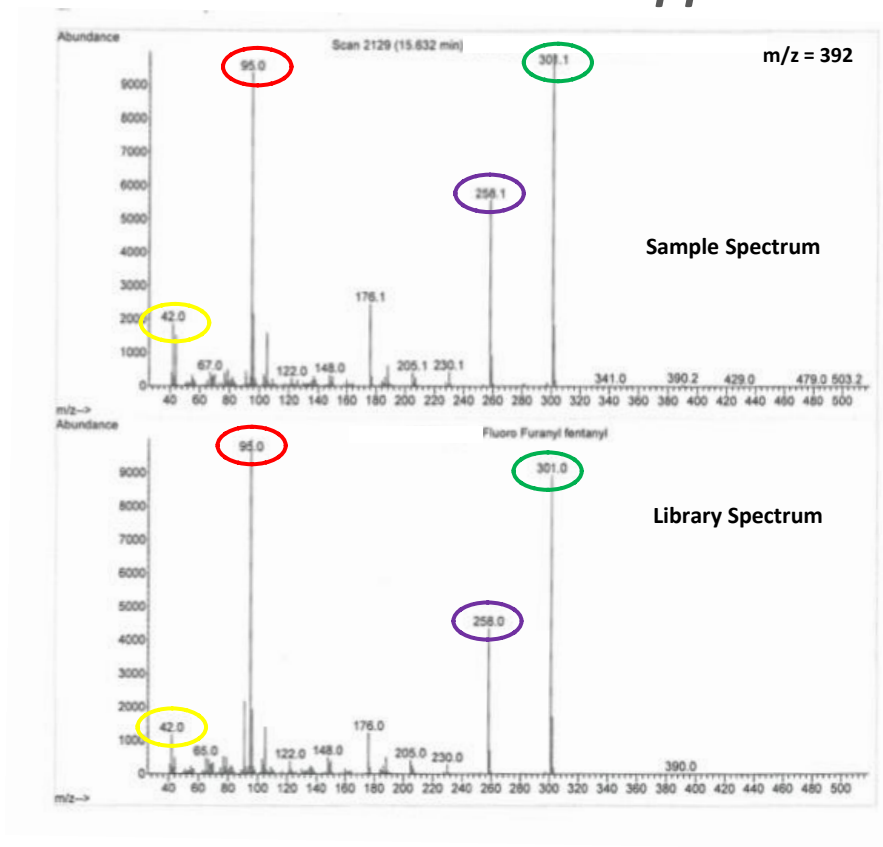
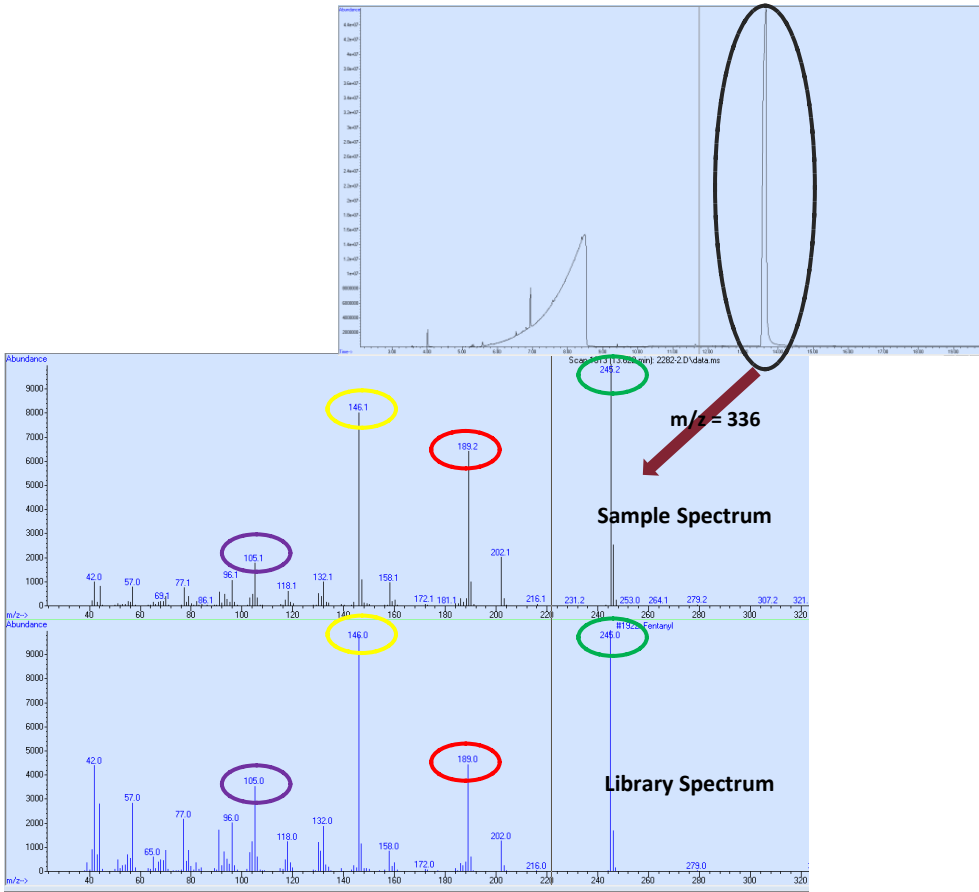

# Liquid chromatography-(tandem) mass spectrometry - LC-MS(/MS)

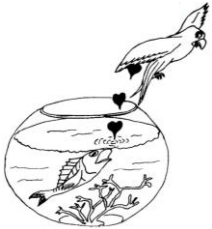

## Identificazione:

- ✓ Tempo di ritenzione
- ✓ Spettro di massa
  - Transizione ione precursore/ione frammento
  - Rapporto tra le transizioni più intense

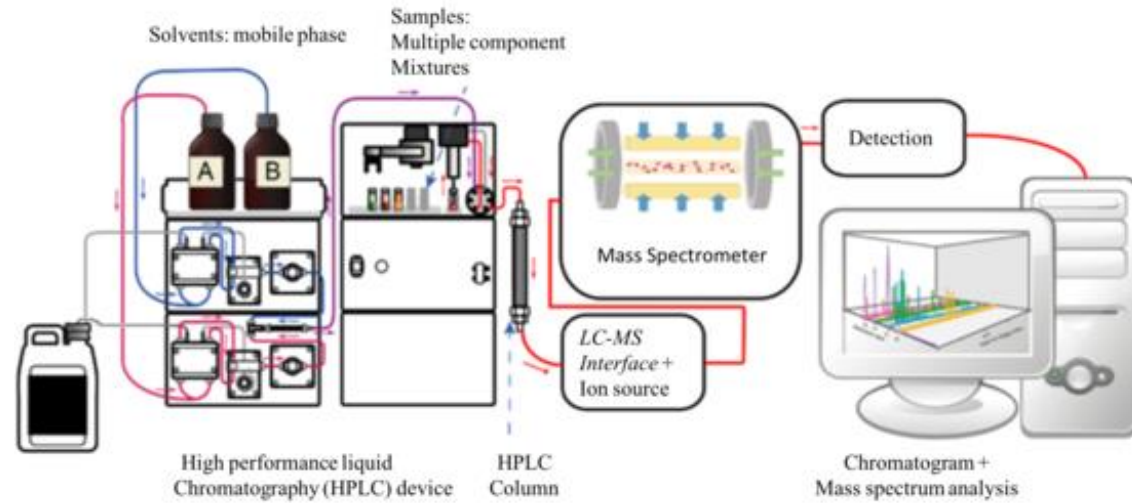

*MS*

*MS/MS*

*MS<sup>n</sup>*

**Targeted, Semi-Targeted**

# SISTEMI DI INTERFACCIAMENTO

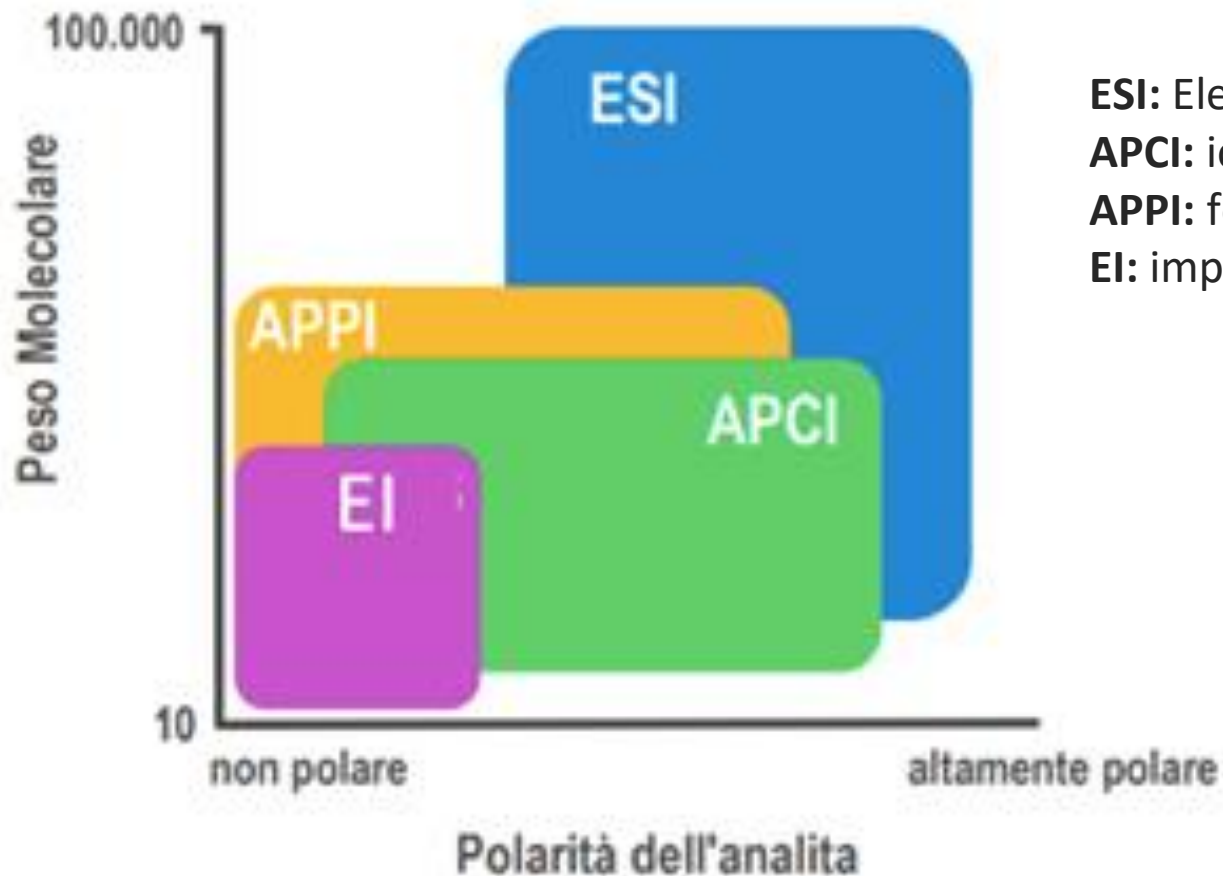

**ESI:** Electrospray

**APCI:** ionizzazione chimica a P atm

**APPI:** fotoionizzazione

**EI:** impatto elettronico

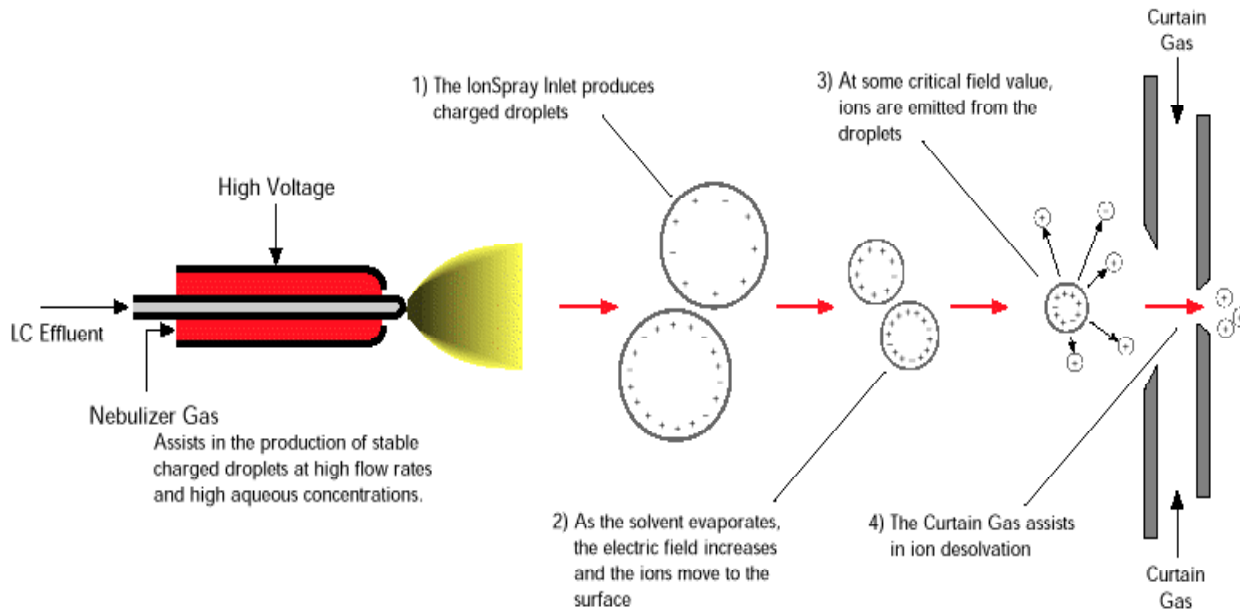

← ESI

APCI →

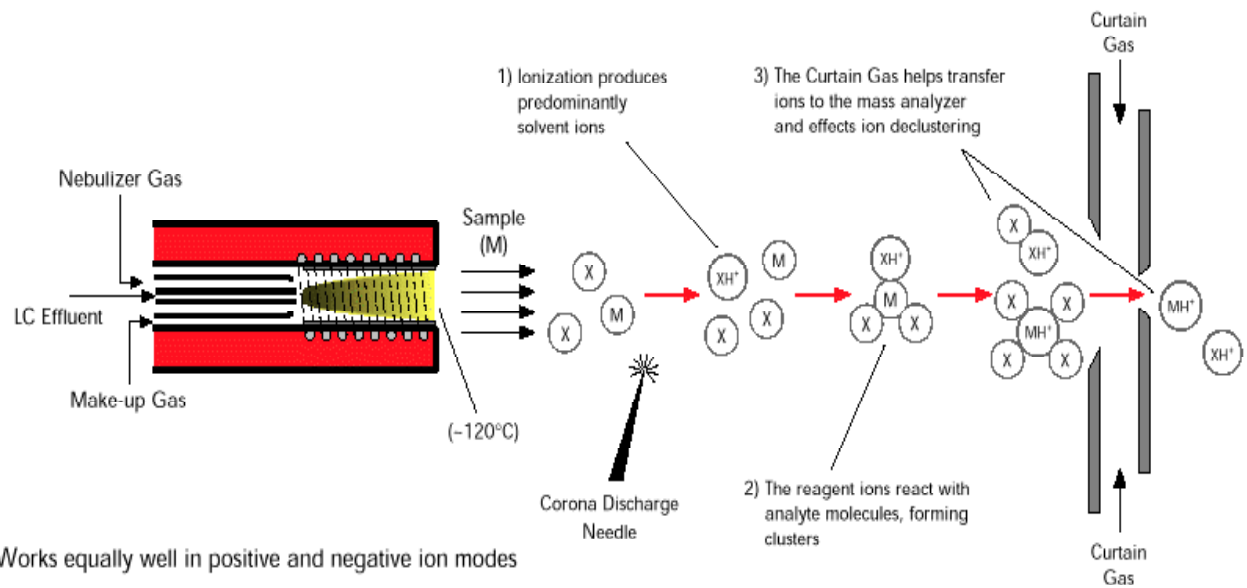

Works equally well in positive and negative ion modes

<sup>1</sup>Atmospheric Pressure Chemical Ionization  
X = solvent molecules, e.g. H<sub>2</sub>O, NH<sub>3</sub>, etc.



# QUADRUPOLO

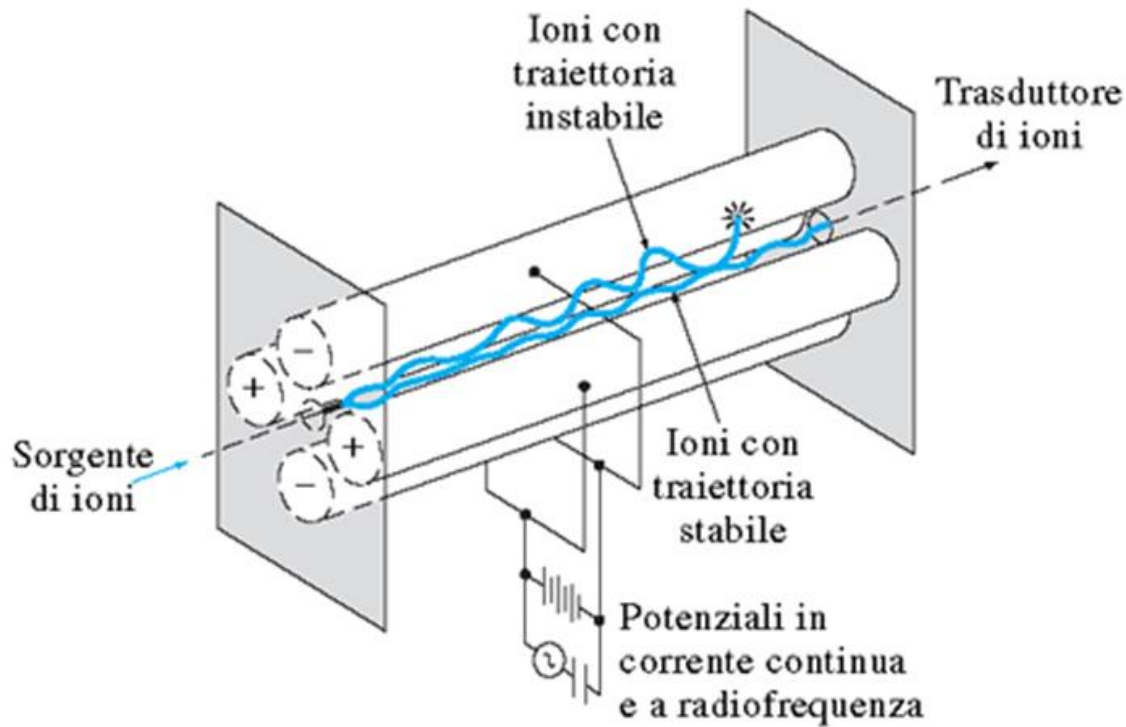

**FIGURA 11-6** Uno spettrometro di massa a quadrupolo.

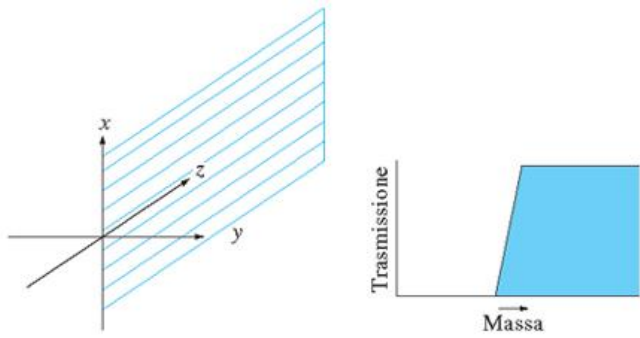

(a)

a) Filtro passa-alto

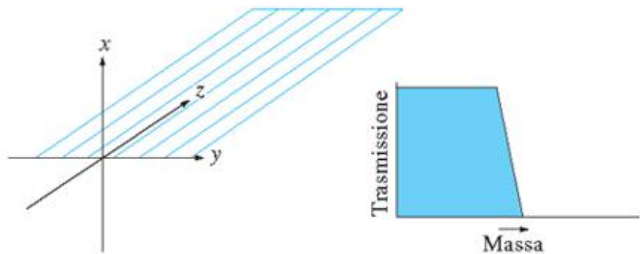

(b)

b) Filtro passa-basso

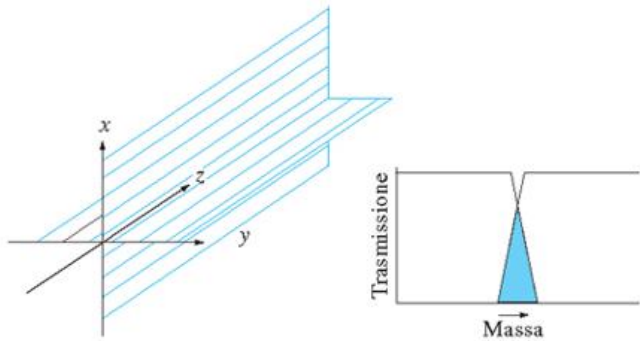

(c)

c) Banda passante

# Modalità di acquisizione MS/MS

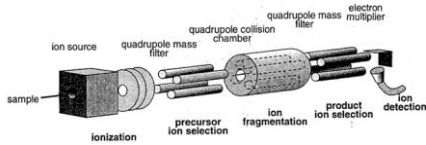

## triple quadrupole

- ✓ Full Range
- ✓ Multiple Ion
- ✓ Single reaction monitoring (SRM)
- ✓ Multiple reaction monitoring (MRM)
- ✓ Precursor Ion Scan
- ✓ Product Ion Scan
- ✓ Neutral Loss (NL)

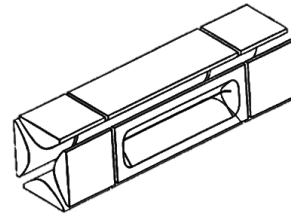

## triple quadrupole Q trap

## Linear Ion Trap (LIT)

- ❖ All triple quadrupole's acquisitions mode
- ✓ Enhanced MS (EMS)
- ✓ Enhanced Resolution (ER)
- ✓ Enhanced Product Ion (EPI)
- ✓ Enhanced Multi-Charge (EMC)
- ✓ MS/MS/MS (MS<sup>3</sup>)
- ✓ Time Delayed Frag (TDF)
- ✓ Scheduled MRM™ algorithm

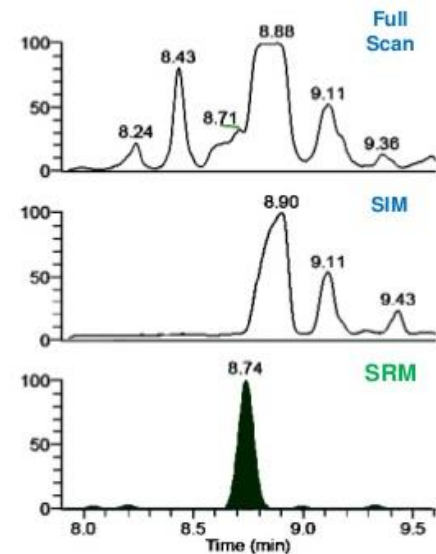

# HPLC-MS(/MS) - Applicazioni

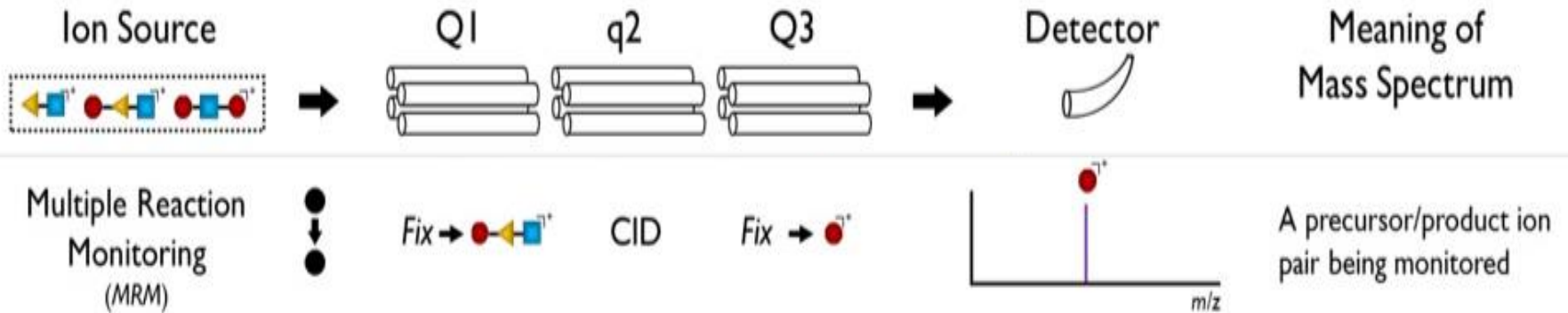

# Tandem MS $\rightarrow$ SRM

CID is used to fragment the 237 Da (or  $m/z$ ) ions peak into these  $m/z$  value

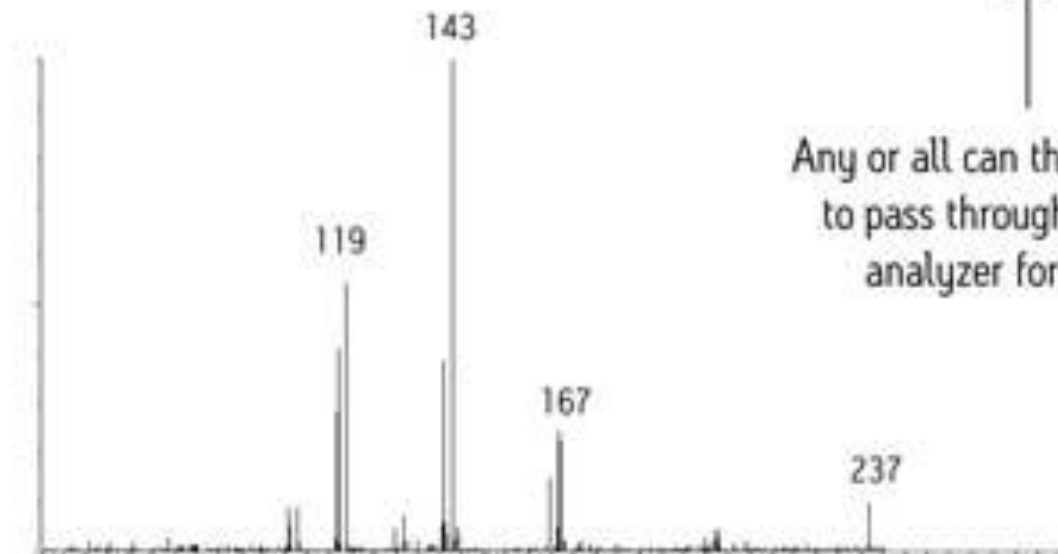
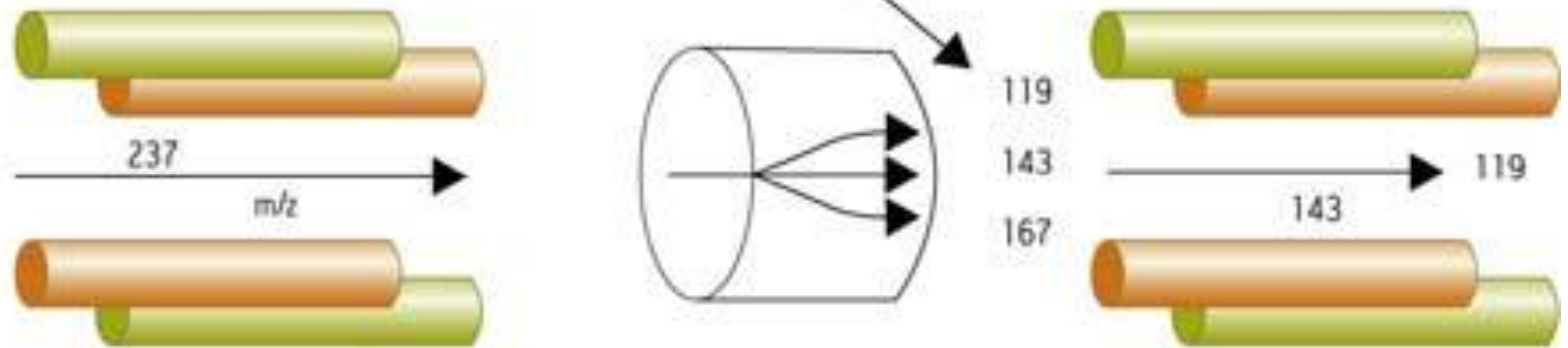

Any or all can then be allowed to pass through the second analyzer for detection

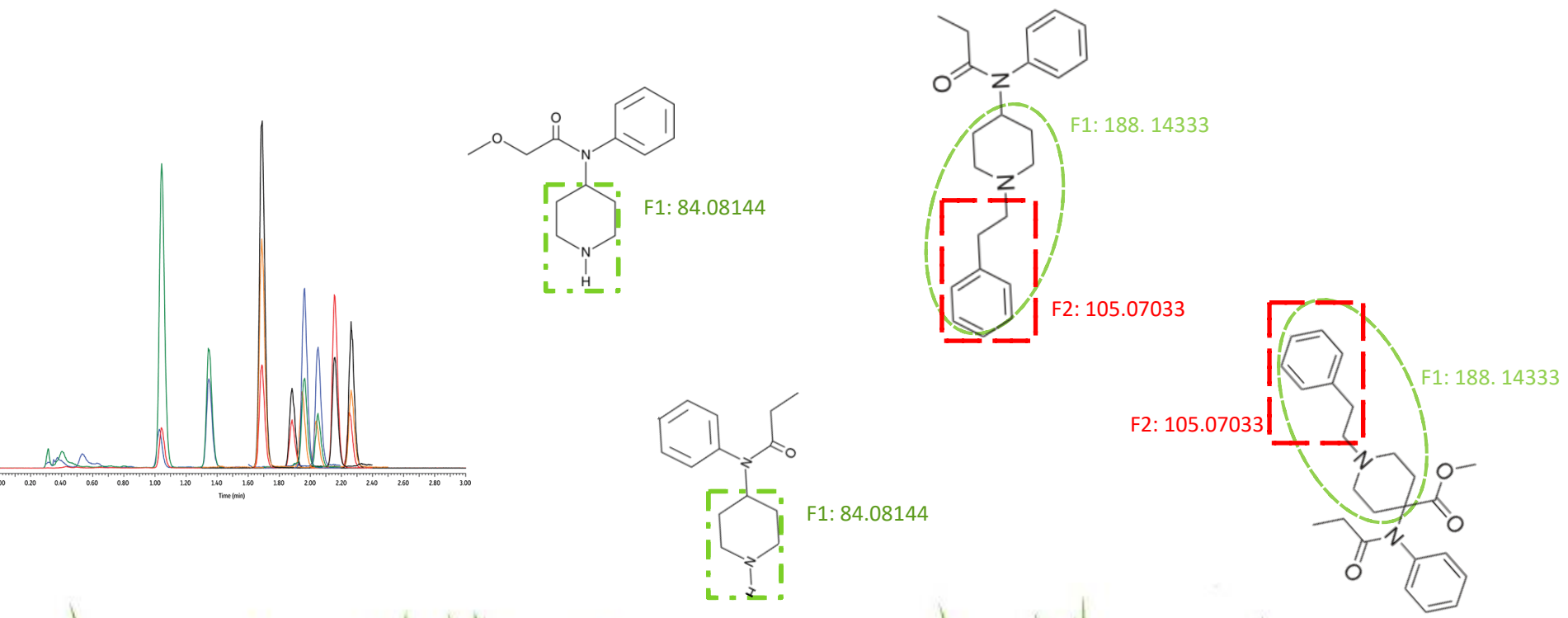
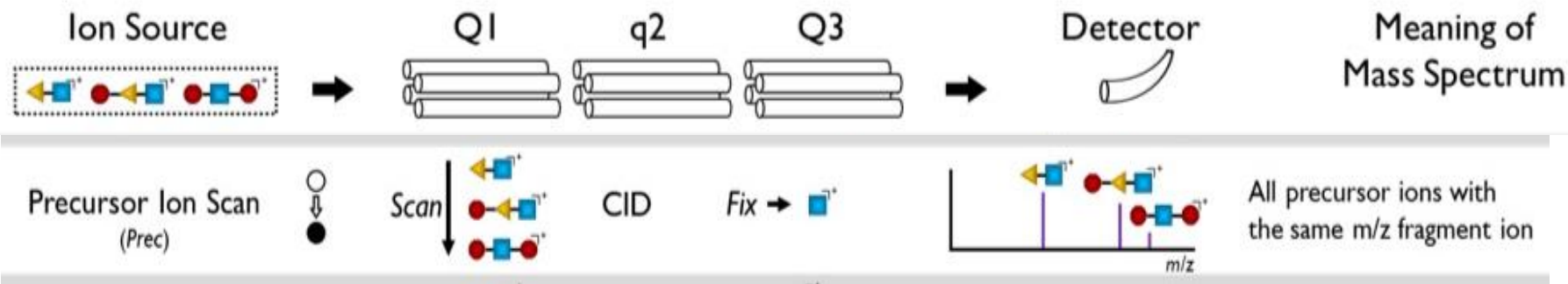

# ESEMPIO: IL CASO DELLE SOLFONAMMIDI

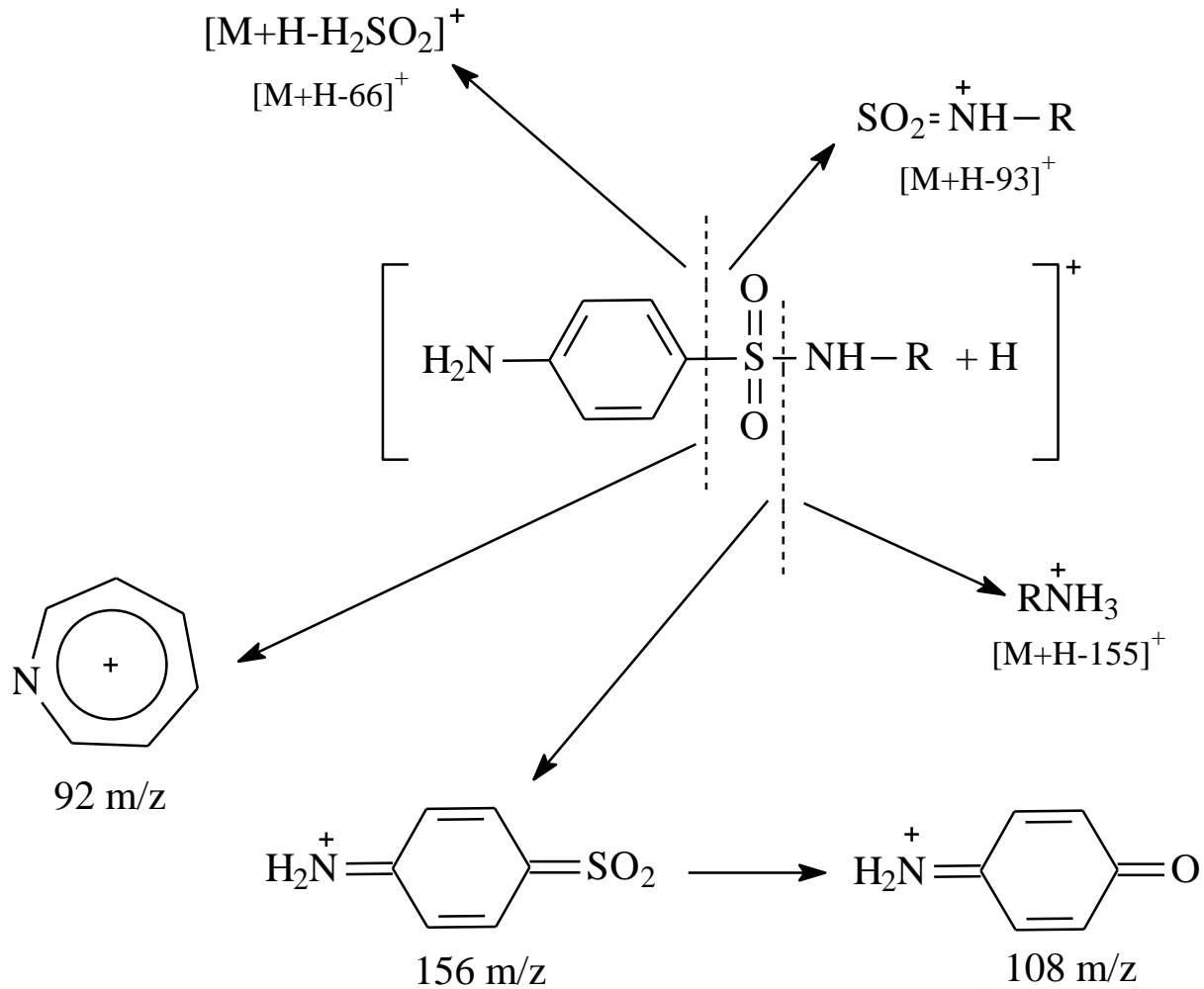

# SPETTROMETRIA DI MASSA AD ALTA RISOLUZIONE (e accuratezza)

- Standard analitici spesso non disponibili
- Metaboliti sono spesso sconosciuti
- Tecniche di screening immunometriche non efficaci
- Basse concentrazioni

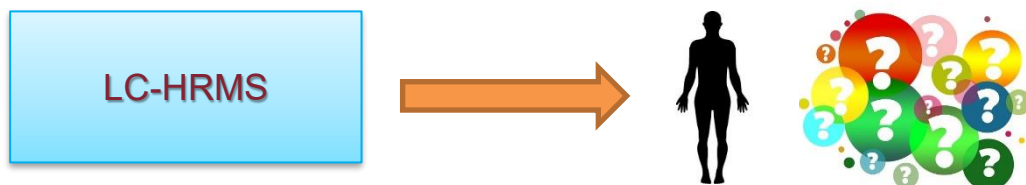

La spettrometria di massa ad alta risoluzione (HRMS) è uno strumento essenziale per lo screening e l'identificazione di nuove sostanze o per l'analisi di molecole ad alto peso molecolare



# Spettrometria di massa ad alta risoluzione ed accuratezza (HRAMS)

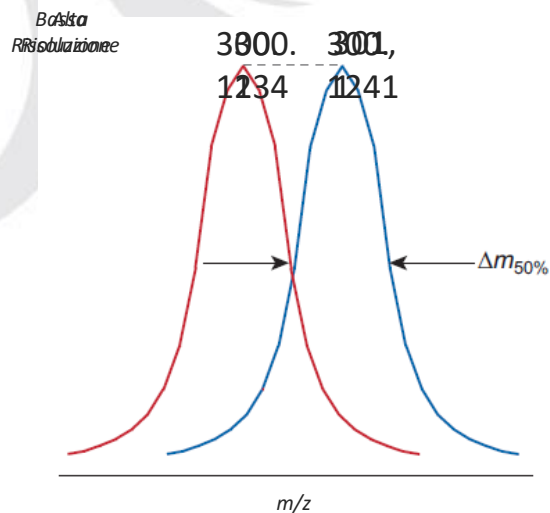

Potere risolutivo (R) >10.000 (FWHM)

Accuratezza di massa <5 ppm

$$\text{Risoluzione} = m_2 - m_1 = \Delta m_{50\%}$$

$$R = \frac{m}{\Delta m_{50\%}}$$

$$\text{Accuratezza di massa} = \frac{(\text{massa esatta}) - (\text{massa osservata})}{(\text{massa esatta})} 10^6 \text{ ppm}$$

# RISOLUZIONE

Il potere risolutivo di uno strumento consiste nella capacità di separare due picchi di massa  $M_n$  ed  $M_m$ . Si sceglie arbitrariamente e per convenzione di misurare il potere risolutivo di uno strumento su picchi separati tra loro da una valle alta il 10% dell'altezza dei picchi stessi.

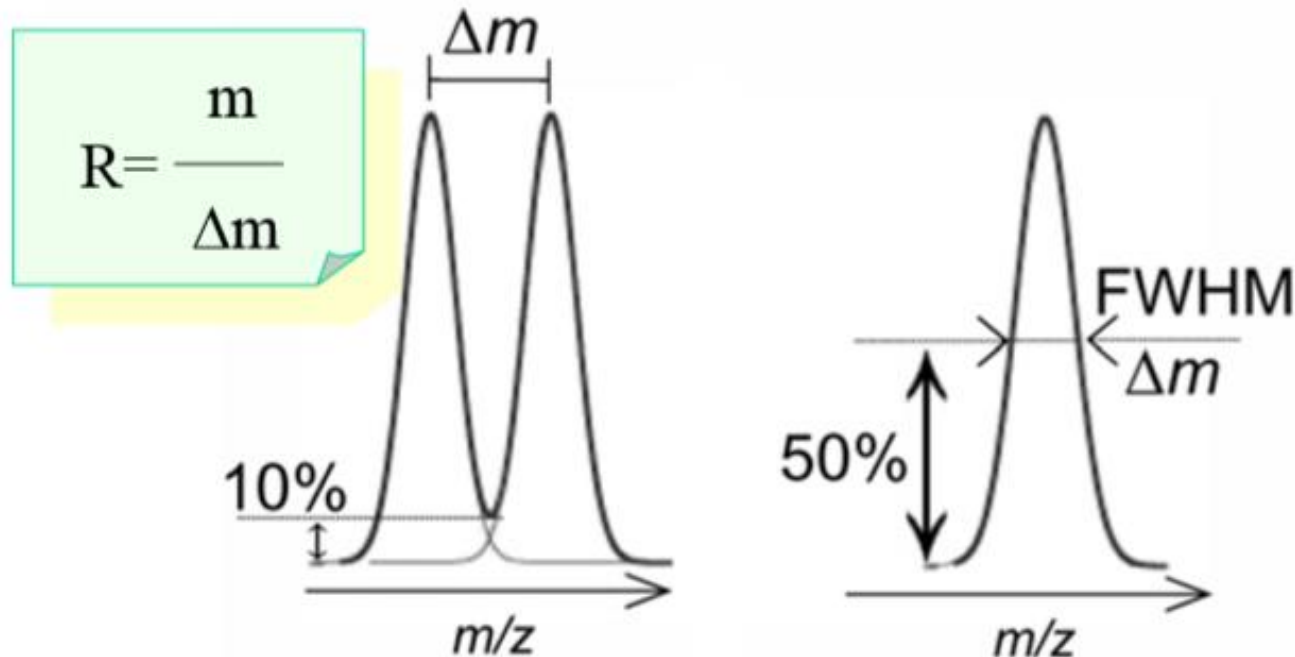

In tali condizioni il potere risolutivo e' dato da:

$$R = \frac{M_n}{M_n - M_m}$$

Uno strumento si definisce “a bassa risoluzione” se separa masse unitarie fino a 2000 m/z ( $R = 2000/[2000-1999]=2000$ ).

Uno strumento ad alta risoluzione con  $R=20000$  puo' distinguere tra i picchi di  $C_{16}H_{26}O_2$  e  $C_{15}H_{24}NO_2$ .

$$R = \frac{250.1933}{250.1933 - 250.1807} \approx 20000$$

## Bassa risoluzione vs alta risoluzione

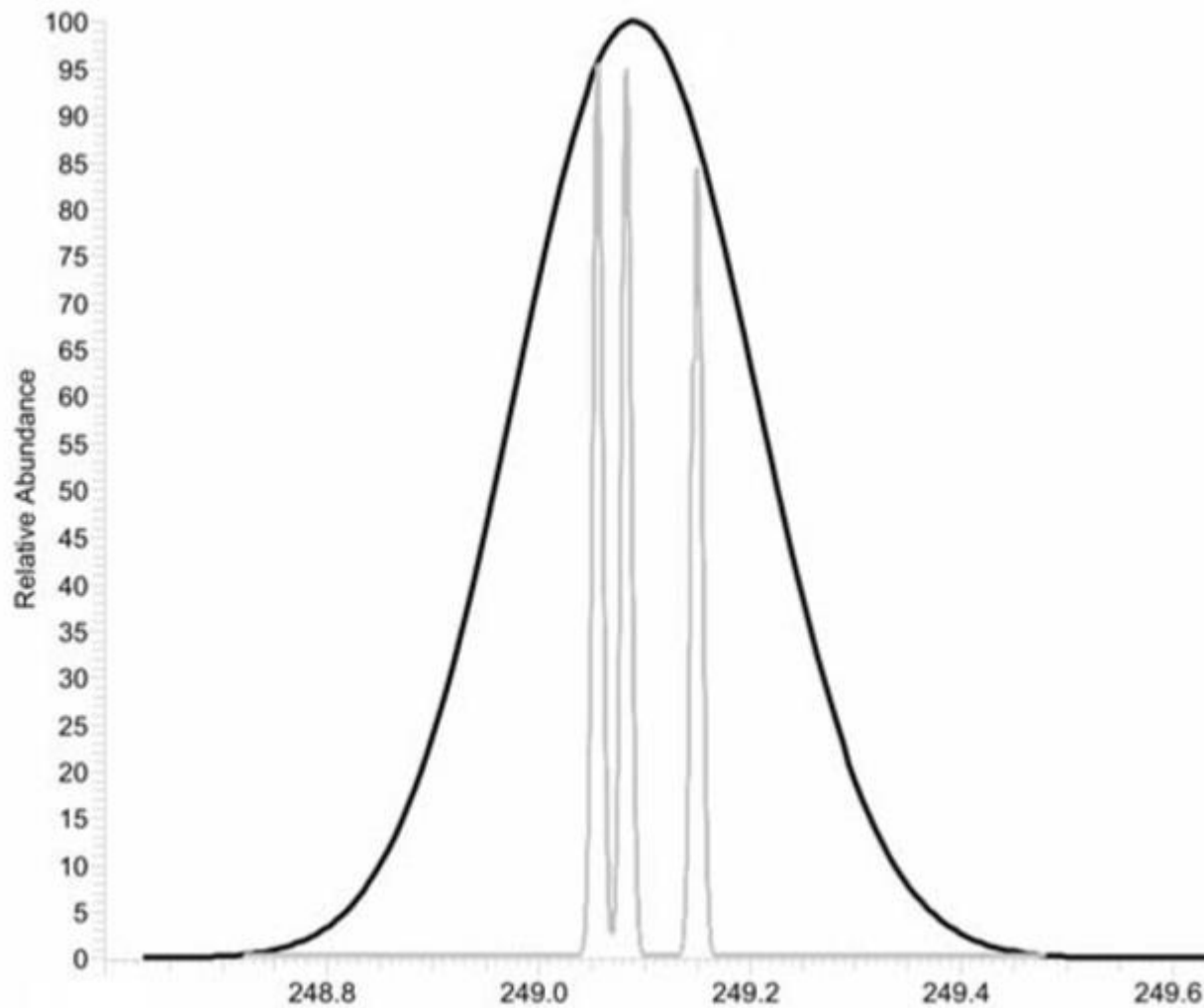

# Analizzatori di massa ad alta risoluzione

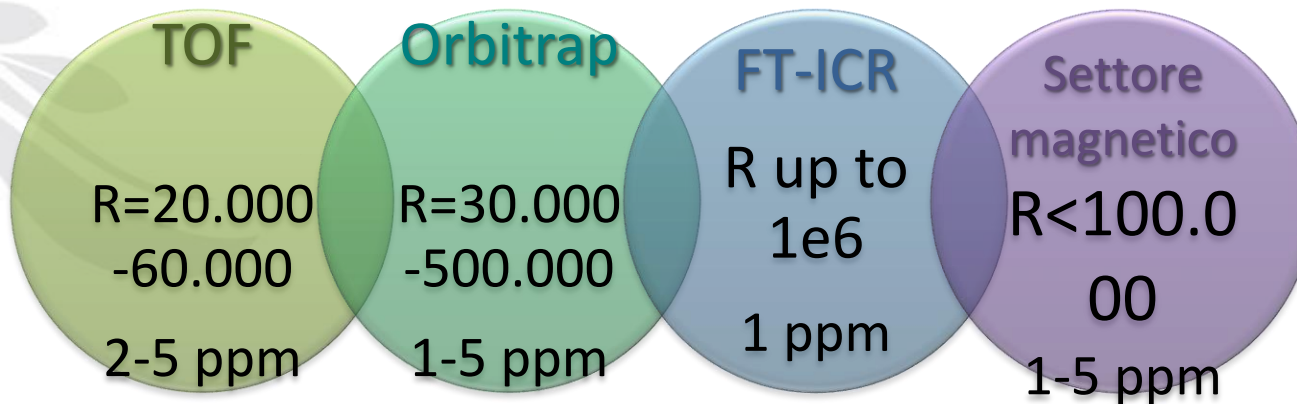

Gli analizzatori di massa separano gli ioni con diverse  $m/z$  attraverso l'applicazione di campi elettrici e/o magnetici costanti, pulsati o variabili nel tempo.

- ❖ FT-ICR estremamente costoso e complicato; uso limitato ad applicazioni complesse
  - ❖ Settore magnetico difficilmente accoppiabile con LC; applicazioni specifiche (analisi diossine tramite GC-HRMS)
- TOF-MS e Orbitrap-MS sono ad oggi le tecniche più diffuse ed utilizzate

# Time of flight (TOF)

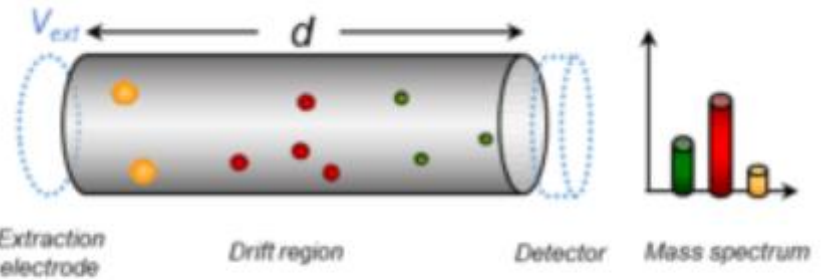
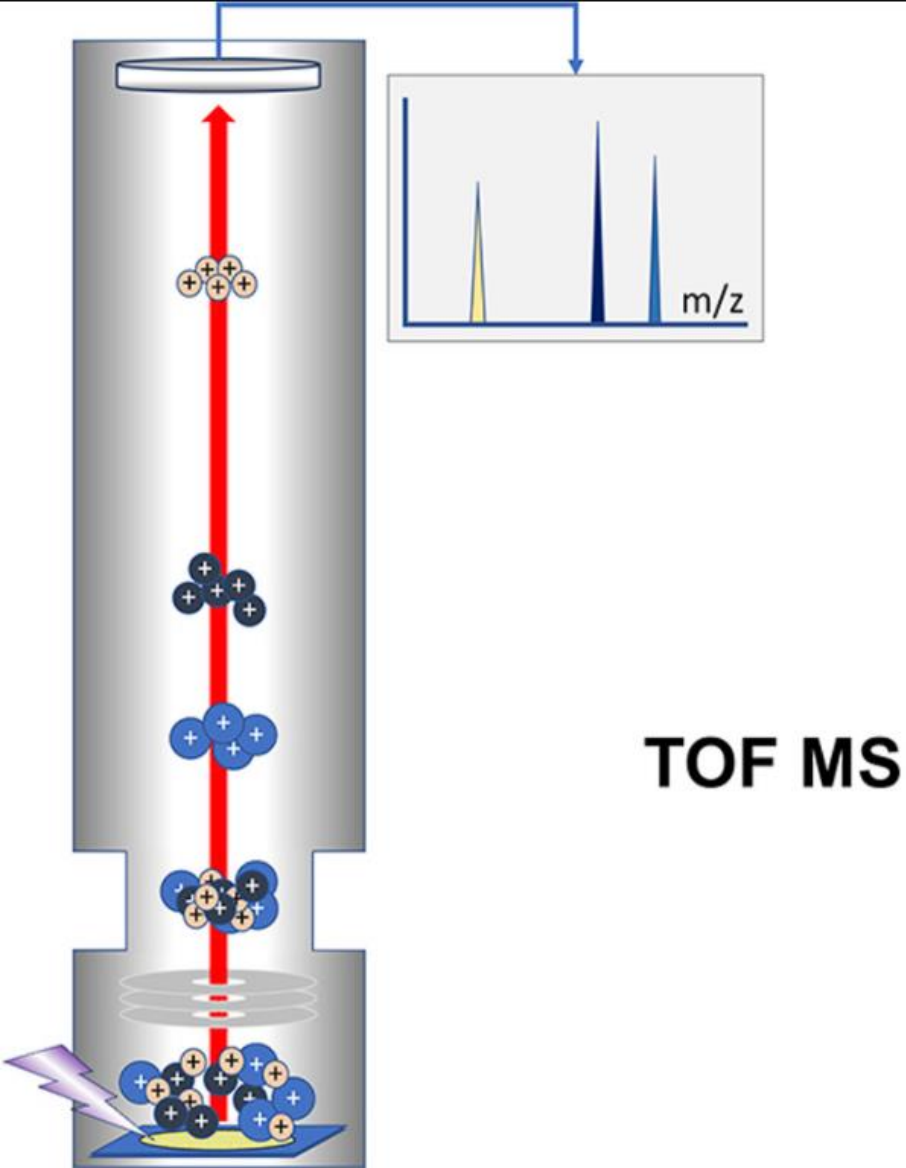

$$E = qV_{ext} = \frac{1}{2}mv^2$$

$$t = d \left( \frac{m}{2qV} \right)^{1/2} \propto m^{1/2}$$

## TOF MS

# TOF + Reflectron

La separazione si basa sul diverso tempo di volo di ioni con diverso rapporto  $m/z$ .

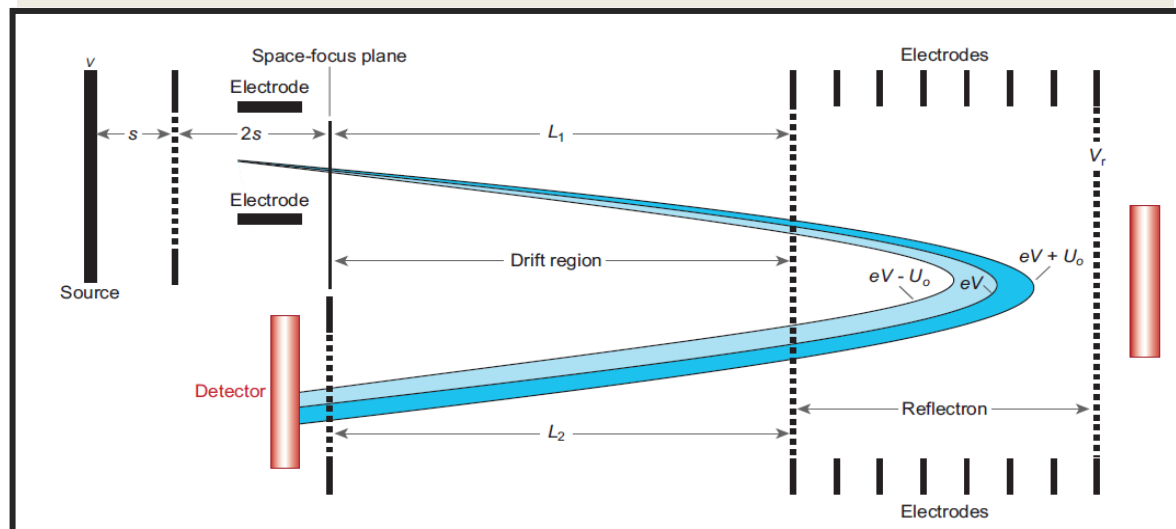

- Estrazione ritardata: compensazione velocità iniziale
- Reflectron: incremento della distanza di volo e riduzione della distribuzione di energia cinetica
- Accelerazione ortogonale: interfaccia ESI



Incremento di  
risoluzione e  
accuratezza di massa

# ORBITRAP

La tecnica si basa sulla misurazione delle frequenze di oscillazione degli ioni. Attraverso la trasformata di Fourier il segnale nel dominio del tempo viene convertito in uno spettro di  $m/z$

$$U(r, z) = \frac{k}{2} \cdot \left\{ z^2 - r^2 / 2 + R_m^2 \cdot \ln(r / R_m) \right\}$$

$$\omega_z = \sqrt{\frac{k}{m/z}}$$

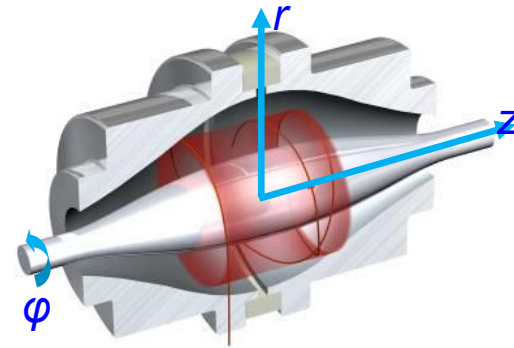

- Gli ioni sono intrappolati in un campo elettrostatico; l'elettrodo centrale è mantenuto ad alto potenziale mentre su una parte di quello esterno viene applicato un potenziale pulsato. L'altra parte dell'elettrodo esterno è utilizzata per misurare l'immagine indotta dagli ioni che oscillano all'interno della trappola.
- La frequenza degli ioni è proporzionale a  $m/z$



# TOF vs ORBITRAP

	TOF	ORBITRAP
Potere risolutivo		✓
Accuratezza di massa		✓
Velocità di scansione	✓	
Limite superiore $m/z$	✓	
Sensibilità	✓	✓
Switch polarità	✗	✓

- TOF permette di registrare più di 50 scansioni al secondo ; ottimale per accoppiamento con UHPLC.
- Orbitrap offre una risoluzione notevolmente maggiore. Possibilità di switching ma potere risolutivo scende
- TOF in principio non ha limiti superiori di  $m/z$ ; Orbitrap ottimale per ioni con  $m/z < 5000$ .

# MS/MS

- Spettrometria di massa tandem QTOF, Q-exactive, LTQ-Orbitrap

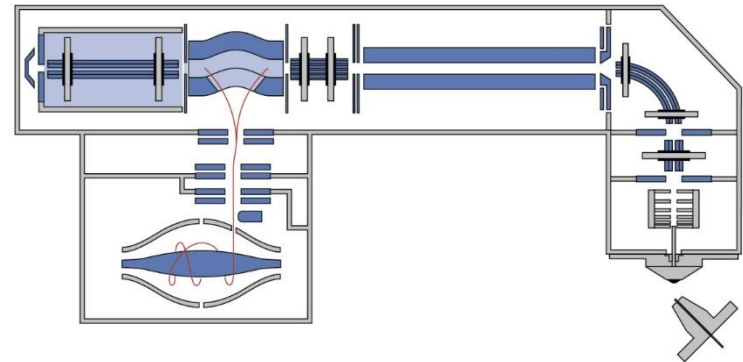
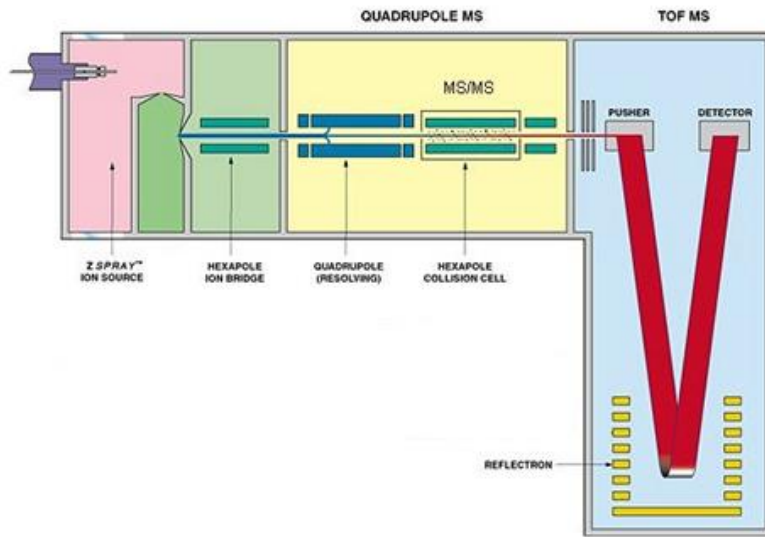

# HRMS ed identificazione

C = 12.0000

H = 1.0078

O = 15.9949

N = 14.0031

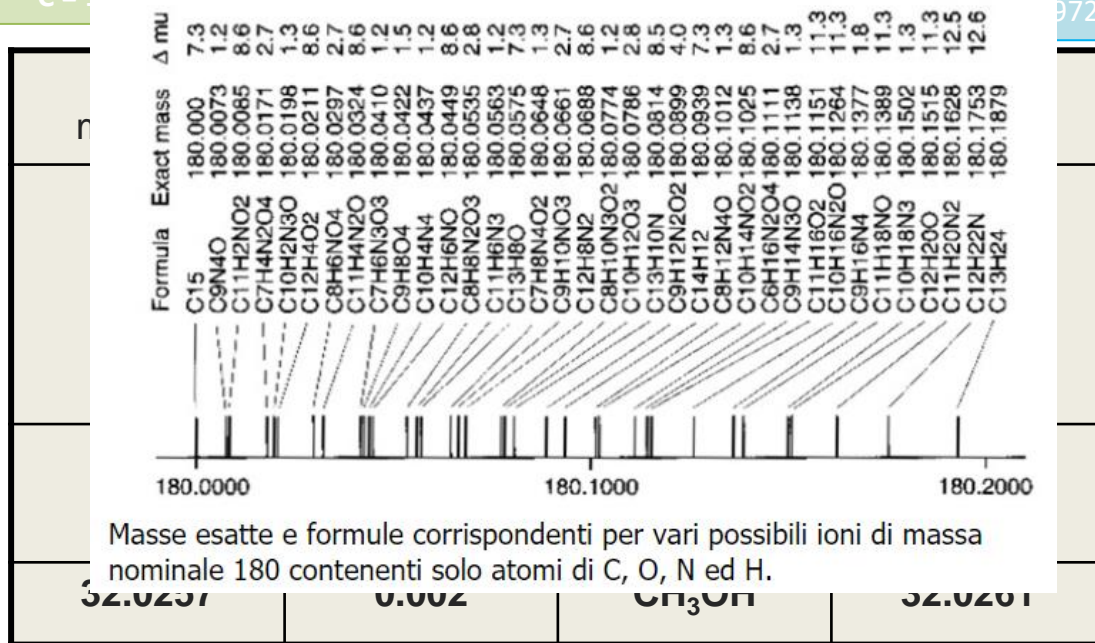

# HRMS e selettività

230,1172

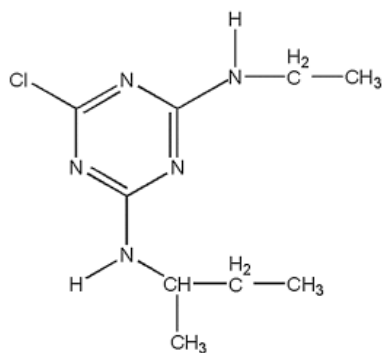

230,1532

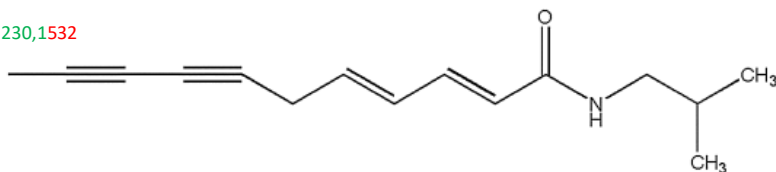

Sebutilazina (C<sub>9</sub>H<sub>16</sub>ClN<sub>5</sub>) e neopellitorina (C<sub>15</sub>H<sub>19</sub>NO)

	Q1	Q3
Sebutilazina	230	174
Nepellitorin		104
a	230	174
		104

[1] Schürmann, A., Dvorak, V., Crüzer, C., Butcher, P., Kaufmann, A., *Rapid Commun. Mass Spectrom.* 23(8), 1196–1200 (2009)

# HRMS e sensibilità

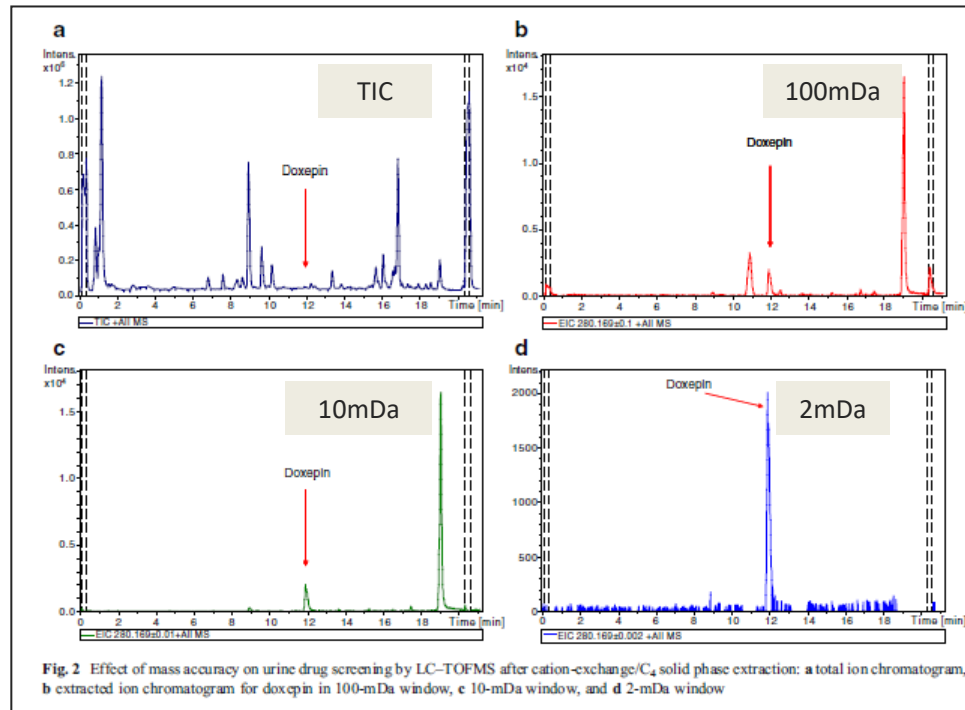

# Acquisizione full scan

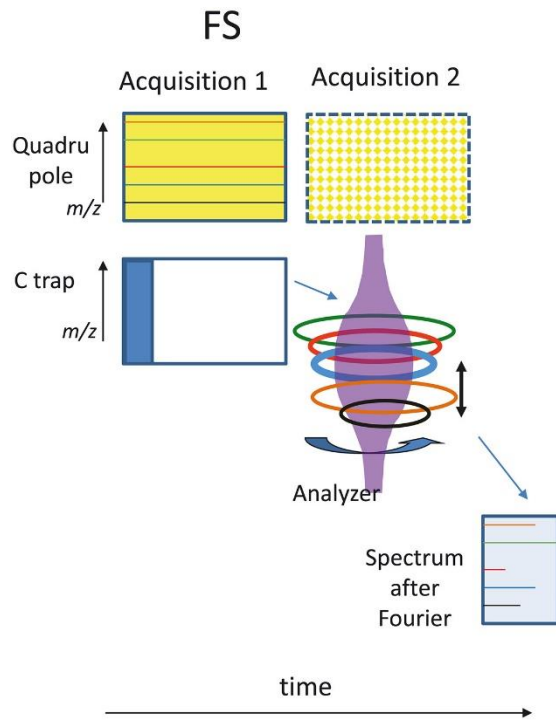

TOF MS

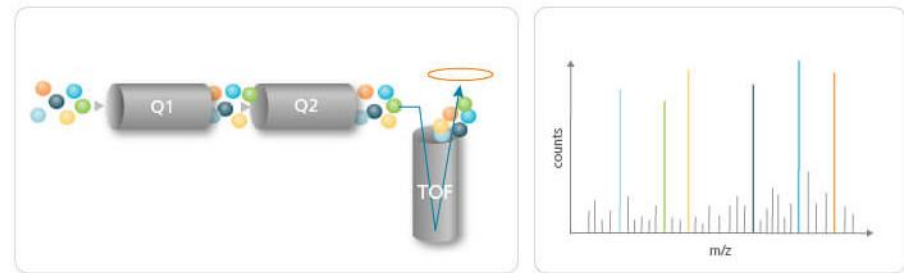

- ✓ Misura della massa accurata
- ✓ Pattern isotopico
- ✓ Tempo di ritenzione



FORMULA BRUTA e  
grado di insaturazione  
(DBE)

# Modalità di acquisizione MS/MS

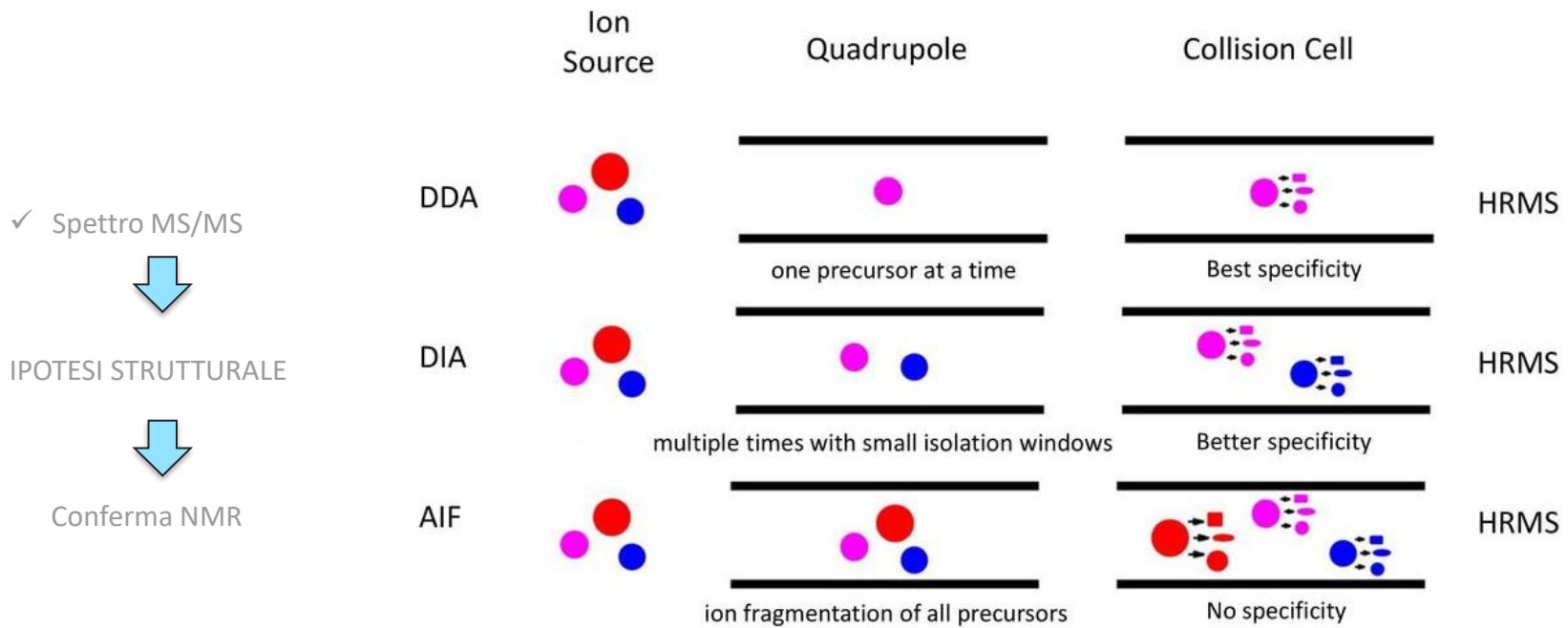

# Workflow di analisi

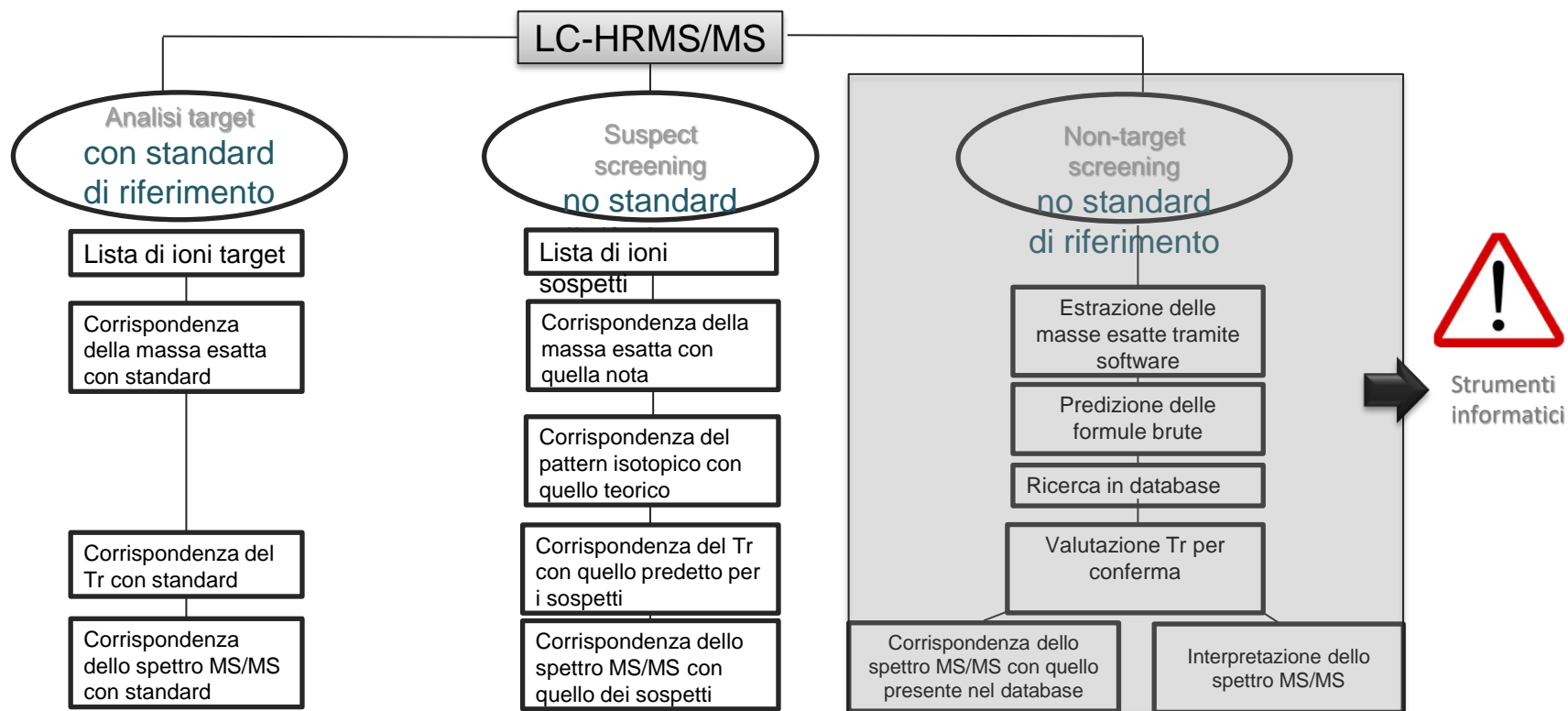

[2] Pasin D., Cawley, A., Bidny, S., Fu, S., *Anal Bioanal Chem.* 409, 5821-5836 (2017)



# ANALYTICAL PROCEDURE



Sample collection and pretreatment (ISs)  
HPLC-MS/MS Analysis  
with API 2000 Perkin-Elmer  
ESI+, Turboionspray, MRM (Multi reaction monitoring)

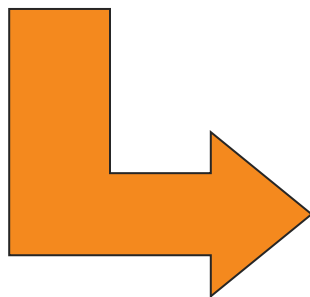

μ-SPE clean-up

