

ZEBRAFISH: alimentazione

- dieta naturale costituita da zooplancton e insetti
- in Facility utilizzo di mangime secco pellettato o a fiocchi con aggiunta di “live diets” come

Vantaggio nutrizionale live diets

- profilo amminoacidico per sostenere la crescita del pesce
- fonte digeribile e biodisponibile della nutrizione
- determinazione di un comportamento di predazione per il pesce
- additivati per personalizzare il profilo nutrizionale (con vitamina C e amminoacidi)

Artemia





Alimentazione zebrafish



Food in the nature



Food in the lab

Insects (like ants) that have fallen into the water

crustacean larvae and other zooplankton and phytoplankton



prefer to feed at surface – upward gaping mouth

but chase prey also across the water
Artemia larvae as live food = tank enrichment!



Feeding

- **Larval Diets**

- Dry - micro-capsule
- Live - *Paramecia*, *Artemia* naupli, rotifers



- **Adult Diets**

- Dry - Flake, pellet, crumble, freeze dried
- Live - *Artemia* (brine shrimp)
- Varied diet recommended

- **2-4 feedings/day**

- Do Not Overfeed





Behaviour

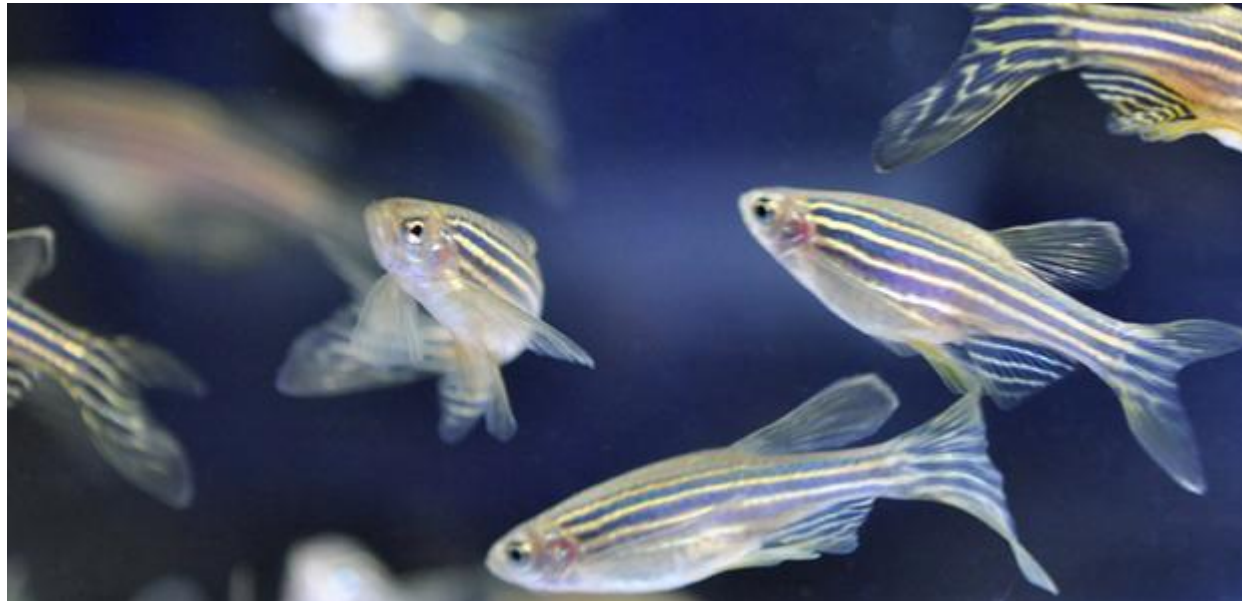

https://www.youtube.com/watch?v=F7JNB2k_S00

- Pesce onnivoro diurno
- Ottimo nuotatore
- Pesce molto territoriale con gerarchia sociale
- Pesce gregario per cui sono fondamentali le interazioni
- Gruppi misti maschi e femmine



Zebrafish e benessere



Fonti di stress:

▪ trasporto

avviene in buste di plastica contenenti pillole di ossigeno, con una densità di 10/2 litri



▪ manipolazione

l'impiego di retini durante il cambi di vaschetta, o nel passaggio da una vaschetta all'altra.

Un'errata manipolazione causa stress, ma anche possibili lesioni al muco di rivestimento superficiale esponendo l'animale a possibili infezioni



Fonti di stress:

▪ **sovraffollamento**

comporta un notevole aumento di stress, con conseguente immunodepressione, aumento di cataboliti nell' H_2O , ridotta fertilità, esposizione ad infezioni.

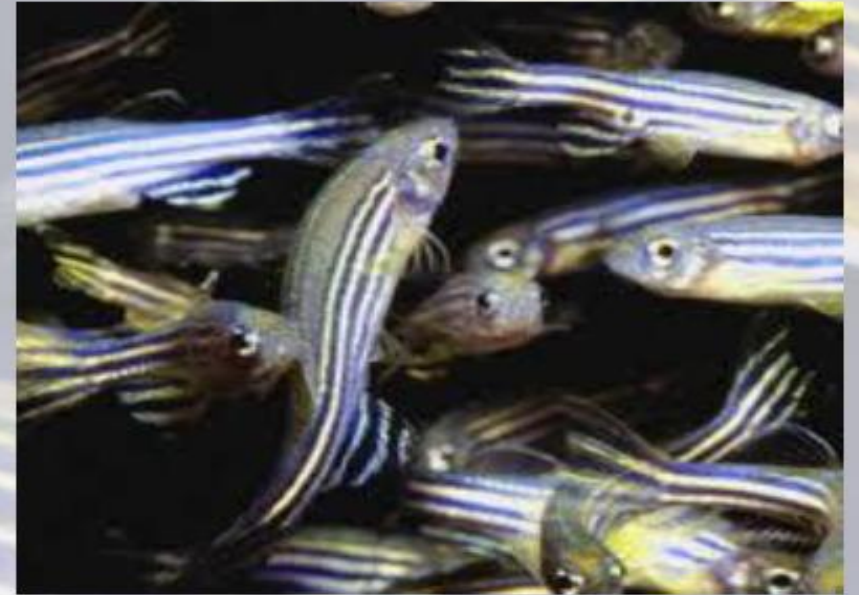

▪ **malnutrizione**

immunodepressione, scarsa o assente fertilità, esposizione ad infezioni e malattie.

▪ **modifiche dei parametri dell' H_2O**

temperatura, ossigeno e salinità.

Come riconoscere lo stress

Osservare :
gli animali, il loro comportamento e l' andamento della colonia
(infezioni, calo nell' ovodeposizione, ristagno di cibo causato da
ridotta assunzione)

alcuni esempi



- ridotta assunzione di cibo
- calo della riproduzione
- maggiore incidenza di infezioni
- squame di rivestimento del corpo



Segni clinici di malattia o di stress



Cambiamenti comportamentali

- Perdita dell'appetito
- Letargia
- Tendenza all'isolamento
- Animali tendono a nascondersi
- Respirazione in superficie
- Pinne bloccate
 - Alterazioni nell'equilibrio
- Attività natatoria alterata
- Cambi della frequenza respiratoria



Arricchimento ambientale



- Miglioramento benessere.
- Promuove il comportamento naturale.
- Riduce le stereotipie.

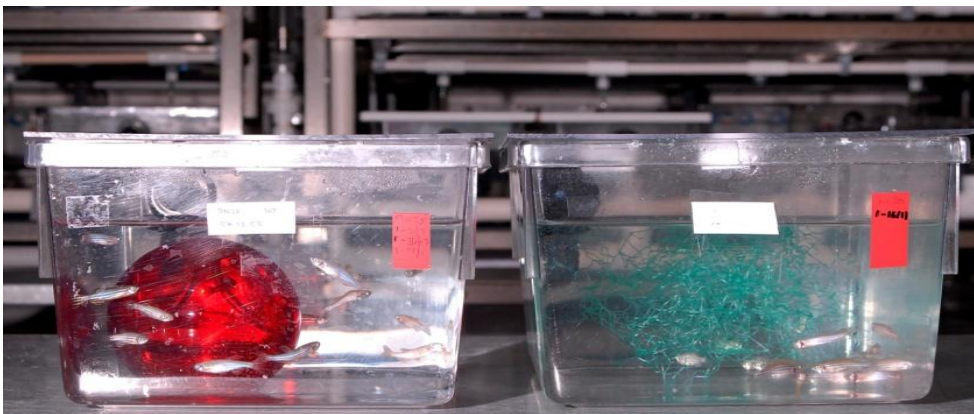

Common enrichment: plastic grass or plastic leaves or Artemia or marbles

* ZEBRAFISH: breeding

- * Riproduzione in natura con arrivo delle piogge
- * Riproduzione in Facility tutto l'anno
- * Raggiungimento forma adulta in 3 mesi
- * Fertilizzazione esterna (in acqua)
- * Assenza di cure parentali degli embrioni

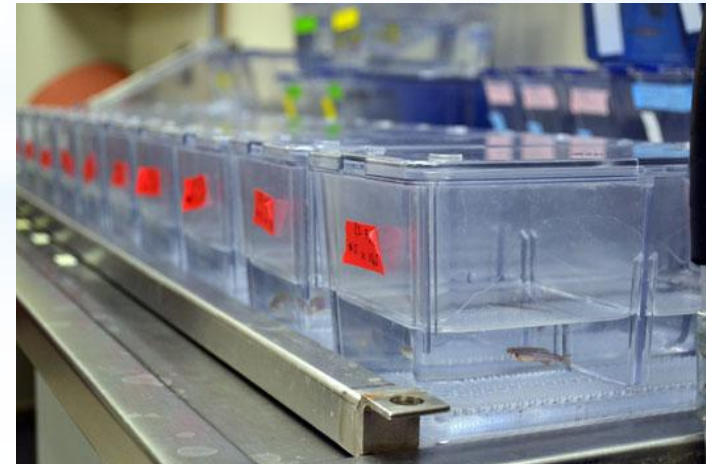



Dimorfismo sessuale

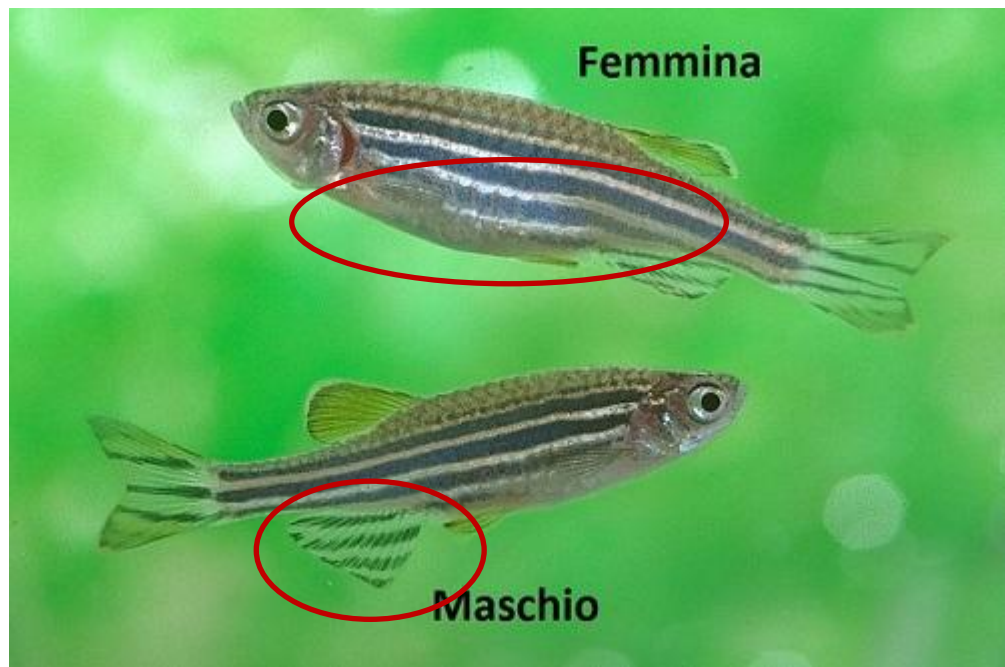

Breeding - stimoli scatenanti la riproduzione:

- Ambientali
- Olfattivi
- Contatto fisico



TECNICHE DI ACCOPPIAMENTO

- Pesci lasciati insieme nel tardo pomeriggio del giorno precedente.....non è possibile sapere quando avviene la deposizione puoi avere uova a diversi stadi
- Accoppiamento nello stesso giorno subito dopo l'accensione delle luci.....poco produttivo ma è possibile raccogliere uova fertilizzate da poco
- **Pesci lasciati insieme nel pomeriggio del giorno precedente ma utilizzando un separatore..... è possibile raccogliere uova fertilizzate in mattinata e tutte allo stesso stadio.**



Metodo migliore

RIPRODUZIONE

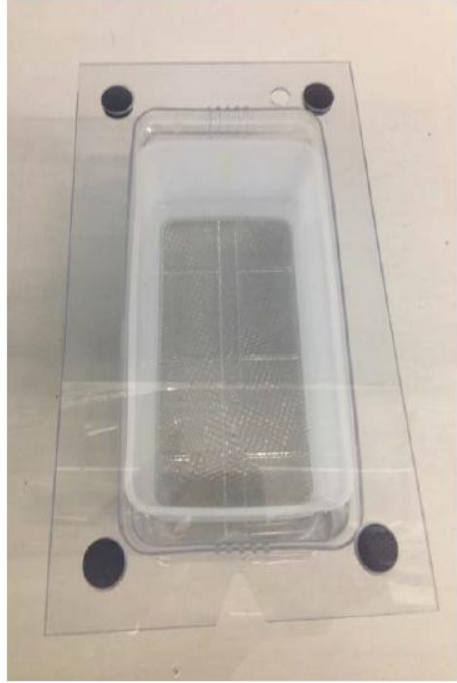

Set up fish late in the afternoon – they will wait with mating until the next morning

Or

Separate male and female, put them together early next morning – generates precisely dated eggs

Typical breeding cage for single couple

<https://www.youtube.com/watch?v=Wb1mEfACpY4>

<https://www.youtube.com/watch?v=PUNN7YzC4Zo>

<https://www.youtube.com/watch?v=-aecw9Hx3DU&t=5s>

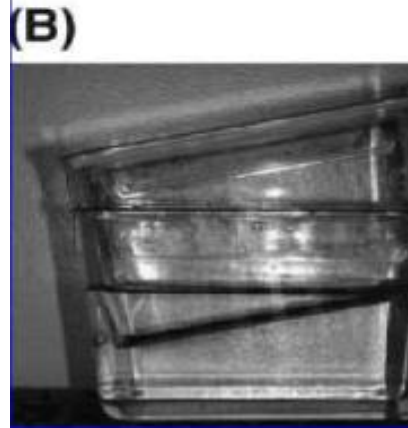
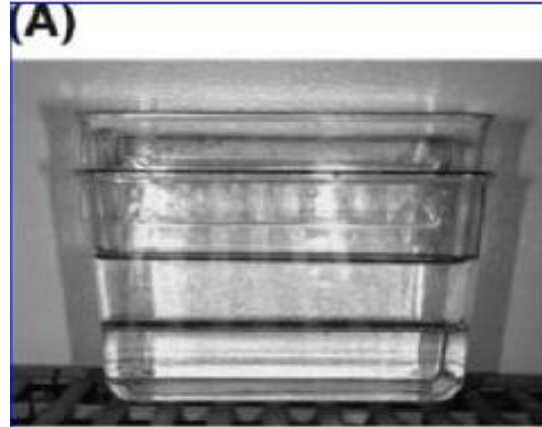

Mating – practical part

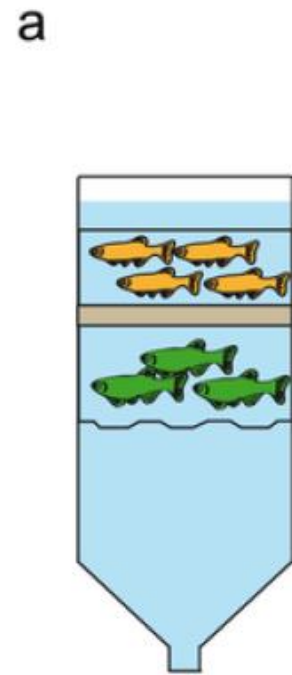
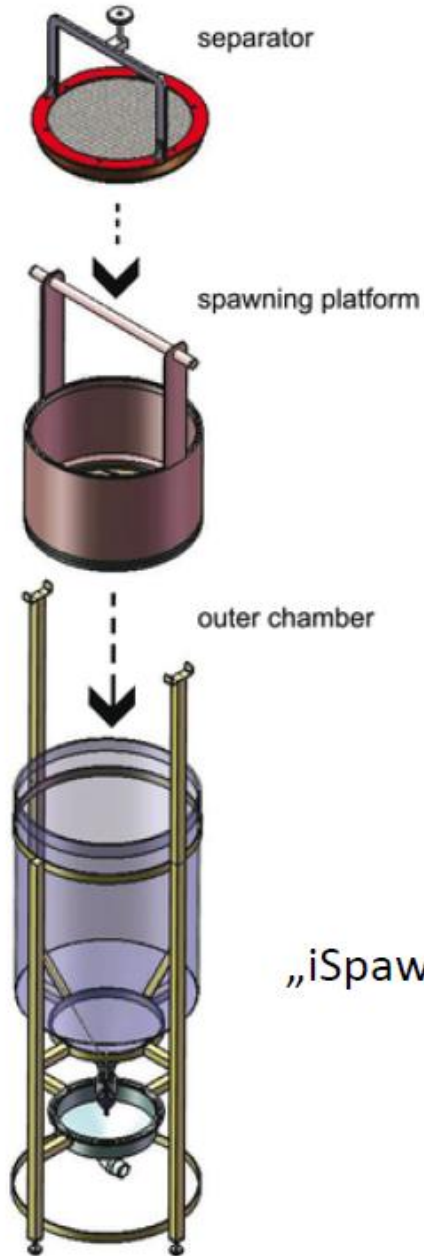

separation

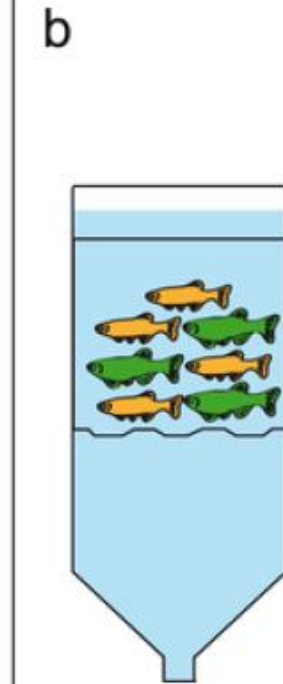

„sex on the beach“

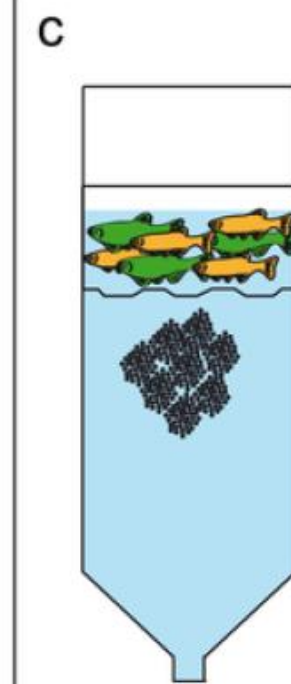

egg harvesting



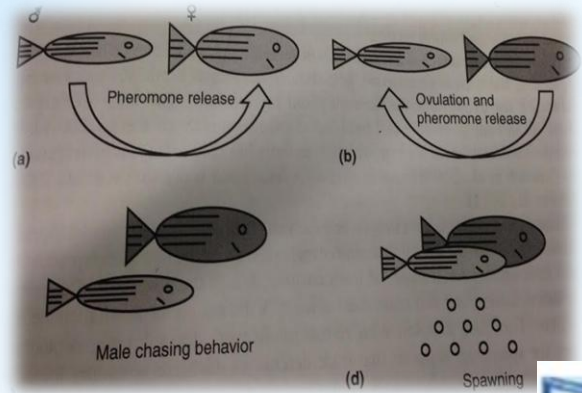

Comportamento riproduttivo dello zebrafish:

- (a) Rilascio dei feromoni maschili;
- (b) Ovulazione e rilascio feromoni femminili;
- (c) Esibizione del comportamento di corteggiamento del maschio;
- (d) Deposizione delle uova con fecondazione esterna



Breeding

Stimoli scatenanti la riproduzione: stimoli olfattivi (Ref: C. Lawrence) e contatto fisico.

RACCOLTA DELLE UOVA



Incubazione degli embrioni
Passaggio fondamentale spesso sottovalutato

Breeding
Raccolta degli embrioni

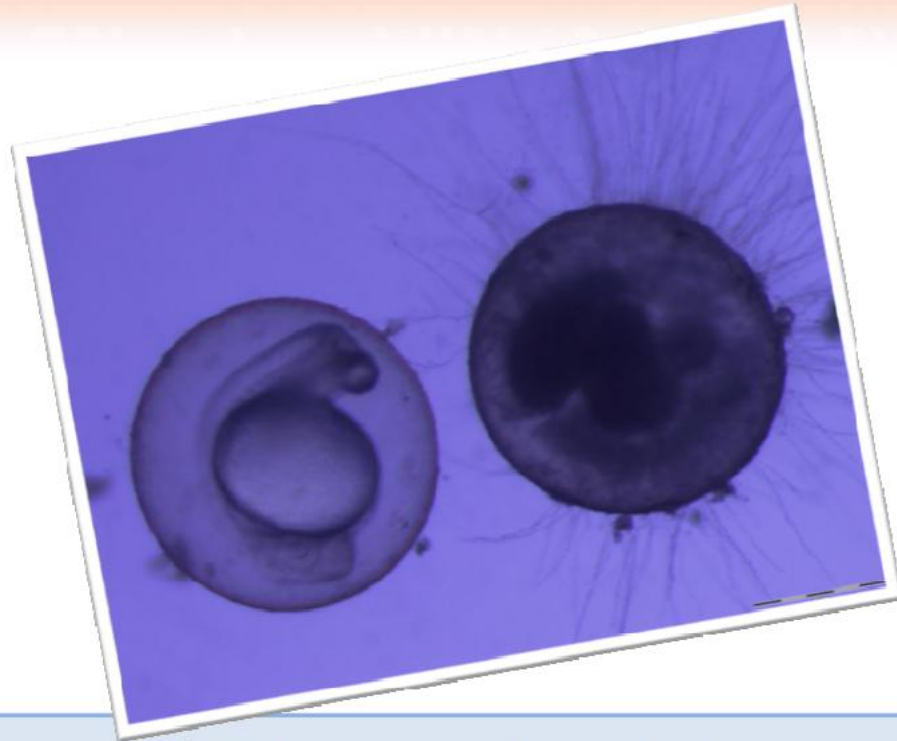

Incubazione degli embrioni

La loro cura è cruciale: infezioni fungine (saprolegnia)

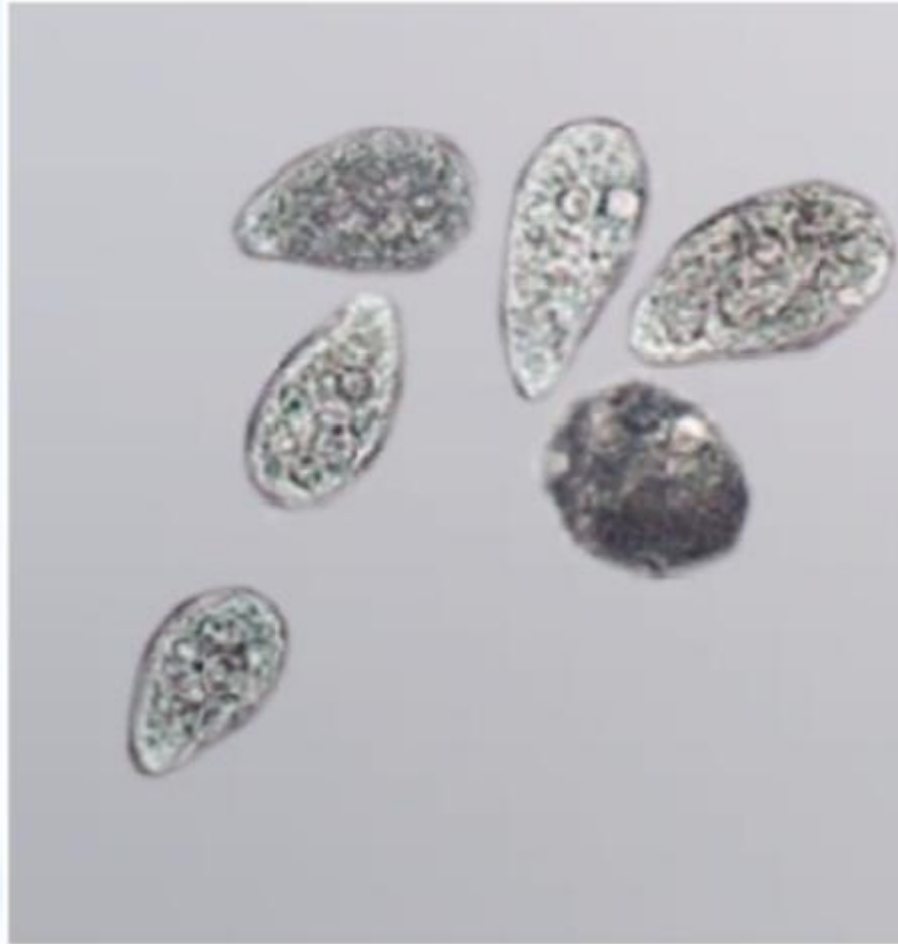

Incubazione degli embrioni

La loro cura è cruciale: protozoi (tetrahymena)

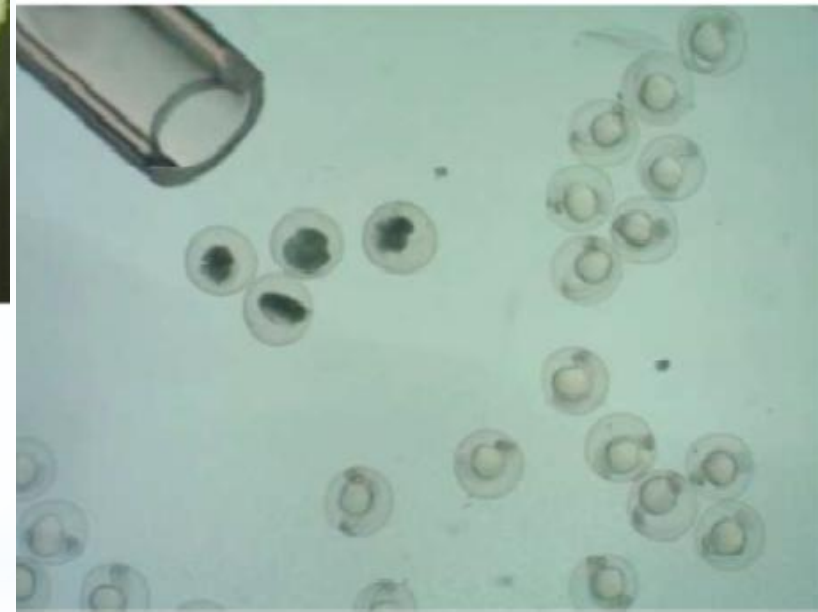
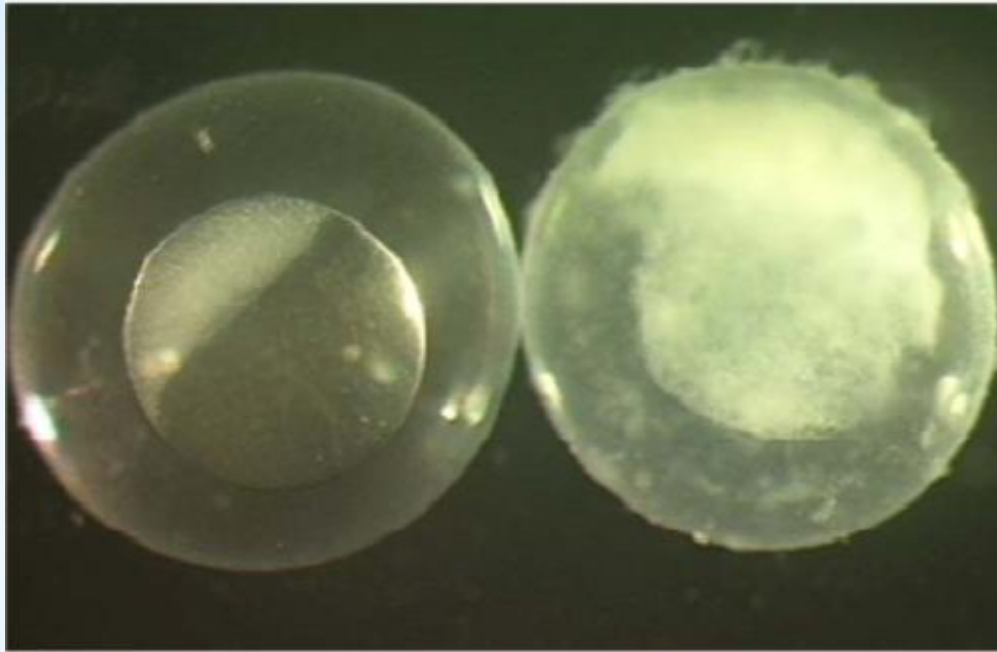

Incubazione degli embrioni
La loro cura è cruciale: Ipossia

<https://www.jove.com/video/4196/cura-e-manutenzione-periodiche-di-zebrafish?language=Italian>

Zebrafish: un modello nella ricerca



ZIRC

Zebrafish International Resource Center



Common Laboratory Fish in the US

- Japanese medaka
- Fathead minnow
- Guppy
- Goldfish
- Rainbow trout
- Channel catfish
- Nile tilapia
- Zebrafish



PubMed Results for “Zebrafish”

1970-2014

He's not just a fish.
He's hope.



This zebrafish can heal his own heart.
With your help, maybe we can heal ours too.



<i>Rank</i>	<i>Countries/Territories</i>	<i>Records</i>	<i>No. of institutes doing zebrafish research</i>	<i>Records/Institute</i>	<i>Percent^a</i>
1	USA	8196	877	9.35	47.625
2	Germany	1871	359	5.21	10.869
3	England	1393	180	7.74	8.094
4	Japan	1284	228	5.63	7.451
5	People's Republic of China	1151	255	4.51	6.703
6	Canada	902	113	7.98	5.243
7	France	877	219	4.00	5.098
8	Netherlands	501	77	6.51	2.914
9	Spain	449	138	3.25	2.601
10	Taiwan	431	84	5.13	2.509
11	Singapore	421	34	12.38	2.445
12	Italy	419	167	2.51	2.433
13	Australia	322	74	4.35	1.866
14	South Korea	275	99	2.78	1.593
15	Switzerland	251	54	4.65	1.454
16	Sweden	238	34	7.00	1.379
17	Belgium	215	47	4.57	1.246
18	Norway	208	43	4.84	1.211
19	Israel	180	30	6.00	1.043
20	Scotland	176	17	10.35	1.020
21	India	170	50	3.40	0.991
22	Brazil	151	51	2.96	0.875
23	Austria	131	27	4.85	0.765
24	Chile	103	16	6.44	0.597
25	Portugal	103	39	2.64	0.597

^aTotal percent is more than 100 because many articles have authors from different countries.



Legislazione italiana

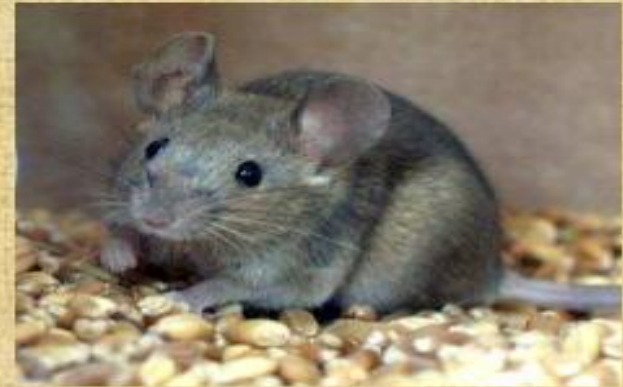

Decreto legislativo 4 marzo 2014, n. 26. Attuazione della direttiva 2010/63/UE sulla protezione degli animali utilizzati a fini scientifici. (14G00036) (GU Serie Generale n.61 del 14-3-2014). note: Entrata in vigore del provvedimento: 29/03/2014.

ALLEGATO I

Elenco degli animali di cui all'articolo 10, comma 1

1. Topo (*Mus musculus*)
2. Ratto (*Rattus norvegicus*)
3. Porcellino d'India (*Cavia porcellus*)
4. Criceto siriano (o dorato) (*Mesocricetus auratus*)
5. Criceto cinese (*Cricetulus griseus*)
6. Gerbillo della Mongolia (*Meriones uingiculatus*)
7. Coniglio (*Oryctolagus cuniculus*)
8. Cane (*Canis familiaris*)
9. Gatto (*Felis catus*)
10. Tutte le specie di primati non umani
11. Rana [*Xenopus (laevis, tropicalis)*, Rana (*temporaria, pipiens*)]
12. Pesce zebra (*Danio rerio*)

Art. 1 -Oggetto e ambito di applicazione

a) animali vertebrati vivi non umani, comprese:

1.forme larvali capaci di alimentarsi autonomamente

2.forme fetali di mammiferi a partire

dall'ultimo terzo del loro
normale sviluppo;

a) cefalopodi vivi.



UNITE

Stabilimento utilizzatore per la specie zebrafish

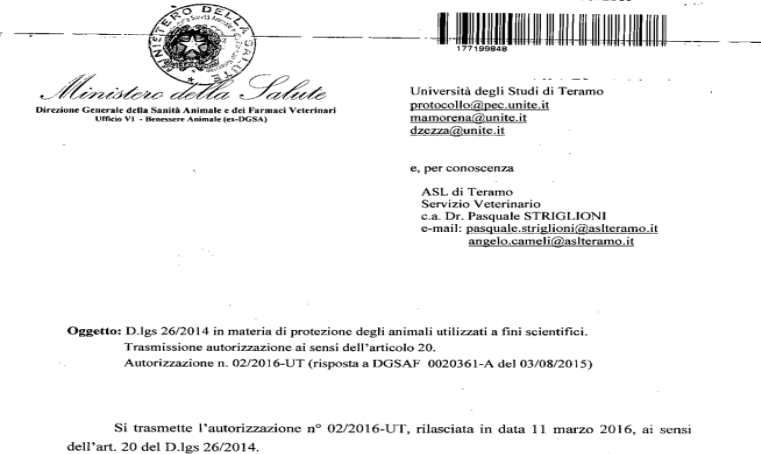

Stabilimento allevatore per la specie zebrafish



* Allevamento/vantaggi

Facilità manipolazione embrioni per creare linee transgeniche

Alta densità di allevamento

Taglia piccola e resistente

Elevata produzione di uova

In laboratorio

Longevo (2 anni)

Uova facilmente manipolabili

Bassi costi di mantenimento

Disponibilità di oltre 1000 linee transgeniche



17/04/2013 Genoma sequenziato viene reso pubblico

1. Rapid development

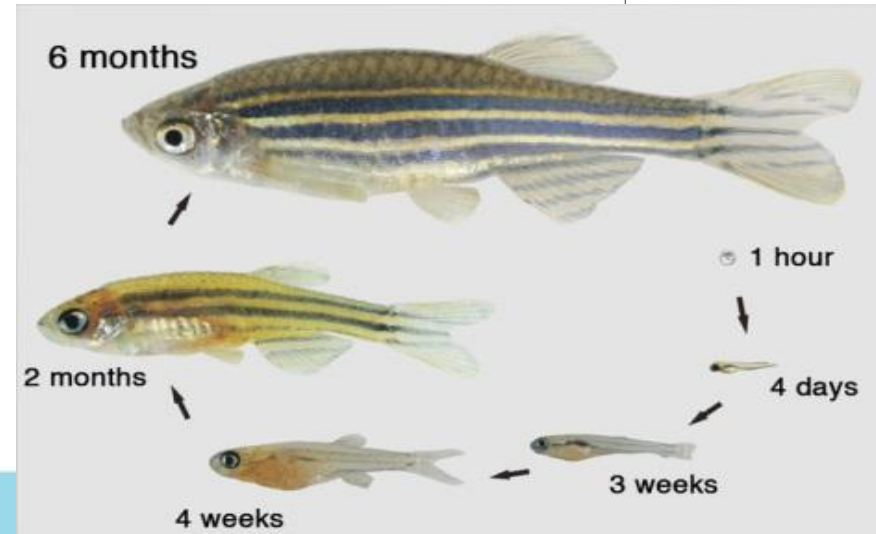
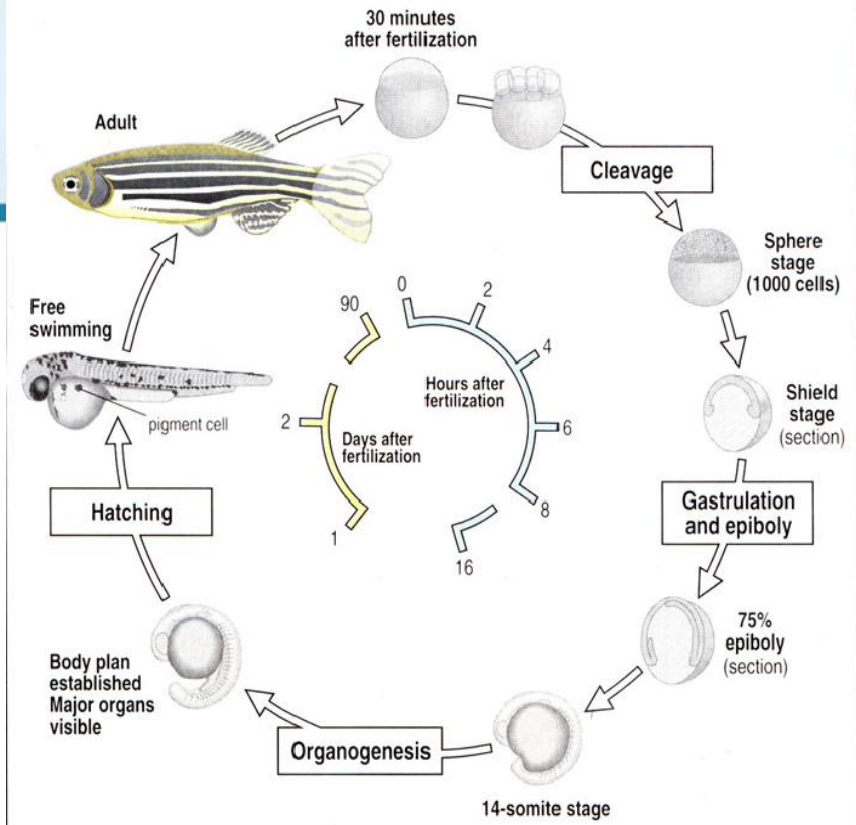
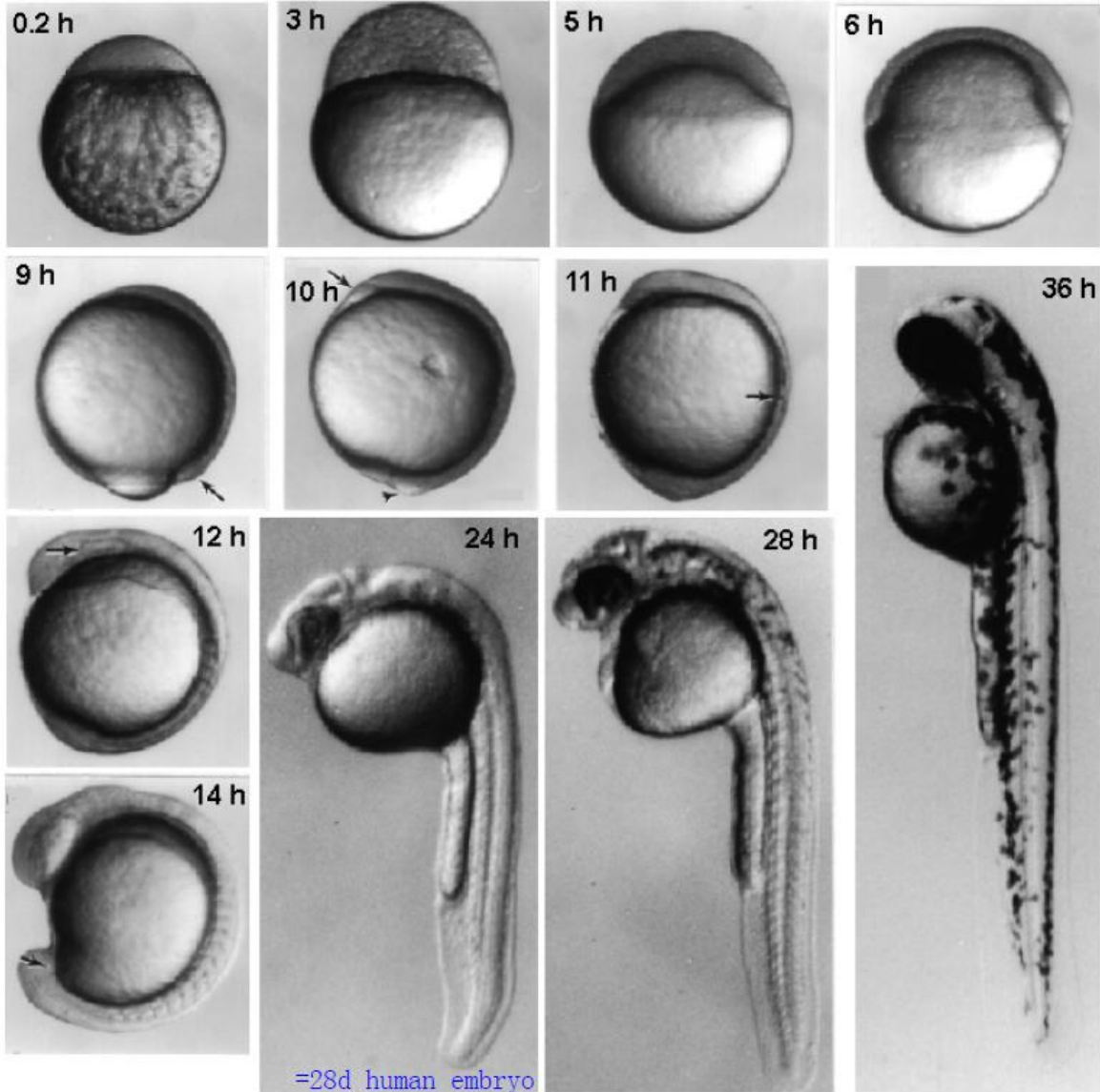



2. High reproductivity

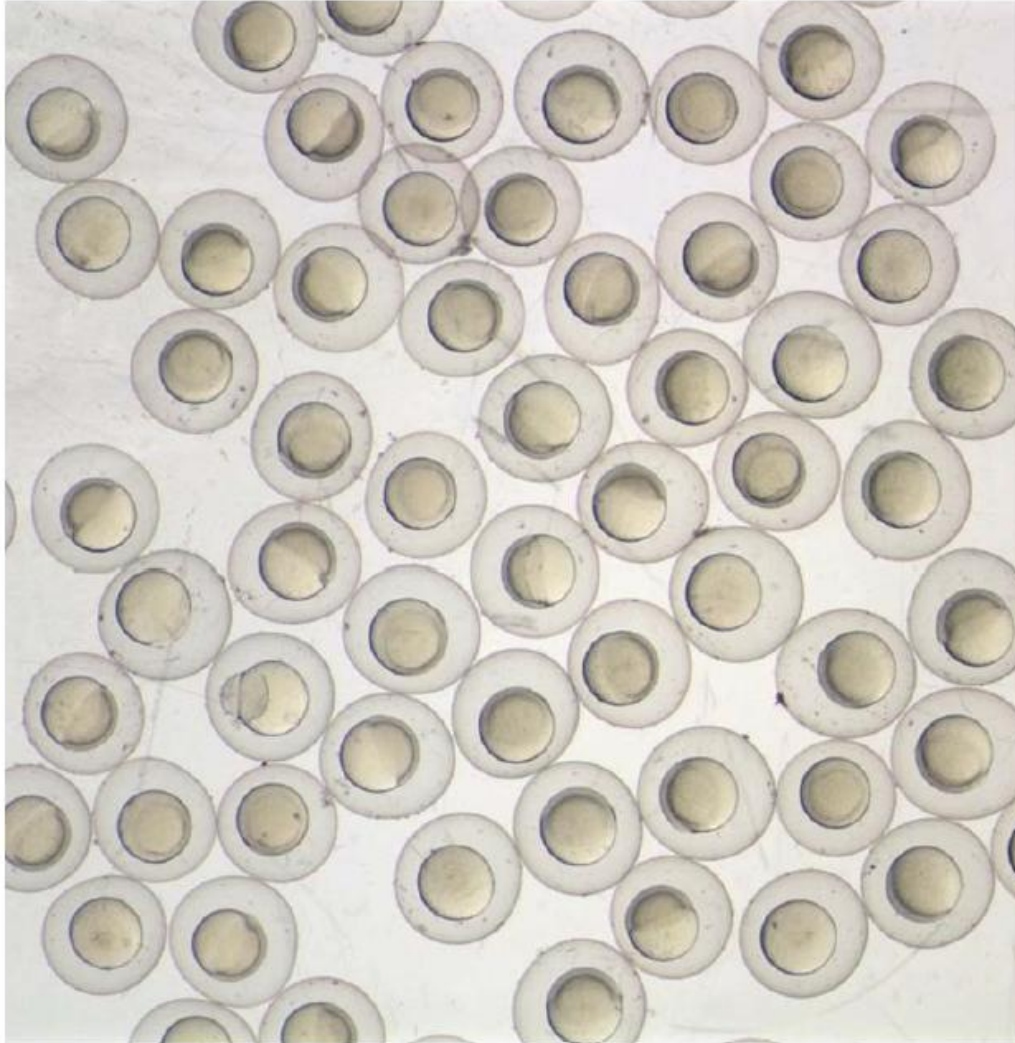

- 🧠 A few hundreds of eggs per female
- 🧠 Laying weakly
- 🧠 Controllable laying time
- 🧠 External fertilization and development
- 🧠 Transparent embryos for easy observation



3. Small size and easy raising



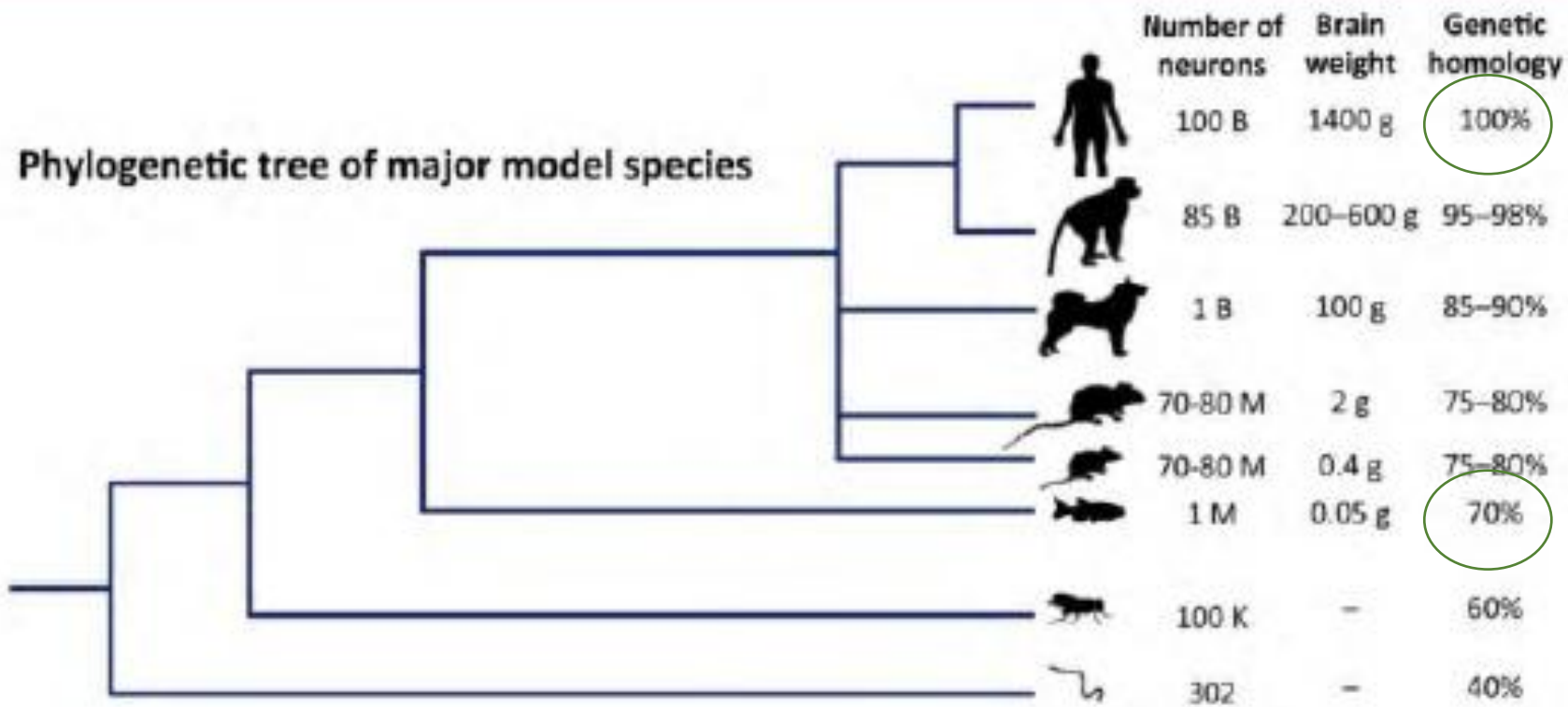

adapted by Stewart et al., Trends Neurosci., 2014

- **condivide comuni pathways molecolari con i mammiferi**
 - **prole numerosa**
 - **sviluppo extrauterino**
 - **corion trasparente**
 - **crescita rapida**
 - **tempi di generazione molto rapidi**
 - **bassi costi di gestione**



Zebrafish è davvero il “nuovo” roditore da laboratorio?



1980

primo topo
transgenico

2002

genoma
sequenziato

ATTUALMENTE

E

Principale modello
impiegato
nella ricerca
biomedica.



2001

progetto
genoma
“zebrafish”

2013

genoma
sequenziato

ATTUALMENTE

E

Numerosissime
linee transgeniche
disponibili.

Zebrafish : **i limiti del modello nella ricerca biomedica**

Duplicazione del genoma

Alcuni organi/tessuti nei mammiferi non sono presenti in zebrafish: es.: polmoni, prostata, tessuto mammario.

**Scarsa
caratterizzazione
dei ceppi inbred
rispetto ai roditori**

Molecole liposolubili non possono essere somministrate per immersione in acqua a meno che non siano associate a solventi

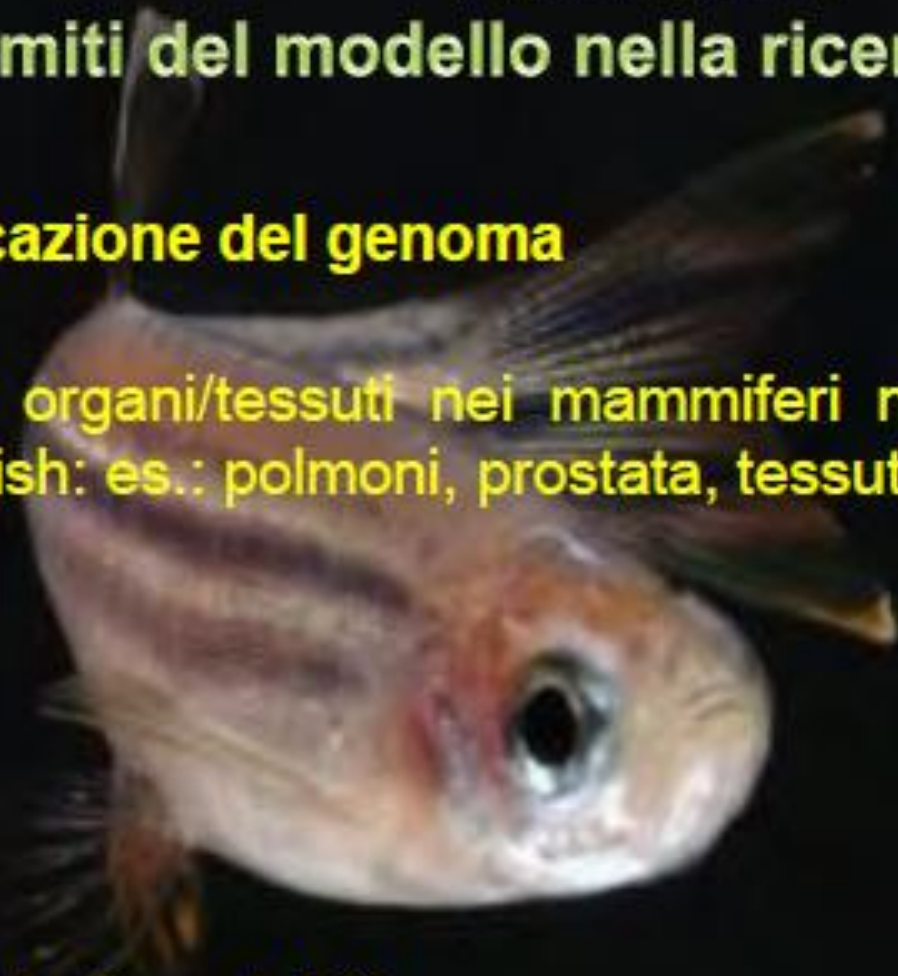

Zebrafish as Human Disease Models

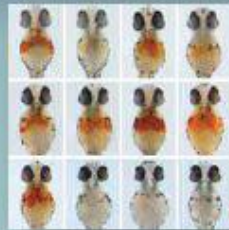

Congenital anemias

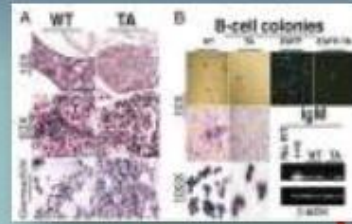

Acute lymphoblastic leukemia

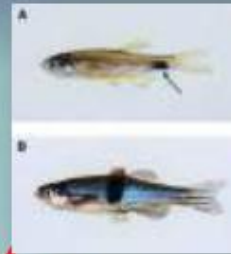

Melanoma



Coloboma, glaucoma, retinal degeneration

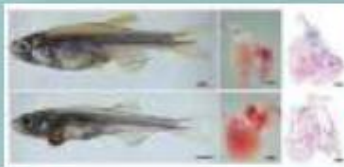

Dilated cardiomyopathy

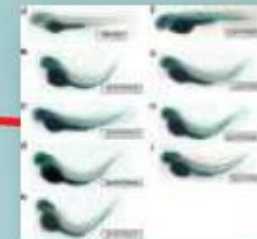

Neurodegenerative diseases

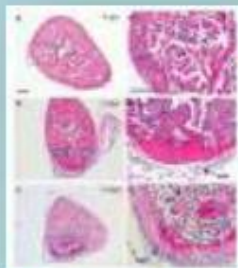

Myocardial infarction

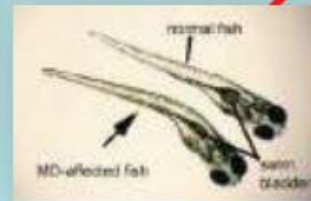

Muscular dystrophy



Obesity and aging



Polycystic kidney disease

PATOLOGIE UMANE: ANALOGIE CON LO ZEBRAFISH

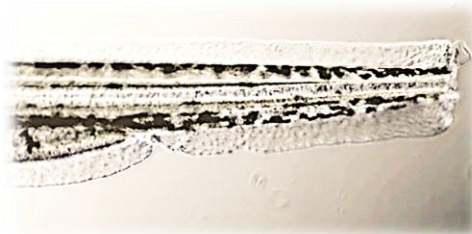
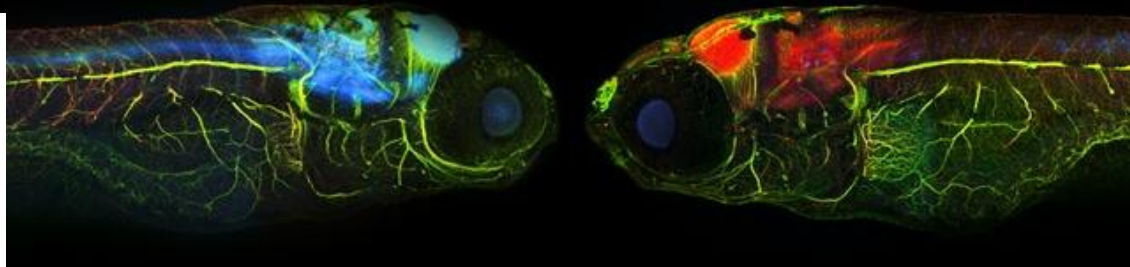

Guarigione
delle ferite

Interazione
patogeno-ospite

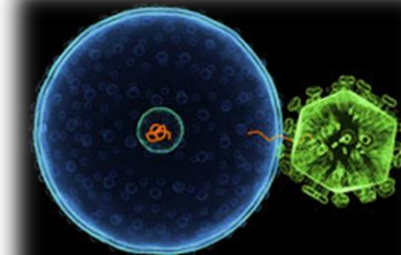

Malattie
gastrointestinali

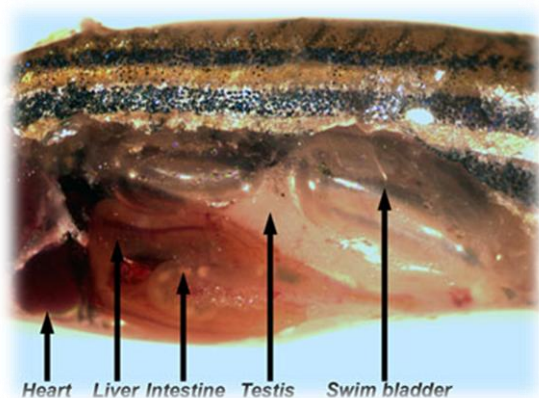

Malattie
genetiche

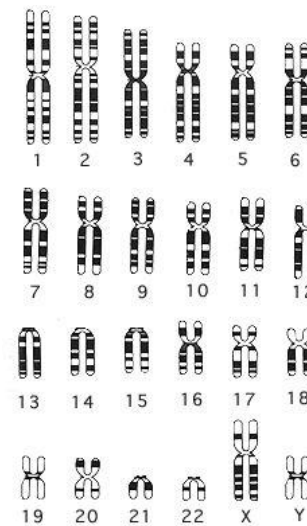
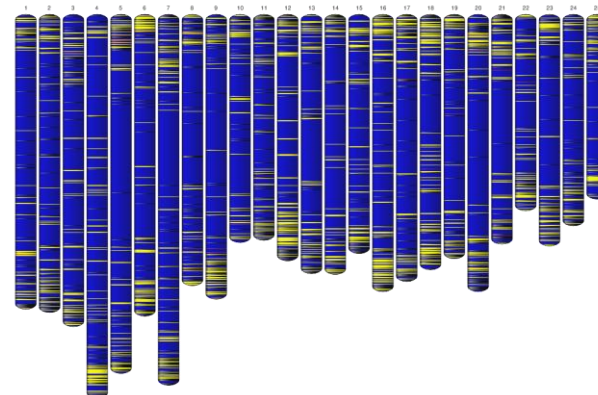

ZEBRAFISH: UN MODELLO PER LA TOSSICOLOGIA

VANTAGGI:

- ❖ Accesso immediato a tutte le fasi di sviluppo
- ❖ Analisi in tempo reale delle patologie

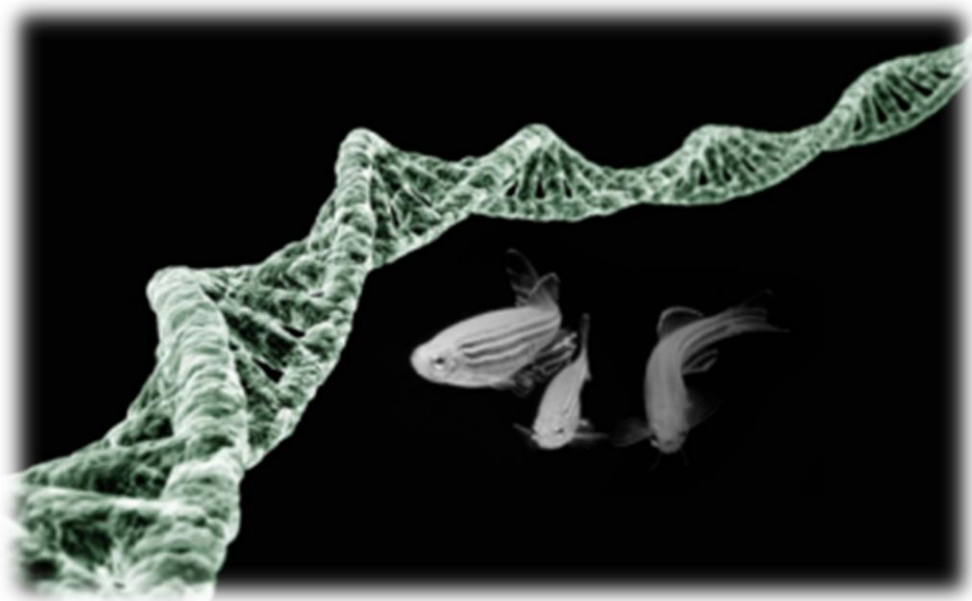

- **APPROCCI DI GENETICA DIRETTA**

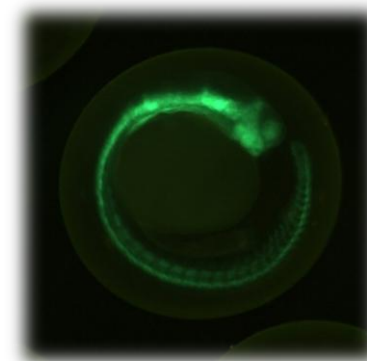

- **APPROCCI DI GENETICA INVERSA**

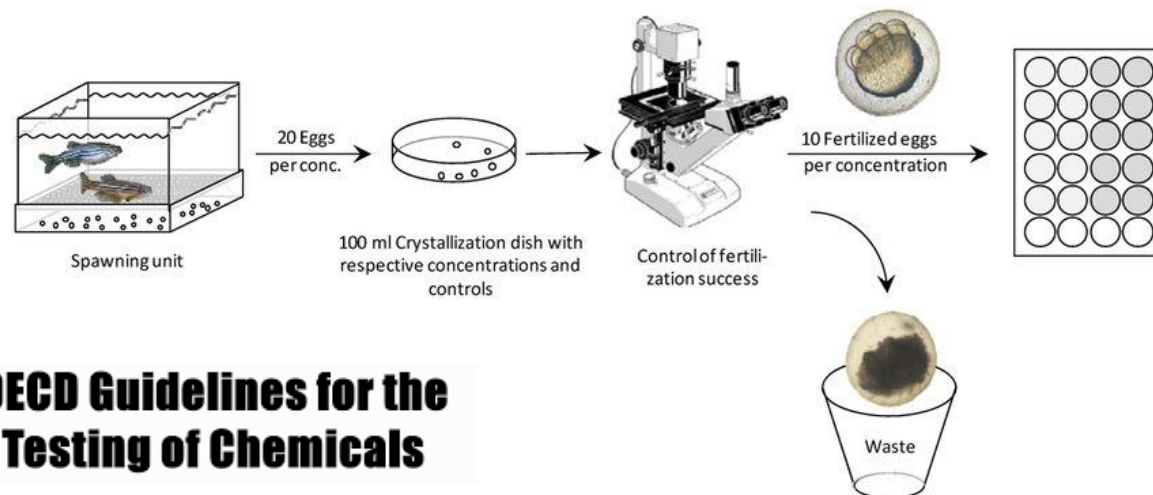

OECD Guidelines for the Testing of Chemicals

STUDI TOSSICOLOGICI

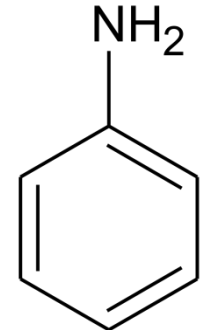
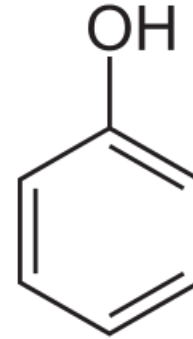

OECD TG 236: Fish Embryo Acute Toxicity test



GLI INTERFERENTI ENDOCRINI

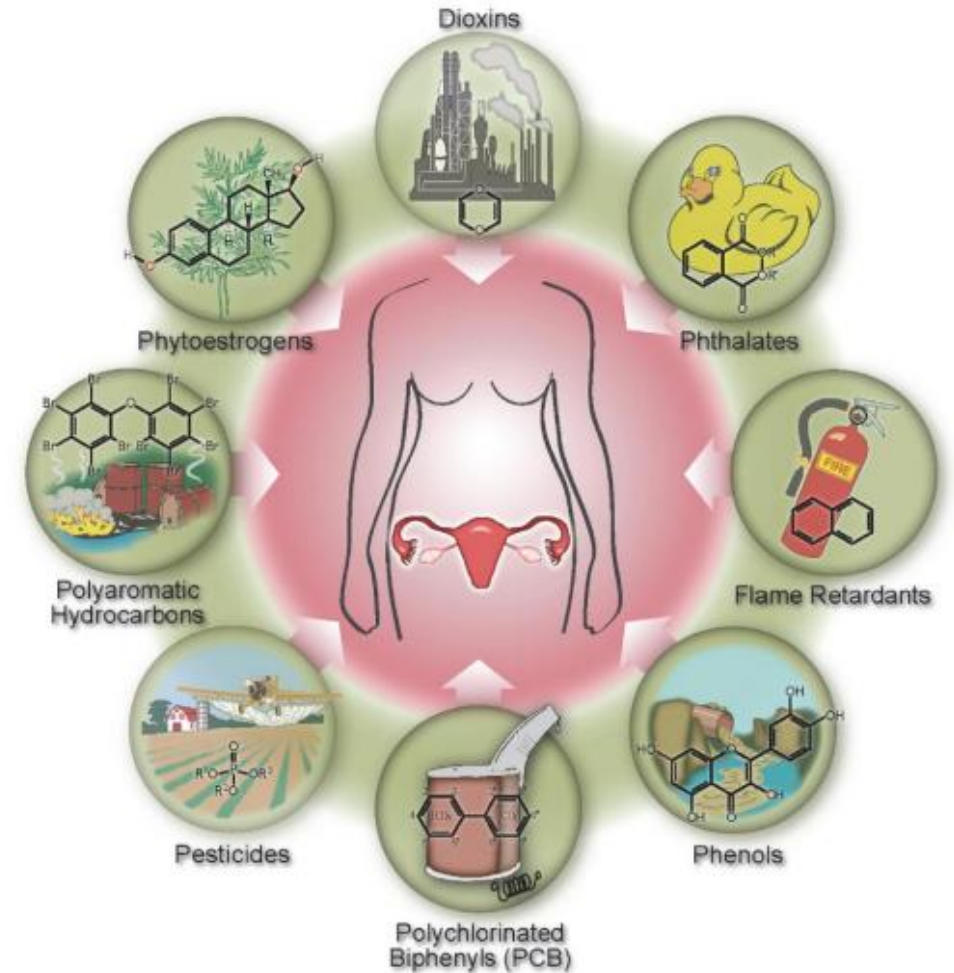
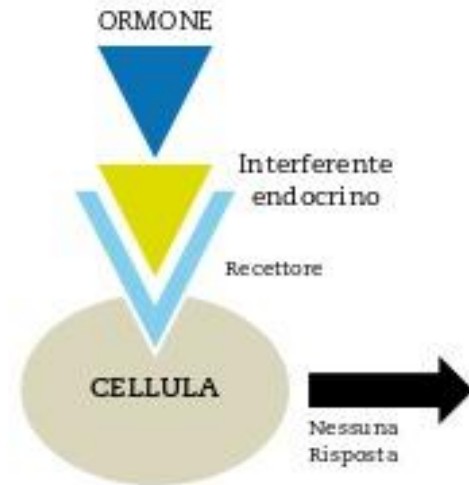
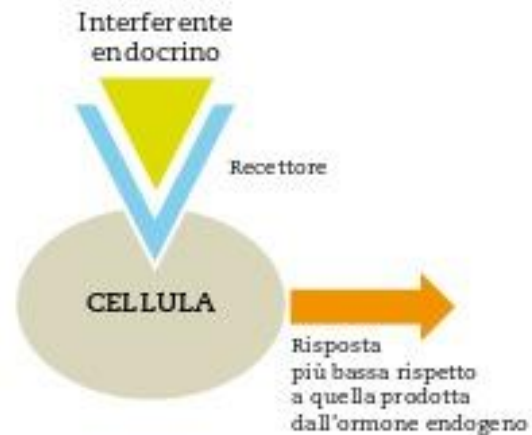
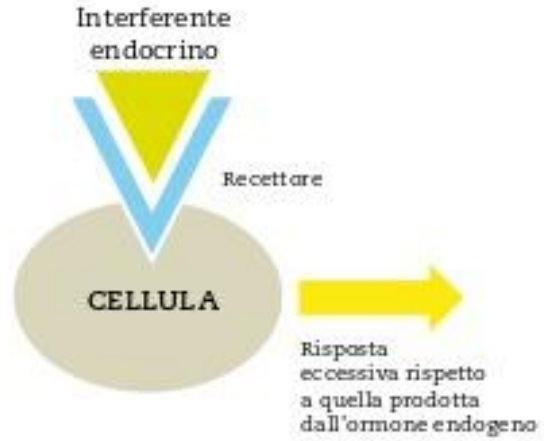
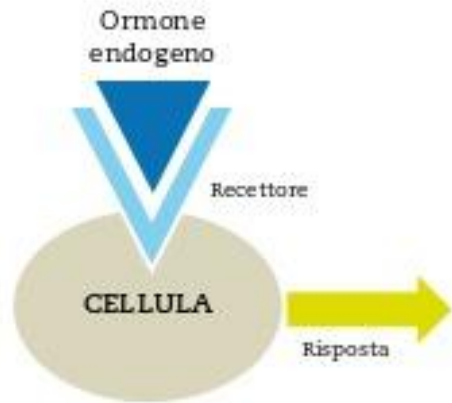

EFFETTI LETALI

LD 50 (Lethal Dose 50)

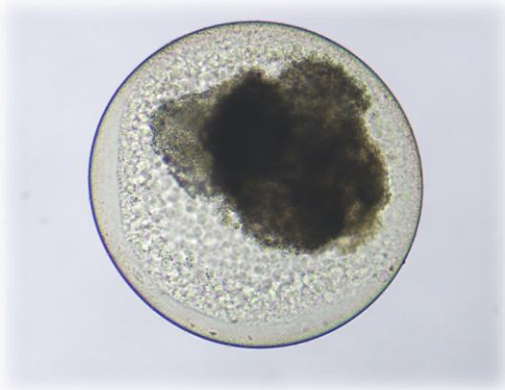

Coagulazione
dell'embrione

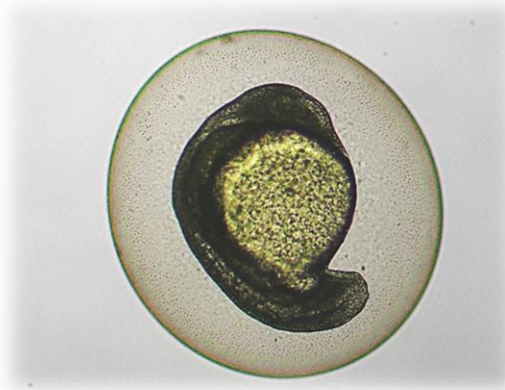

Mancato distacco della
coda (Acido Valproico)

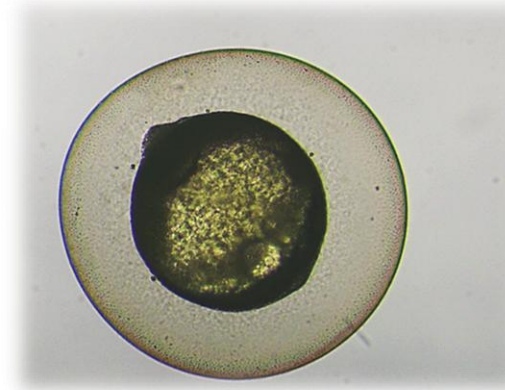

Mancata formazione dei
somiti (Acido Valproico)

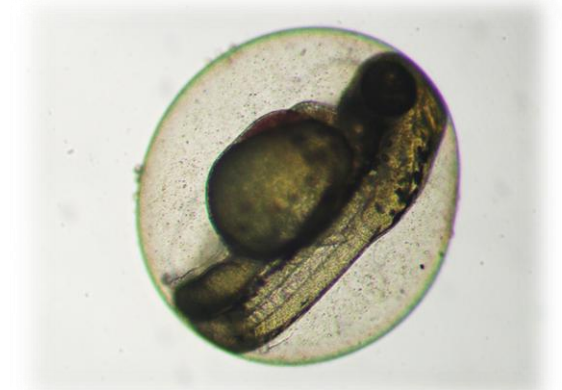

Assenza di battito cardiaco
(valutabile a 48 hpf tramite sistema video,
Triclosan)

LOEC (Lowest Observed Effect Concentration)

NOEC (No Observed Effect Concentration)

EFFETTI SUBLETALI

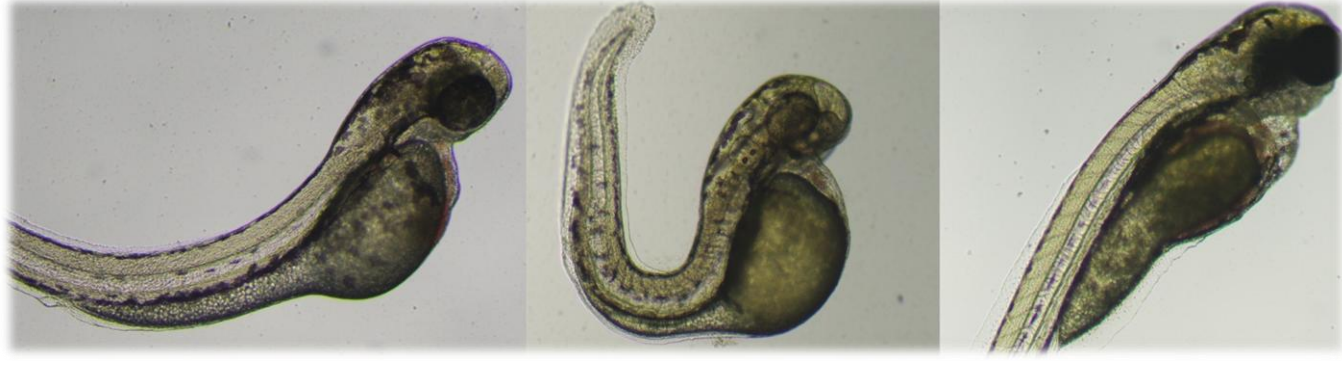
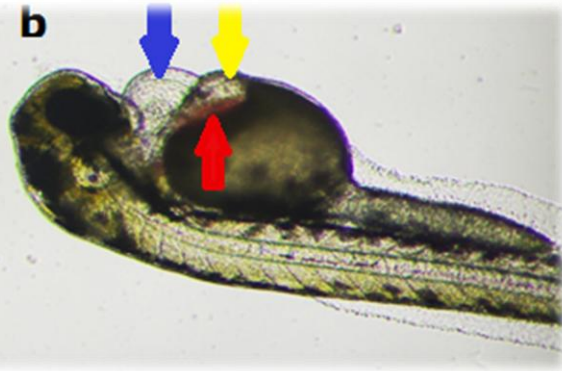

a) Controllo (larva schiusa a 72 hpf)

b) Larva esposta (Triclosan):

- Riduzione dimensione della testa
- Depigmentazione dell'occhio
- Edema del pericardio (freccia blu)
- Edema dello yolk (freccia gialla)
- Stasi ematica (freccia rossa)

Alterazioni della colonna vertebrale (Prodotti per la cura personale: Triclosan, Triclocarban)

EFFETTI SUBLETALI



Alterazioni nella dimensione della testa:

A) Microcefalia (prodotti per la cura personale: Triclosan, Triclocarban)

B) Controllo

C) Macrocefalia (Acido valproico)

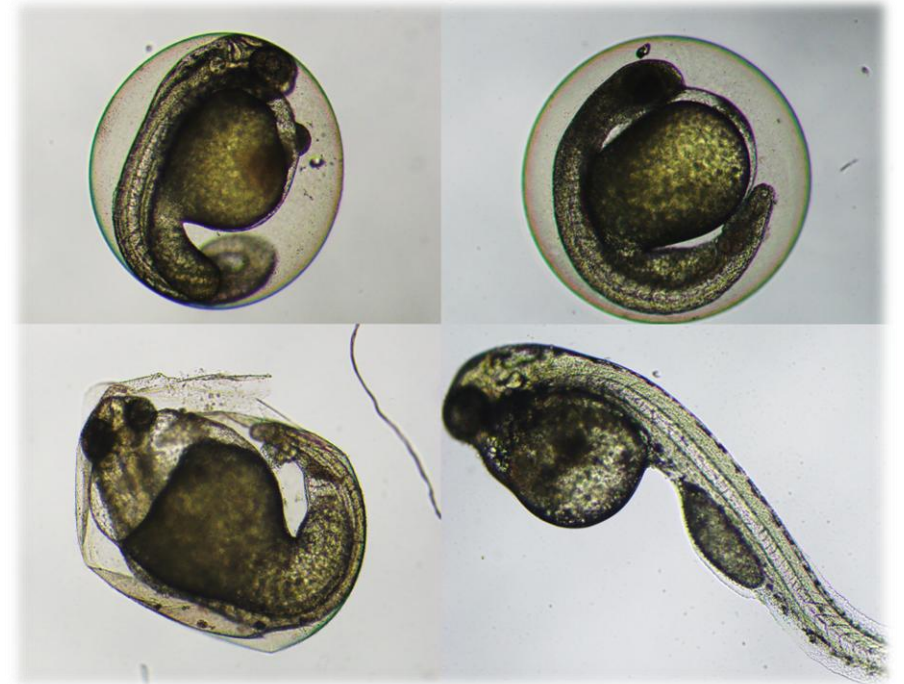

Deformità ed aumento di volume dello yolk (Propylparabene).

EFFETTI SUBLETALI

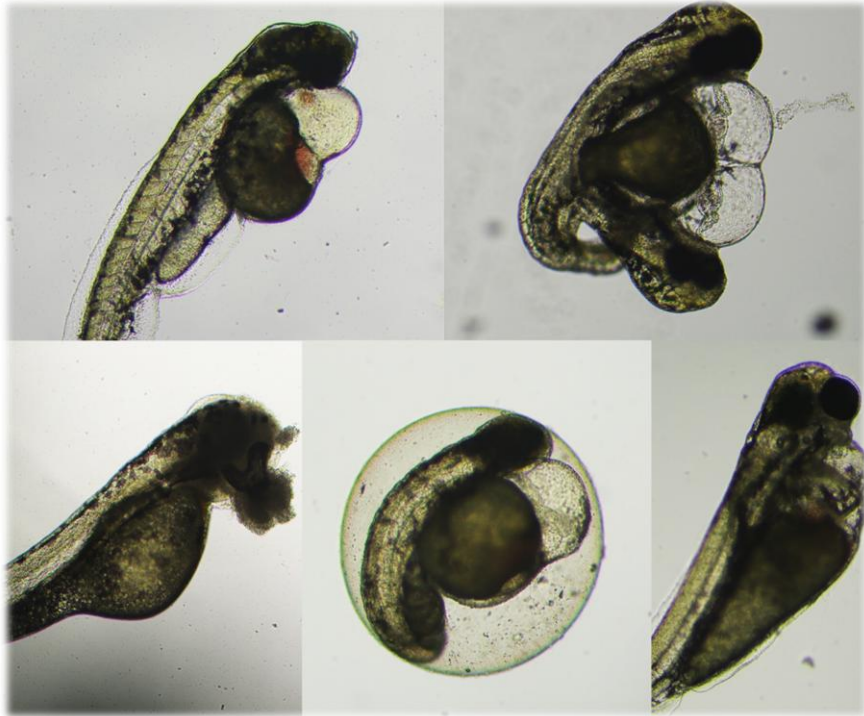

Testa deformata (più altre alterazioni subletali, prodotti per la cura personale: Triclosan, Triclocarban; alterazioni dello sviluppo)

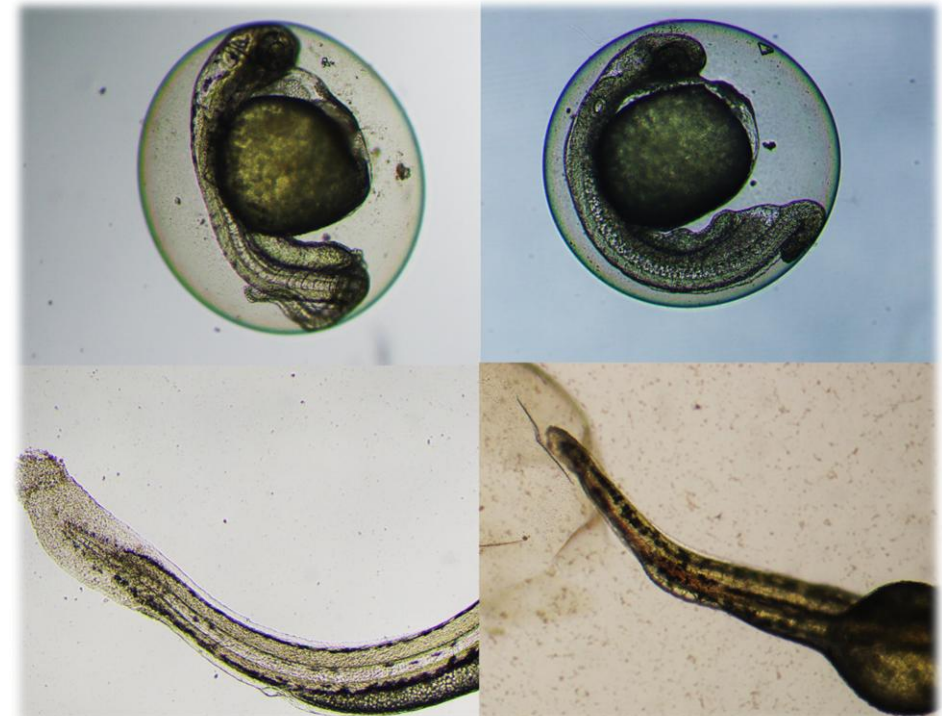

Deformità della coda (prodotti per la cura personale: Triclosan, Triclocarban).

FET Test – procedura



Danio rerio wild
tipe AB strain

Condizioni di validità:

Fecondazione delle uova raccolte $\geq 70\%$

T = 26 ± 1 °C

Mortalità embrioni nel controllo $< 10\%$ a 96h

Controllo positivo: mortalità $> 30\%$ a 96h

Schiusa nel controllo $\geq 80\%$ a 96h

Ossigeno disciolto $\geq 80\%$ satur. a 96h (nella max concentrazione e controllo)

OECD guidelines no. 236